

IDR480 Series

480 Watts

- Market leading slim design
- 94% efficient
- Output adjust
- DC OK LED and DC Low LED
- Operating temperature –25 to 70°C
- TS35/7.5 and TS35/15 DIN rail
- 3 Year warranty



The IDR480 series of DIN rail power supplies provide 480W of power in a slim 60mm package. The units are fully featured with built in EMI filter and over voltage, over current and short circuit protections. Outputs available; 24 or 48V and every unit comes with a FIDUS 3 year warranty.

Dimensions:

2.36 x 5.12 x 4.92" (60 x 130 x 125mm)

Models & Ratings

INSTALLATION ADVICE PG4

Model Number	Output Power	Output Voltage	Output Current	Efficiency ⁽¹⁾
IDR48024	480W	24V	20A	94%
IDR48048	480W	48V	10A	94%

Notes

1. Efficiency at 100% load, 25°C, 230VAC input.

Key specifications

Parameter	Minimum	Typical	Maximum	Units	Notes & Conditions
AC Input range	90		264	VAC	Derates from 110VAC to 90VAC at 1% per Vac
Operating temperature	-25		70	°C	Derate linearly 2.6% per °C from 55 to 70°C 240Vac. Derate linearly 2% per °C from 50 to 70°C 110Vac
Efficiency	94% typical at full load, 115/230VAC				
Dimensions	2.36 x 5.12 x 4.92" (60 x 130 x 125mm)				
EMC	EN55032 Level A conducted and radiated. EN61000-3 and EN61000-4, harmonics, flicker, Surge, EFT, ESD, conducted and radiated EN55024				
Safety	IEC60950-1, UL60950-1, CSA-C22.2 No.60950-1, CE				

Input

Parameter	Minimum	Typical	Maximum	Units	Notes & Conditions
AC Input range	90		264	VAC	Derates from 110VAC to 90VAC at 1% per Vac
AC Input Frequency	47		63	Hz	
Power factor	0.97		0.99		EN61000-3-2 class A compliant, minimum at 115VAC
On delay			3.6	s	Full load 115VAC
No load power consumption			5	W	At 230VAC
Earth leakage			0.75	mA	
Input current (rms)		5		A	At 115VAC
		2.5			At 230VAC max
Inrush current ⁽²⁾		40		A	115VAC cold start at 25°C. Inrush limiting circuit (2)
		80			230VAC cold start at 25°C. Inrush limiting circuit (2)

Notes

2. Malfunction may occur if the input voltage is cycled repeatedly due to the inrush limiting circuit. Please avoid rapid, repeated power cycling.

Output

Parameter	Minimum	Typical	Maximum	Units	Notes & Conditions
Output voltage adjustment	24V: 22-27V, 48V: 43-52V			V	Power output not to be exceeded
Setpoint accuracy			±2	%	
Line regulation			±2	%	100VAC-240VAC
Load regulation			±3	%	Min to max load
Minimum load	0			%	
Ripple & Noise			1%	%	All models measured with 0.1uF ceramic and 47uF electrolytic capacitor and 20 MHz bandwidth. At 230VAC and full load
Hold up time		20		ms	At full load, 115VAC
Overload protection		30A / 15 A		A	Hiccup mode. 30A for 24V and 15A for 48V
Short circuit protection					Trip and restart. Automatic recovery
Overvoltage protection		32 / 62		V	Latch reset. 32V for 24V and 62V for 48V
Over Temp protection		110 ±10		°C	Trip and restart. Automatic recovery
DC LOW LED	DC LOW LED light will be ON when output voltage is below 85%(±2.5%), over voltage, over current, over temp and short circuit.				

General

Parameter	Minimum	Typical	Maximum	Units	Notes & Conditions
Efficiency		94		%	
Isolation: Input to Output	3000			VAC	
Input to Ground	1500			VAC	
Output to Ground	500			VAC	
Isolation resistance			100	MΩ	500VDC
Power density		8		W/In ³	
MTBF		230		KHrs	As per MIL-HDBK-217F, 25°C, 220VAC
Weight		1000		g	

Environmental

Parameter	Minimum	Typical	Maximum	Units	Notes & Conditions
Operating temperature	-25		70	°C	Derate linearly 2.6% per °C from 55 to 70°C 240Vac. Derate linearly 2% per °C from 50 to 70°C 110Vac
Storage temperature	-40		85	°C	Humidity 5-95% RH
Cooling					Natural convection
Humidity	20		95	% RH	Non condensing
Mounting orientation	Vertical only				

Derating curve

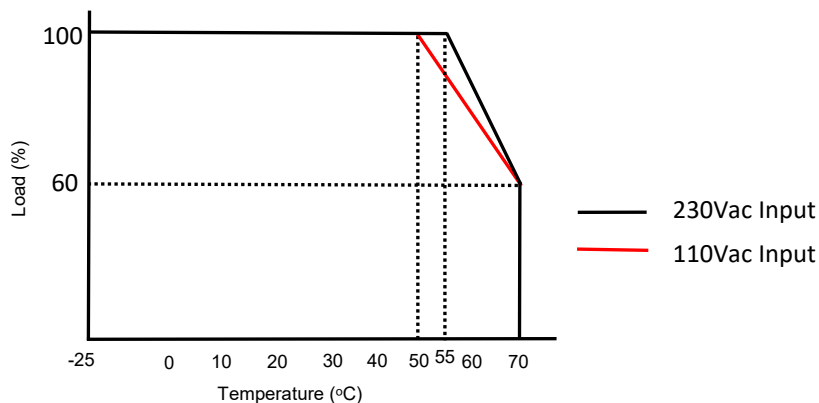

IDR480 Series

EMC: Emissions

	Standard	Test level	Criteria	Notes & Conditions
Conducted	EN55032	A		
Radiated	EN55032	A		
Harmonic current	EN61000-3-2	Class A		Also, Class D compliant
Voltage flicker	EN61000-3-3			

EMC: Immunity

	Standard	Test level	Criteria	Notes & Conditions
ESD	EN61000-4-2	2/3	A	Contact 4KV, Air 8KV
Radiated	EN61000-4-3	2	A	3V/M 80-1000MHz 80%AM 1Khz
EFT	EN61000-4-4	3	A	2KV at 5KHz 120sec
Surges	EN61000-4-5	Installation Class 3	A	Line to line 1KV, Line to PE 2KV
Conducted	EN61000-4-6	3	A	10V 0.15-80MHz, 80%AM 1KHz
Dips and Interruptions	EN61000-4-11		AAB	>100% dip, 30% dip and interruptions

Safety Approvals

	Safety standard	Notes & Conditions
UL	UL60950-1	
CB	IEC60950-1	
CE		2011/65/EU RoHS Directive and 2006/95/EC Low voltage directive
Equipment protection class		Class I

Mechanical Details

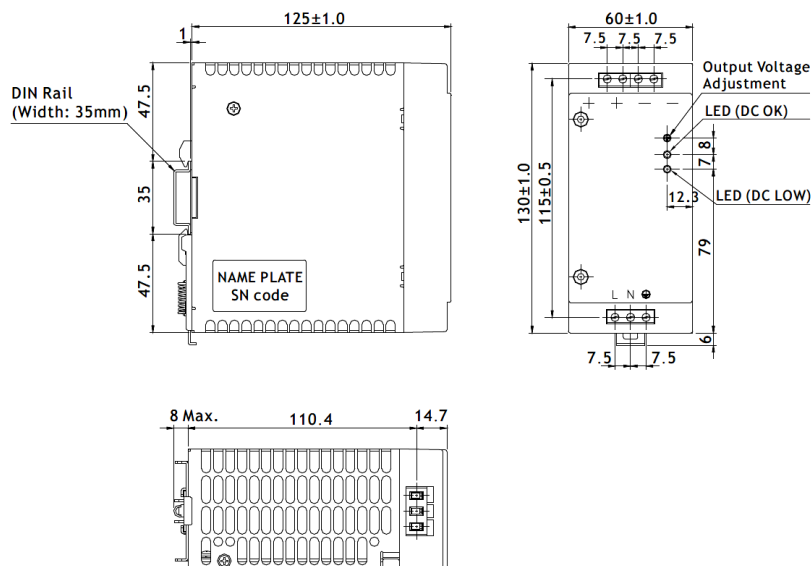

Notes

1. All dimensions shown in millimetres (mm)
2. Tolerance: ± 1 mm

Installation Advice

Series Operation

Series connection is possible as per below diagrams. Current draw should be no higher than the lowest power unit

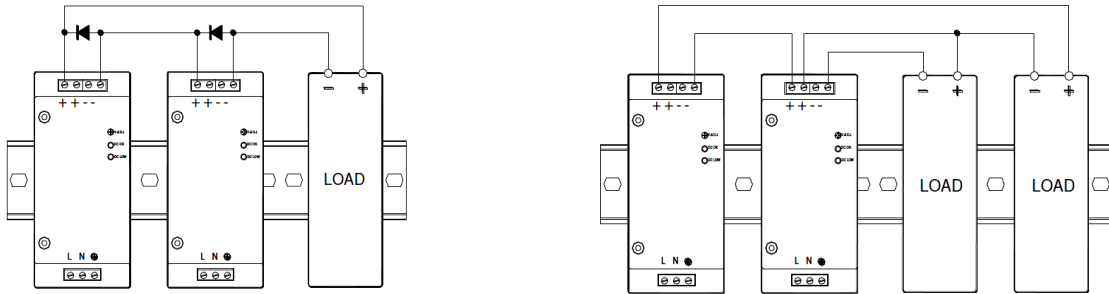

Parallel Operation

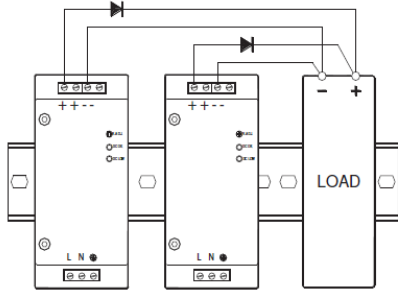

Parallel operation is possible as per drawing. Only identical units can be used in this way. Do not mix powers or voltages.

Parallel operation is for redundancy only, not for increased load capability.

Select diodes with appropriate voltage drop (V_f), output voltage (V_o) and current capacity (I_o)

Thermal Consideration

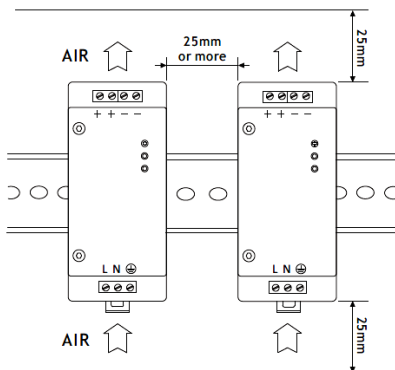

For best thermal performance allow for ventilation either side of the unit to neighbouring power supply units and above and below the unit as per diagram. Spacing can be reduced with forced air cooling.

Notes

1. When using multiple units, be aware that the cumulative affect of EMC filter drain will increase earth leakage currents

Block Diagram

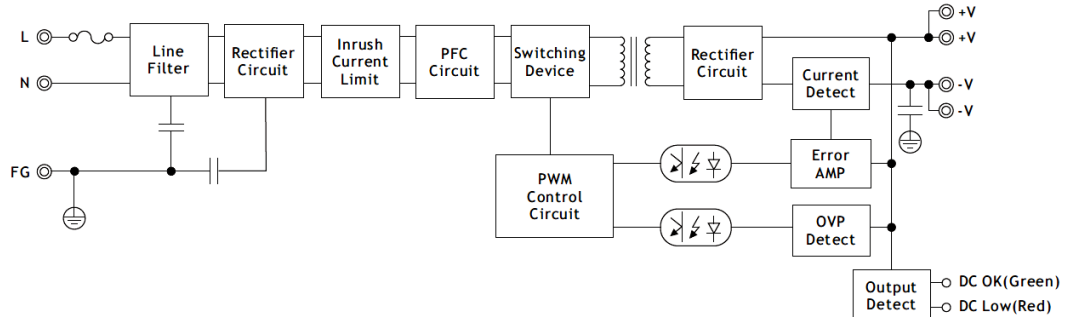

DIN Rail mounting /removal

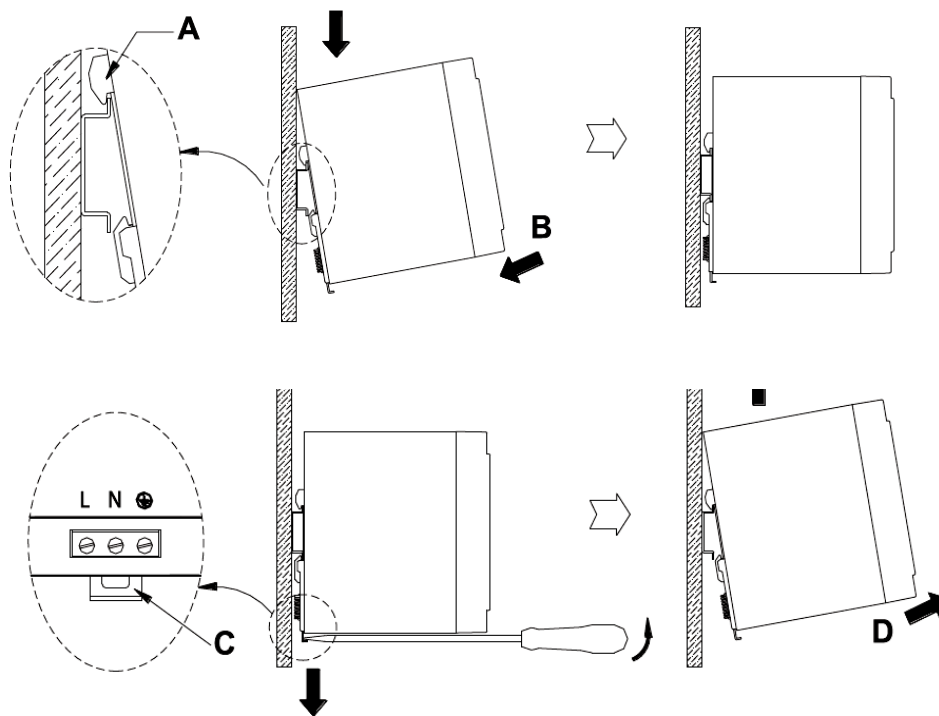

Notes

1. The earth terminal must always be connected prior to use for electrical safety and EMC compliance.
2. Be cautious of falling debris –wire strands / swarf, as this will cause serious damage to the unit.
3. Suitable for TS35/7.5 and TS35/15 DIN rail.
4. Wire size accepted by terminals <math>< 2.5\text{mm}^2</math> (AWG12).