

MVPS800 Series

800 Watts

- 5 x 8.5" Footprint, 1.61" for 1U installation
- Latest medical approvals IEC 60601-1 (3.1) IEC 60601-1-2 (4th)
- Up to 3 units load share for higher powers
- Peak of 1000W for 500mS
- EN55011 Level B conducted & radiated
- 3 Year warranty



Dimensions:

5 x 8.5 x 1.61" (127 x 216 x 40.9mm)

The MVPS800 series of low profile, medically approved AC-DC power modules offer 300-800W in a 5" x 8.5" package conforming to the latest IEC60601-1 3.1 and IEC60601-1-2 4th ed standards. The units are fully featured including 5V 1.5A auxiliary output and low standby power of 3W. The units are body floating (BF) rated for applied part applications. They have a wide operating temperature of -40 to 70°C, in a range of voltages from 12V to 58V. All units come with a FIDUS 3 year warranty.

Models & Ratings

INSTALLATION ADVICE PG6

Model Number ⁽¹⁾	Output Power ⁽²⁾	Output Voltage	Output Current					
			U Channel Convection	U Channel with 300 LFM	Slotted Cover Convection	Slotted Cover with 300 LFM	Solid Cover Convection	Solid Cover with 300 LFM
MVPS800-1Q12	180-400W	12V	25A	33.33A	17.5A	31.25A	15A	31.25A
MVPS800-1Q15	225-500W	15V	25A	33.33A	17.5A	31.25A	15A	31.25A
MVPS800-1Q24	360-800W	24V	25A	33.33A	17.5A	31.25A	15A	31.25A
MVPS800-1Q30	360-800W	30V	20A	26.66A	14A	25A	12A	25A
MVPS800-1Q48	360-800W	48V	12.5A	16.66A	8.75A	15.625A	7.5A	15.625A
MVPS800-1Q58	360-800W	58V	10.34A	13.78A	7.25A	12.93A	6.2A	12.93A

Notes

1. For slotted cover change **Q** above for **S**, for solid cover version change **Q** above for **I**
2. Combined output power is main DC output + fan output 12V / 500mA max
3. 1000W overload for 500mS for 30V 48V and 58V only, not field configurable.

Key specifications

Parameter	Minimum	Typical	Maximum	Units	Notes & Conditions
AC Input range	85		264	VAC	Derate from 100% at 120VAC to 70% at 85VAC
Operating temperature	-40		70	°C	See derating curve p3.
Efficiency	120VAC 88% and 240VAC 93% typical				
Dimensions	5 x 8.5 x 1.61" (127 x 216 x 40.9mm)				
EMC	EN55011 Level B conducted and radiated with king core K5B RC 25x12x15-M on input. EN61000-3 and EN61000-4, harmonics, flicker, Surge, EFT, ESD, conducted and radiated immunity IEC 60601-1-2 4th Ed				
Safety	EN60601-1, IEC6061-1 (ed3), ANSI/AMMI ES 60601-1, CSA C22.2 No 60601-1				

MVPS800 Series

Input

Parameter	Minimum	Typical	Maximum	Units	Notes & Conditions
Input voltage	85		264	VAC	Derate from 100% at 120VAC to 70% at 85VAC
Input frequency	47		63	Hz	
Power factor	0.95		0.98		EN61000-3-2 class D compliant, at full load. 0.98 at 120VAC and 0.95 at 240VAC
Input current (rms)			8	A	At 120VAC
			3.64		At 240VAC
Inrush current			25	A	230VAC cold start at 25°C
No load input power	3W		6W	W	3W output disabled 6W output enabled

Output

Parameter	Minimum	Typical	Maximum	Units	Notes & Conditions
Output voltage	12		58	VDC	See Model & Ratings table
Output voltage Adjust		±3		%	
Set point accuracy			±1	%	
Line regulation			±0.5	%	
Load regulation			±1	%	
Minimum load	0			%	
Transient response			10	%	50-100% step change 0.1A/uS slew 50% duty 50hz in <5ms
Ripple & Noise		2		%	All models measured with 0.1uF ceramic and 10uF electrolytic capacitor. 20 MHz bandwidth. At rated line and 25W min load.
Hold up time	8			mS	
Overload protection		110		%	Hiccup mode, Auto recovery
Short circuit protection					Latch reset
Overvoltage protection		114		%	Latch reset
Over temperature protection	130		140	°C	Measured at primary heatsink. Auto recovery
Leakage current			400	uA	240VAC / 50Hz
Touch current			100	uA	

General

Parameter	Minimum	Typical	Maximum	Units	Notes & Conditions
Efficiency	120VAC 88% and 240VAC 93% typical				
Isolation: Input to Output	4245			VAC	
Input to Ground	1625			VAC	
Output to ground	1500			VAC	
Switching frequency	85		100	kHz	100 kHz variable for power switching. Variable PFC switching 85kHz
Power density			11.69	W/In ³	
MTBF	>1.28			MHrs	As per Telcordia-SR332- issue 3
Weight		1100		g	

Environmental

Parameter	Minimum	Typical	Maximum	Units	Notes & Conditions
Operating temperature	-40		70	°C	Please see derating curve on page 3
Storage temperature	-40		85	°C	
Cooling					Natural convection
Altitude	4876		12192	m	4876m operating 12192m non operating
Humidity	5		95	% RH	Non condensing

Power Derating Curve 12V

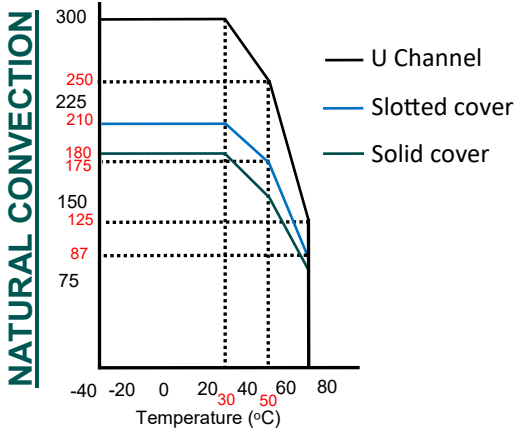

Power Derating Curve 15V

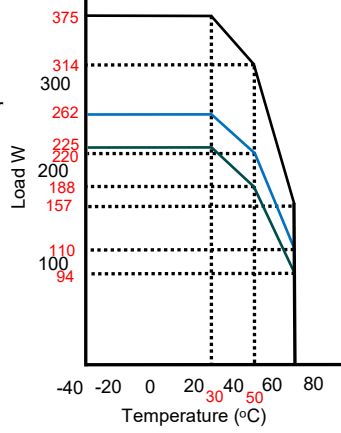

Power Derating Curve Others

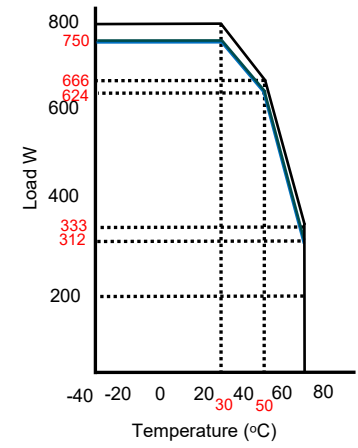
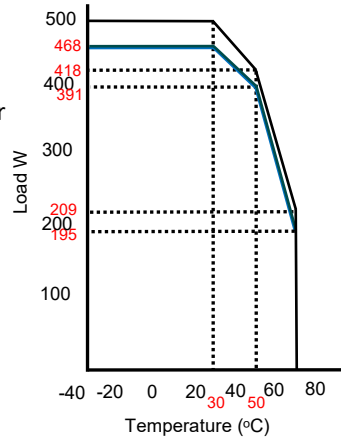
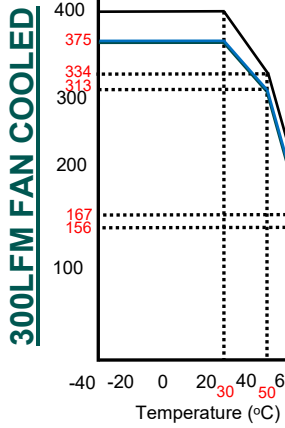
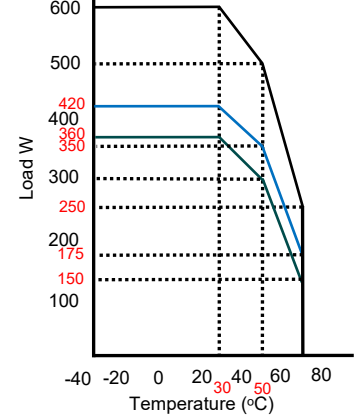

EMC: Emissions

	Standard	Test level	Criteria	Notes & Conditions
Conducted	EN55011	B		CISPR22-B, FCC PART15-B also
Radiated	EN55011	B		With ferrite king core K5B RC 25x12x15-M on input
Harmonic current	EN61000-3-2	Class A		
Voltage flicker	EN61000-3-3			

EMC: Immunity

	Standard	Test level	Criteria	Notes & Conditions
ESD	EN61000-4-2	4	A	±8kV contact, ±15kV air.
Radiated	EN61000-4-3	3	A	10V/m 80MHz-2.7GHz sine wave 80% AM 1kHz
EFT	EN61000-4-4	3	A	2kV Power, 1kV I/O 5kHz
Surges	EN61000-4-5	Installation Class 3	A	1kV Live-Neutral, 2kV Live/Neutral—Earth
Conducted	EN61000-4-6	3	A	10V, 0.15 to 80MHz sine wave 80AM 1kHz
Magnetic Fields	EN61000-4-8	4		30A/M
Voltage Dips / Interruptions	EN61000-4-11			100% for 0.5 & 1 cycle, 30% for 25 cycles: B,B,B interrupt 250,300 cycles and 30% for 30 cycles: B,B,B

AC Power Derating Curve

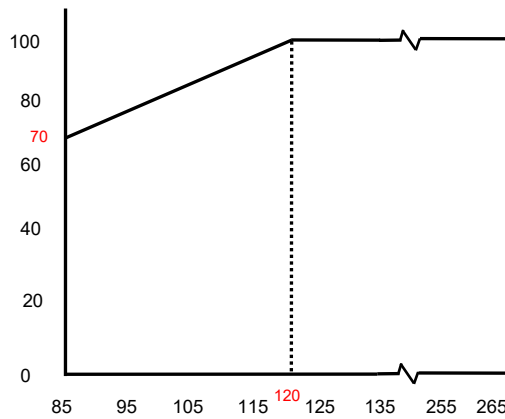

Application notes

Signals

Power Good: TTL output activated at 90% of Vout. Delay between 100 and 500mS

At least 1mS before Vout falls below 90% TTL signal switches low

Remote Sense: Compensation for 200mV voltage drop on cable runs

Remote on/off: Unit comes pre-configured with pin 6 & 7 shorted to enable the unit

Current limit: Do not remove. This feature is not field configurable.

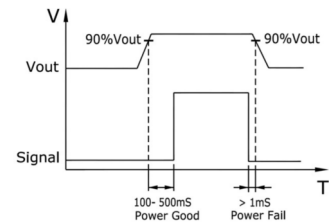

Load share

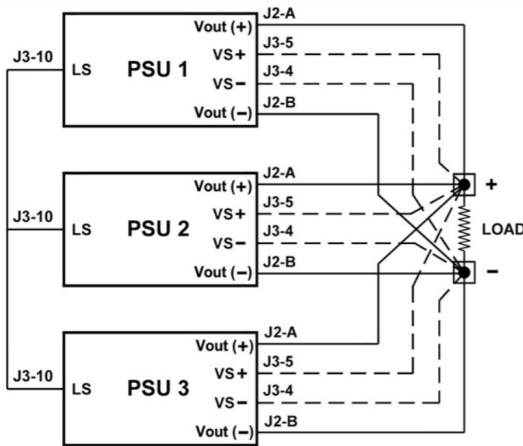

The volt sense lines must all be connected to one point and the output voltage of each the power supplies must be adjusted to be within 1% for the current share to operate. Should they not be adjusted the current share will not function. When using the load share function derate the cumulative power total by 10%. Please follow the below step by step process to ensure smooth operation:

- Connect all output cables to Vout
- Connect all Vs cables and twist pairs together
- Terminate all the Vs lines to the same +/- points
- Connect the load share (LS pin 10 on J3) of all the units
- With other units tuned off, on each PSU use the output adjust to change Vout within 1%
- The current share should be checked with a DC hall sensor showing that the power supplies share the current within 10%

Safety Approvals

	Safety standard	Notes & Conditions
UL/CSA	ANSI/AMMI ES 60601-1, CSA C22-2 NO- 60601-1	UL Certificate No : 20190221-E173812
CB	IEC60601-1 3rd ed	CB Test Certificate No : NO105338
Nemko	EN60601-1 3rd ed	Nemko Certificate No : P19223365
CE		2015/863/EU RoHS Directive and 2014/35/EU Low voltage directive
Equipment protection class		Class I

Mechanical Details

U Channel

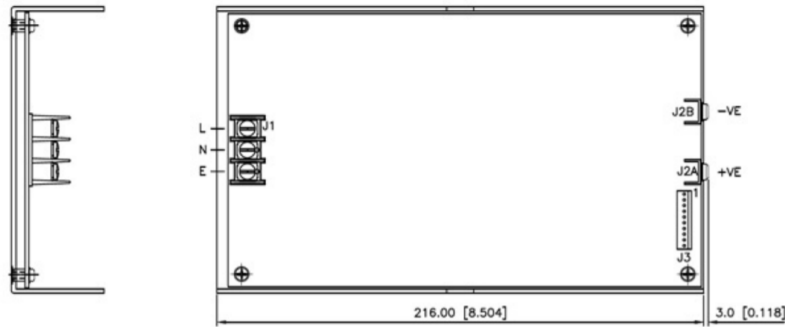

J1: Input Connector ⁽²⁾	
Pin Connections	
Pin	Function
1	Line
2	Neutral
3	Earth

Slotted cover

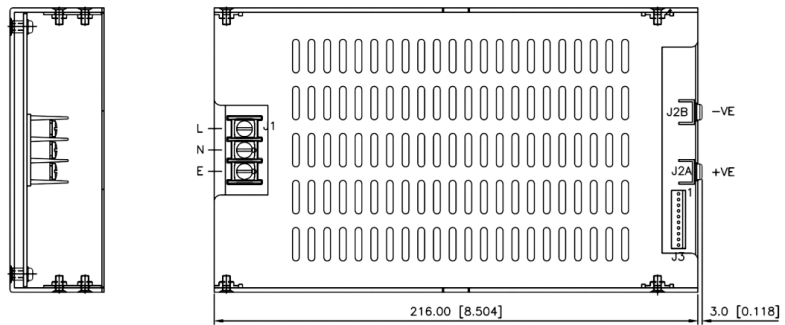

J2: Output Connector ⁽³⁾	
Pin Connections	
Pin	Function
J2A	+Vout
J2B	-Vout

Solid cover

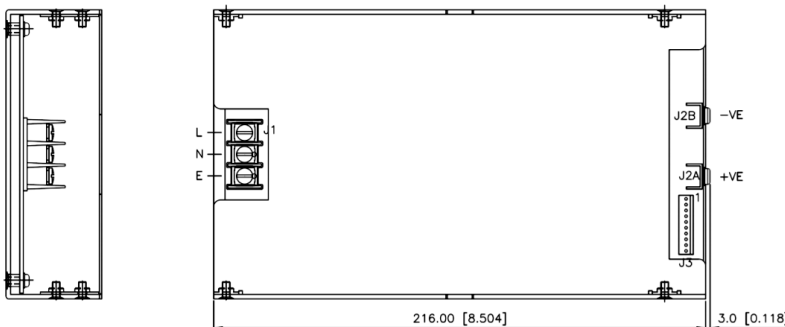

J3: I/O Connector ⁽⁴⁾	
Pin Connections	
Pin	Function
1	GND
2	+5V 1.5A
3	PGPF
4	VS-
5	VS+
6	GND
7	Remote on/off
8	Current limit p2
9	Current limit p1
10	Load share

Side view



Bottom view

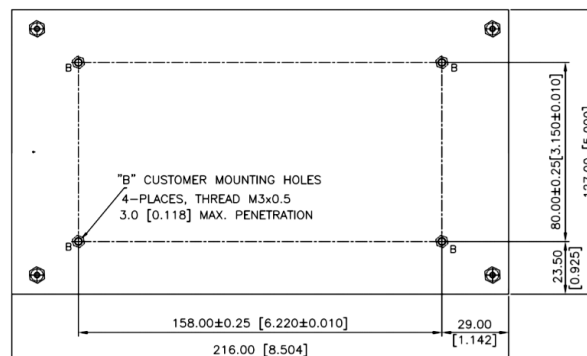

Notes

- All dimensions shown in mm [inches]
- J1: Input connector: TE Connectivity: NC6-P107-03
- J2: Output connector: 6-32 pan screw. Can accept AMP 8-31886-1 Tongue (11A max AWG16)
- J3: I/O header Molex: 22-23-2101 mating part Molex: 22-01-2107

Installation Advice

Safety

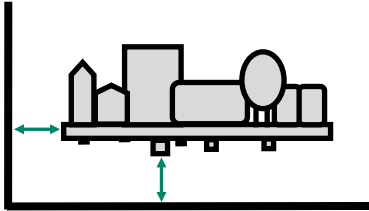

On installation customers must consider the required creepage and clearance distances between the PSU and the end-equipment enclosure. These distances vary depending on the installation class and safety standard requirements.

For **Class I** installations there should be 3-4mm between any part of the PSU and any earthed metal part of the enclosure. 3mm is acceptable for IT applications, 4mm required for medical applications. In Class I installations the PSU earth point must be connected to system safety ground.

For **Class II** installations distances may need to be increased if being installed into a surrounding metal enclosure.

Ensure consideration of components on the underside of the PCB or low lying spills when measuring clearance distances between the PSU and the end-equipment. Also top surface especially in tight enclosures such as 1U boxes. An insulation material can be used between PSU and metal if smaller gap required.

FiDUS recommends installing the PSU on 6mm stand offs typically, but check the distances.

EMC

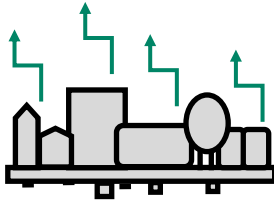

Conducted and radiated emissions compliance is a common application consideration. It is important to remember that even when using a properly filtered PSU, an application may still not achieve compliance if it is not designed to minimise emissions. That being said, there are a number of things that can be done to optimise EMC performance either as best practice, or if you are struggling for compliance:

- 1) Connect all marked EMI ground points to earth. Often these are combined with the safety earth point (in class I installations), but on some power supplies there may be additional earth tags or mounting points.
- 2) Minimise the length of input/output wiring where possible and try to maintain max distance of the conductors from the PSU, to prevent noise pick up. Avoid bundling input and output cables together. A common component to avoid placing wiring near is the PFC inductor in power factor corrected power supplies.
- 3) Apply additional filtering before the PSU input (ensure consideration of which frequencies there are issues with before selecting a filter).
- 4) When using an open frame PSU, mount the supply on a metal plate and connect EMI mounting points.
- 5) In multi circuit systems, decouple the circuits locally.
- 6) Ferrites added between the PSU and system input connector and/or the DC output cables can help in reducing radiated noise issues in systems. If seen, issues are commonly in the 30-150MHz area.

For more detailed assistance, if you still have any concerns with compliance, please get in contact with our Engineering department who are on hand to assist with any queries.

Thermal

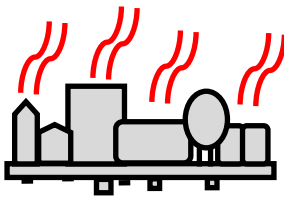

Thermal management is an important consideration when thinking about equipment service life. Electrolytic capacitors within the PSU wear with time and are typically the first end-of-life failure. Keeping the operation temperature of key components within the PSU, such as the electrolytic capacitors, as low as possible is paramount. As a general rule, for every 10°C drop in the operating temperature of the electrolytic capacitors you double their lifetime, and thus the lifetime of the power supply. When looking at thermal performance it is helpful to test under a worst-case set of conditions, to ensure component temperatures are in an acceptable range for the required service life. Then consider the impact of operational time, load and temperature profile to estimate a more realistic lifetime for your PSU.

Also, many FiDUS power supplies offer a *Peak Power* rating to provide for customers with pulsing loads. When using a peak power capability customers must consider:

- 1) Peak duration rating: the maximum length of time the peak can be drawn for
- 2) Duty cycle: the frequency with which the peak can be drawn. (e.g. 10% duty cycle, 1 second on:9 seconds off)
- 3) Average power value: datasheets will state the maximum average power acceptable with peak power PSUs. If any of these elements are exceeded the supply may overheat, with performance and lifetime suffering as a result.