

NEVO+1200S Series

1200 Watts

- 6" x 6" x 1.61" package (suitable for 1U enclosure)
- IEC/EN/UL 62368-1 Approval
- Modular (factory and user configurable)
- Constant current or voltage operation
- Remote current and voltage programming
- Parallel and series configuration of modules
- 3 Year warranty



Dimensions:

6" x 6" x 1.61"

The compact NEVO+1200S IT and industrial power supply delivers an impressive 1200W configurable power of 8 x 150W isolated modules that fit neatly in a 1U enclosure. The unit is impressively featured with analogue current and voltage programming, analogue current output signal, 2 x 5V 1A bias supply, global / local inhibit, AC OK and DC OK power good signals. The NEVO+1200S allows accurate current sharing across multiple modules to handle the most demanding applications where a large current is required, also the unit can be configured in series to support applications requiring high voltages. The units utilise an integrated fan (low noise option for sound sensitive applications) which gives it thermal versatility for orientation flexibility to best suit your design.

APPLICATIONS

- Test and measurement
- Robotics
- Oil and gas
- High vibration and shock
- Telecommunications
- Display applications
- Avionics
- Laboratory & analysis equipment
- Laser power
- LED lighting
- Retrofit of legacy PSUs
- 1U enclosure applications

Part Numbering

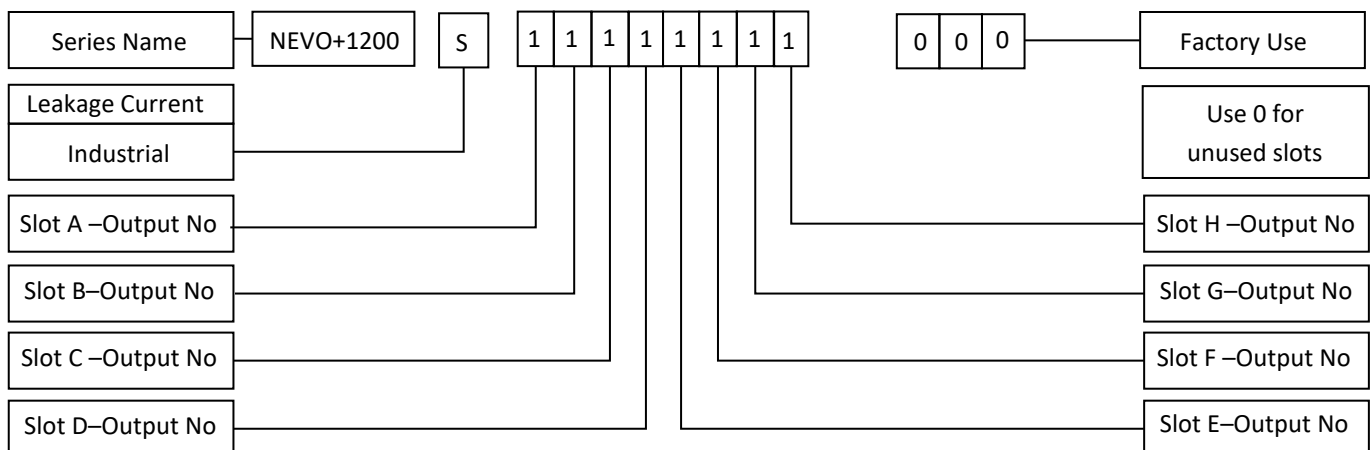

Select modules from module summary table on page 2. The NEVO+1200 can be configured with 1-8 output modules which can be configured in parallel for higher currents, in series for higher voltages or a combination of both to suit your application. Contact sales to discuss your requirements

NEVO+1200S Series

Output Module Summary

Model	Output Voltage			Output Current	Rated Power	Peak Power ⁽¹⁾	Load Reg.	Line Reg	Cross Reg.	Ripple & Noise	FPMH ⁽²⁾	Feature Set ⁽³⁾
	Min	Nom	Max									
OP1	1.5V	5V	7.5V	25A	125W	187.5W	±50mV	±5mV	±10mV	50mVpk-pk	1	ABCDE
OP2	4.5V	12V	15V	15A	150W	225W	±100mV	±12mV	±24mV	120mVpk-pk	1	ABCDE
OPA2	4.5V	12V	15V	25A	300W	375W	±100mV	±0.1%Vnom	±0.2%Vnom	1%Vnom	1	ABCDE
OP3	9V	24V	30V	7.5A	150W	225W	±150mV	±24mV	±48mV	240mVpk-pk	1	ABCDE
OPA3	9V	24V	30V	15A	300W	450W	±150mV	±0.1%Vnom	±0.2%Vnom	1%Vnom	1	ABCDE
OP4	18V	48V	58V	3.75A	150W	225W	±300mV	±48mV	±96mV	480mVpk-pk	1	ABCDE
OP5 ⁽⁴⁾	3.3V	12V	15V	5A ea	2 x 75W	-	±50mV	±12mV	±24mV	2% Vset	1	AF

Notes

1. Peak power is available when output voltage is adjusted above Vnom. Please see option card datasheet for details
2. 40°C ambient, 80% Load
3. A = Remote Sense B = External voltage control C = External current control D = Current output signal E = Current share F = Dual output
4. OP5 Dual outputs have two independently adjustable outputs across the stated ranges above
5. Please view option card data sheets for details

Input Module Specifications

Parameter	Minimum	Typical	Maximum	Units	Notes & Conditions
Input voltage	85		264	VAC	Nominal is 100V-240V RMS. Derate from 120VAC by 10W/V to 85VAC
	120		370	VDC	
Input frequency	47		63	Hz	For 400Hz please contact sales
Power factor		0.99			Typical value for 300W at 240Vrms input
Input current			12	A	1200W output 120Vrms input
Input current limit		14		A	
Inrush current			40	A	264Vrms 25°C (cold start)
Input protection			12.5	A	Both lines fused 5x20 fast fuses
No load input power	32		46	W	32W disabled outputs, 46W enabled outputs
Standby Power		2.5		W	Latched off state 120Vrms
Efficiency		86	89	%	See graphs for details
Holdup	17	20	21	mS	1200W at 120Vrms input
UVLO	78		84	VRMS	Turn on under voltage
Overtemperature protection	115		125	°C	Latching
Reliability			2	FPMH	40°C 80% Load
Size	6 (154.5) x 6 (152.4) x 1.61 (41)			Inches (mm)	LxWxH ±1mm
Weight		720+60/module		g	
Isolation voltages			4000	VAC	Input to output
			1500	VAC	Input to chassis
			250	VDC	Output to chassis
			250	VDC	Output to output
Isolation clearance	7			mm	Primary—secondary (reinforced)
	2.5			mm	Primary—chassis (basic)
Isolation creepage	12			mm	Primary—secondary (reinforced)
	4			mm	Primary—chassis (basic)
Leakage current			1500	uA	Normal condition, 264VAC, 63Hz, 25°C

Signal Specifications

Parameter	Minimum	Typical	Maximum	Units	Notes & Conditions
Bias voltage	4.8	5	5.2	V	2 x isolated
Bias current	0		1	A	Hiccup current limit. 0.5A max for primary bias
AC_OK Voltage	4.7/0		5.2/0.1	V	High output level / Low output level
AC_OK Current	-10		10	mA	
AC_OK warning	5			ms	See user manual
Power good voltage	8	10	15	V	PNP open collector output, 10K Ω pull down resistor
Power good current	0		20	mA	
Inhibit voltage	2		15	V	
Inhibit current	0.2		1.5	mA	10k Ω input impedance.
Global inhibit voltage	3		15	V	
Global inhibit current	0.6		3	mA	5k Ω input impedance
Primary Remote On/Off voltage		5		V	Negative edge triggered. See user manual

Environmental

Parameter	Minimum	Typical	Maximum	Units	Notes & Conditions
Operating temperature	-20		70	$^{\circ}$ C	See p4 for derating curve
Storage temperature	-40		85	$^{\circ}$ C	
Operating humidity	5		95	%RH	Non condensing
Storage humidity	5		95	%RH	Non condensing
Operating air pressure	78		106	kPa	
Storage air pressure	54		106	kPa	
Operating altitude	-200		3000	M	
Non-operating altitude	-200		5000	M	
Fan noise	42		61	dBA	1m from fan intake –Low noise fans available
Operating shock	3000 bumps at 10G (16ms) half sine wave				
Vibration	1.5G to 200Hz sine wave, 20G for 15min in 3 axes random vibration				

Installation Specifications

Parameter	Details	Parameter	Details
Equipment class	I	Flammability rating	94V-2
Installation category	II	Ingress protection	IP10
Material group	IIIb (indoor use only)	ROHS3 compliance	2011/65/EU + 2015/863/EU
Pollution degree	2	Intended usage environment	Industrial equipment

Safety Approvals

	Safety standard	Notes & Conditions
UL	UL62368-1 CAN/CSA-22.2 No. 62368-1	UL file E316486
CB	IEC 62368-1: 2014	
EU	EN 62368-1: 2014	
CE		2014/30/EU EMC directive, 2014/35/EU Low voltage directive

NEVO+1200S Series

EMC: Emissions

	Standard	Test level	Notes & Conditions
Conducted	EN55022/11	B	FCC part 15, CISPR 22/11
Radiated	EN55022/11	A	
Harmonic current	EN61000-3-2	Class A	
Voltage flicker	EN61000-3-3		

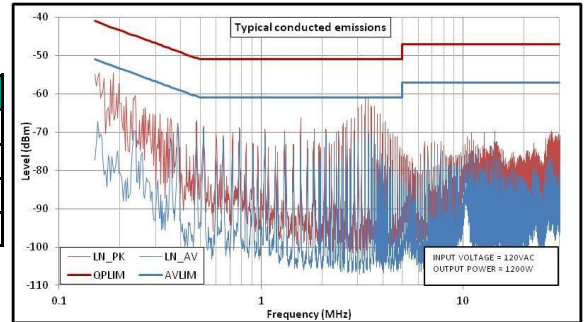

EMC: Immunity

	Standard	Test level	Criteria	Notes & Conditions
ESD	EN61000-4-2	4	A	15kV Air, 8kV Contact
Radiated	EN61000-4-3	3	A	10V/m 80MHz-2.7GHz sine wave 80% AM 1kHz
EFT	EN61000-4-4	3	A	2kV Power, 1kV I/O
Surges	EN61000-4-5	Installation Class 3	A	1kV Live-Neutral, 2kV Live/Neutral—Earth
Conducted	EN61000-4-6	4	A	10V, 0.15 to 80MHz sine wave 80AM 1kHz
PFMF	EN61000-4-8	3	A	10A/m 50Hz
Voltage dips	EN61000-4-11	95% 0.5 & 1 cycle A, 30% 25 cycles A (240/100VAC), 60% 10 cycles A/C (240/100VAC)		
Voltage Interruptions	EN61000-4-11	>95% interruption 250 cycles C (IEC60601-1-1-2: 2014)		

Power Derating Curve

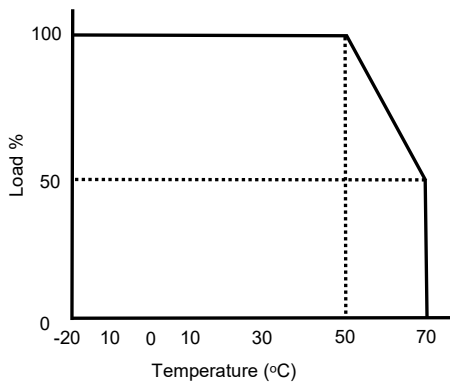

AC Input Derating Curve

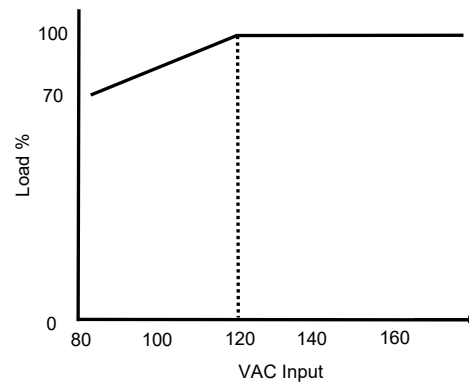

Efficiency

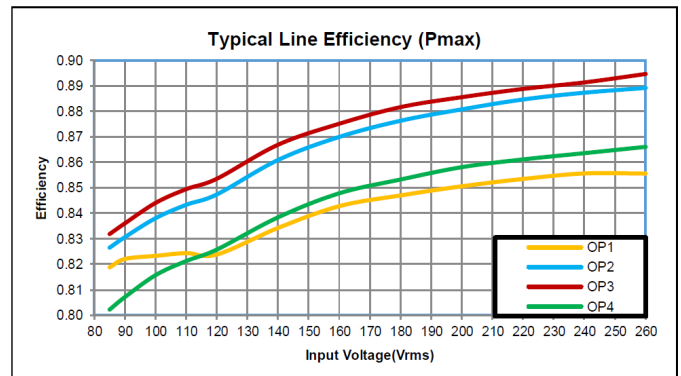
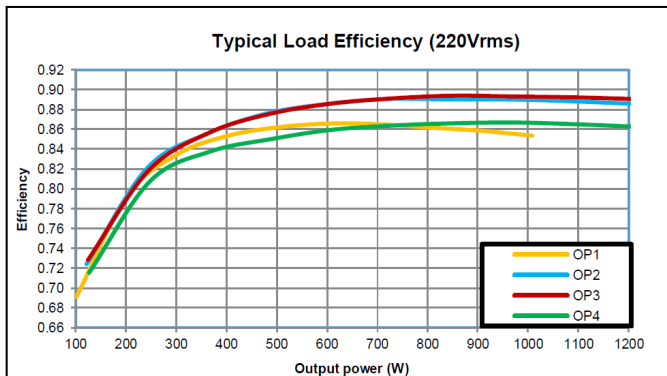

Mechanical Details

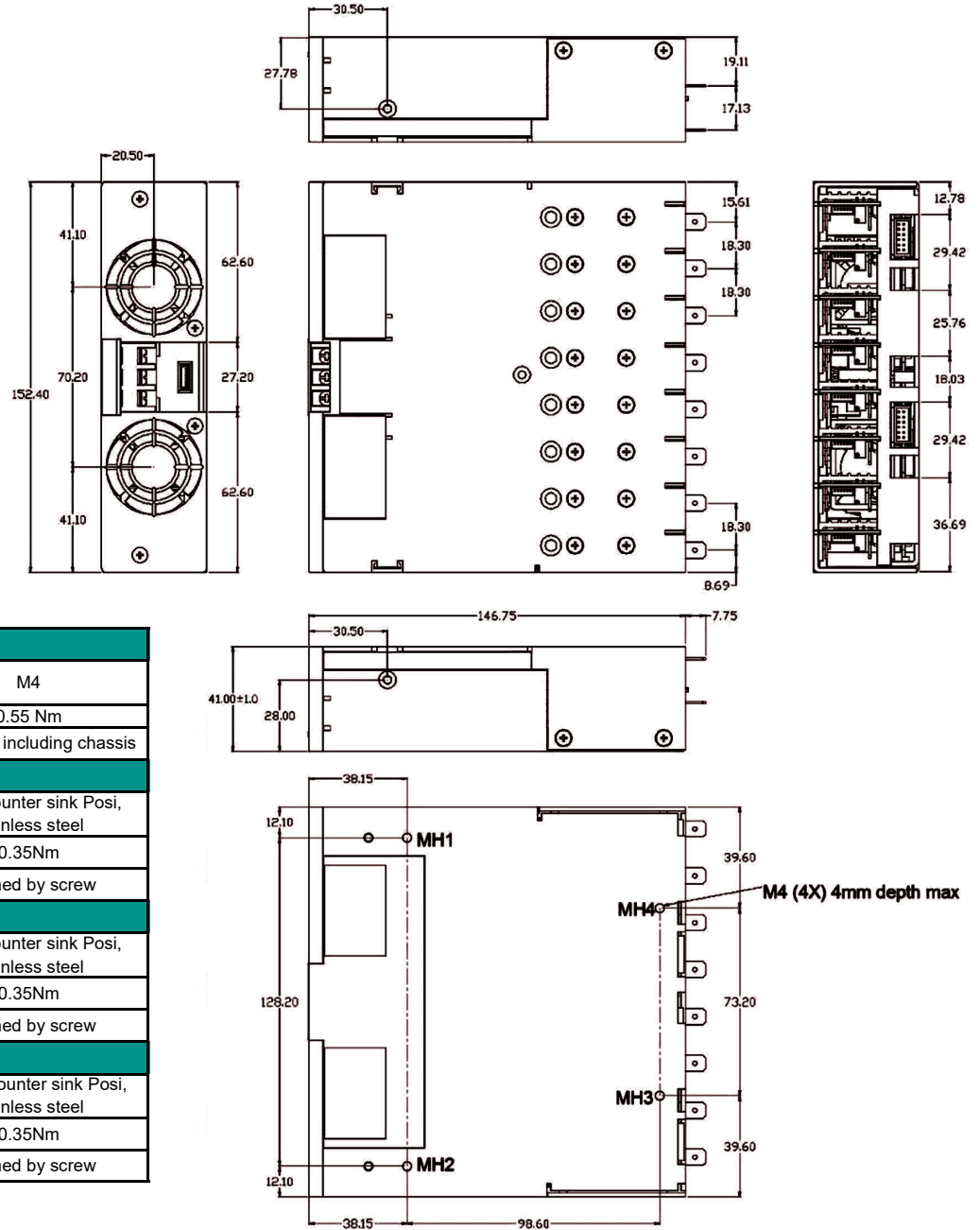

Screws

MH1, MH2, MH3, MH4, and MH5

Screw type	M4
Torque	0.55 Nm
Thread depth	4mm max including chassis

Output modules x 16

Screw type	M3x5 counter sink Posi, stainless steel
Torque	0.35Nm
Thread depth	Defined by screw

Chassis x 11

Screw type	M3x5 counter sink Posi, stainless steel
Torque	0.35Nm
Thread depth	Defined by screw

Fan x 4

Screw type	M3x30 counter sink Posi, stainless steel
Torque	0.35Nm
Thread depth	Defined by screw

Notes

1. Torque settings are for general reference only. The torque settings shown are the inset manufacturers recommended values

Connector Details

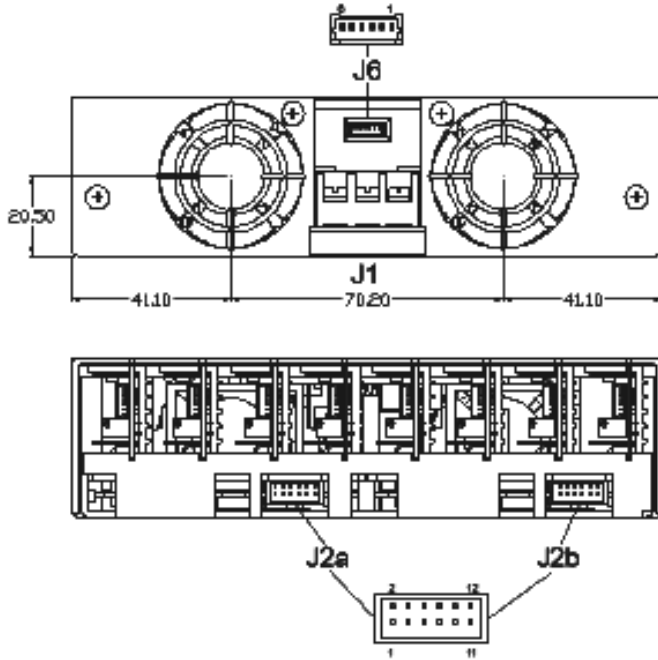

**Pin Connections (J1)
Mains input⁽¹⁾**

Pin	Function
1	Live
2	Earth
3	Neutral

Pin Connections (J2a/b)⁽²⁾

Pin	Function	Slot
1	Power good	Slot A/E
2	Inhibit	
3	Power good	Slot B/F
4	Inhibit	
5	Power good	Slot C/G
6	Inhibit	
7	Power good	Slot D/H
8	Inhibit	
9	Global inhibit	
10	AC OK	
11	+5V Bias supply 1A	
12	COM	

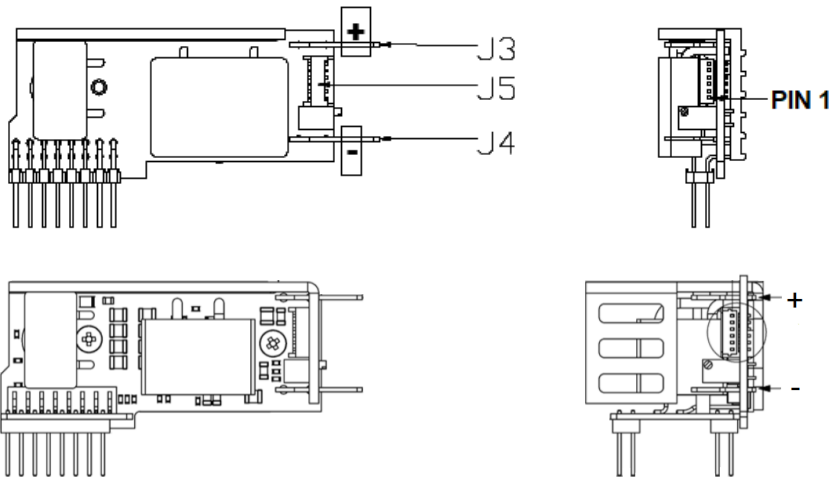

**Pin Connections (J6)
Output signals OP1-4⁽⁵⁾**

Pin	Function
1	Common
2	+5V 500mA Bias
3	Shut down
4	Reserved
5	Reserved
6	Reserved

**Pin Connections (J5)
Output signals OP1-4⁽⁴⁾**

Pin	Function
1	- Sense
2	+Sense
3	V Control
4	I Control / mon / share
5	COM
6	+5V Bias supply 10mA max

Notes

- J1 mating housing molex 10013036 with 0008701031 pins (18-24 AWG)
- J2 mating housing molex 511101251 with 05003948051 pins (24-30 AWG)
- J3/4 tabs 6.35 x 0.8mm
- J5 mating housing 0510210600 with 0500588000 pins (28-32 AWG)
- J6 mating housing 510210600, 500588000 pins (28-32 AWG)
- All cables must be 105°C min, equivalent to UL1015
- All dimensions in mm

Nevo+600 Series module 1: 1.5-7.5V 125W

125 Watts

- Peak power 187.5W (<5 sec 50 duty cycle)
- Remote current and voltage programming
- Current share in parallel operation
- Remote sense
- 5 Year warranty

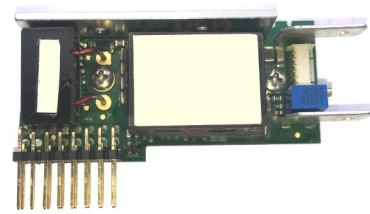

Parameter	Min	Typical	Max	Units	Notes & Conditions
Output voltage range	1.5	5	7.5	V	Manual adjustment
Output current rating			25	A	
Output power rating			125	W	
Peak power rating			187.5	W	Max 5 seconds 50% duty cycle
Initial voltage setting accuracy	-0.5		0.5	%	Factory set units
Manual voltage adjust		0.545		V/turn	11 turn potentiometer
Load regulation	-50		50	mV	Measured at sense terminals
Line regulation	-0.1		0.1	% Vnom	Measured at sense terminals
Cross regulation	-0.2		0.2	% Vnom	Measured at sense terminals
Minimum Load	0			W	
Temperature coefficient	-0.02		+0.02	% /°C	
Noise and ripple			1	% Vnom	20MHz bandwidth pk-pk
Transient response			1	V	25%-75% load change at 0.25A/us recovery within 10% in 100uS
Turn on rise time	1.5		3.5	mS	Monotonic 10%-90%
Turn on overshoot			0.1	% Vset	
Turn on delay		600	750	mS	AC-Power good
		15	20	mS	Enable to power good
Current share accuracy			5	%	
Open sense offset			2	% Vnom	Open sense, voltage offset due to bias currents
Holdup voltage			6	V	
Isolation to ground			250	V	Each output terminal
Overcurrent protection	105		125	%Inom	
Reverse current protection	-6		0	%Inom	
Short circuit protection		125/3/1		mS/%V	Period/Duty cycle/Voltage Threshold (Measured at sense terminals)
Overvoltage protection		9.5		V	Latching
Over temperature protection	115		125	°C	Internally monitored, latching
Sense cable protection	-1		2	V	Positive
			1	V	Negative
Power good threshold		90		% Vset	Low threshold only
Current output signal	0		110	%Inom	$I_{sig} = 0.6 + I_{out} / (I_{nom} * 1.25)$
Current limit control	0		110	%Inom	$I_{limit} = (V_{ctrl} - 0.6) * I_{nom} * 1.25$
Remote voltage control	0		300	% Vset	$V_{out} = V_{set} * ((1.8 - V_{ctrl}) / 0.6)$
Bias supply	4.5	5	5.2	V	10mA max
Reliability			1	FPMH	40°C 80% load
Size		60 x 35 x 17		mm	LxWxH
weight		60		g	
Wire size	12	10		AWG	

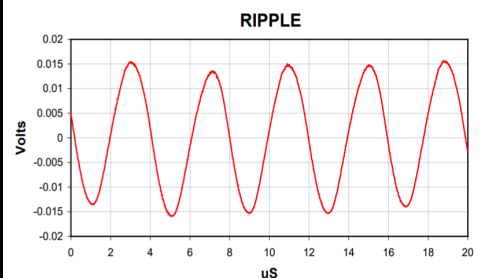
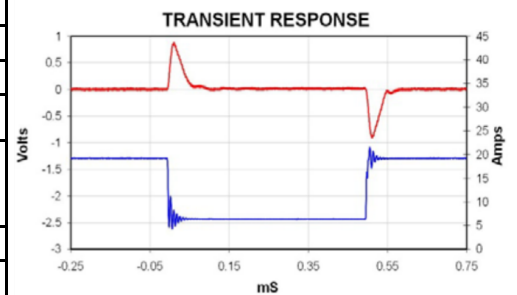
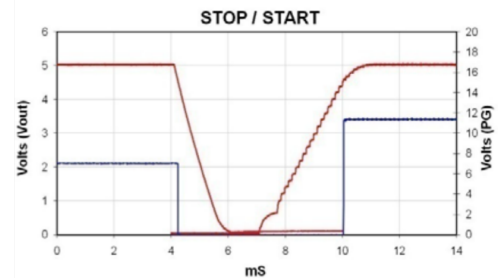
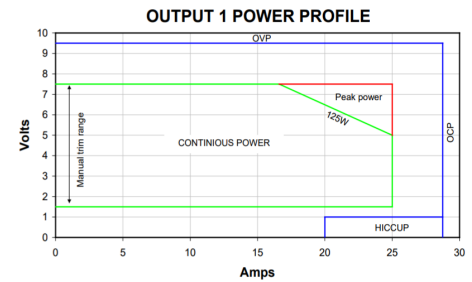

Nevo+600 Series module 2: 4.5-15V 150W

150 Watts

- Peak power 225W (<5 sec 50 duty cycle)
- Remote current and voltage programming
- Current share in parallel operation
- Remote sense
- 5 Year warranty

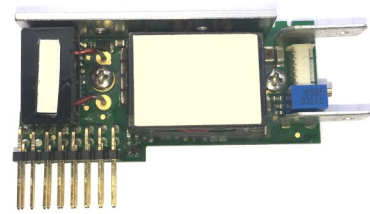

Parameter	Min	Typical	Max	Units	Notes & Conditions
Output voltage range	4.5	12	15	V	Manual adjustment
Output current rating			15	A	
Output power rating			150	W	
Peak power rating			225	W	Max 5 seconds 50% duty cycle
Initial voltage setting accuracy	-0.5		0.5	%	Factory set units
Manual voltage adjust		0.954		V/turn	11 turn potentiometer
Load regulation	-100		100	mV	Measured at sense terminals
Line regulation	-0.1		0.1	% Vnom	Measured at sense terminals
Cross regulation	-0.2		0.2	% Vnom	Measured at sense terminals
Minimum Load	0			W	
Temperature coefficient	-0.02		+0.02	% /°C	
Noise and ripple			1	% Vnom	20MHz bandwidth pk-pk
Transient response			1.5	V	25%-75% load change at 0.25A/us recovery within 10% in 100uS
Turn on rise time	1.5		3.5	mS	Monotonic 10%-90%
Turn on overshoot			0.1	% Vset	
Turn on delay		600	750	mS	AC-Power good
		15	20	mS	Enable to power good
Current share accuracy			5	%	
Open sense offset			2	% Vnom	Open sense, voltage offset due to bias currents
Holdup voltage			12.5	V	
Isolation to ground			250	V	Each output terminal
Overcurrent protection	105		125	%Inom	
Reverse current protection	-6		0	%Inom	
Short circuit protection		125/3/2		mS/%V	Period/Duty cycle/Voltage Threshold (Measured at sense terminals)
Overvoltage protection		18		V	Latching
Over temperature protection	115		125	°C	Internally monitored, latching
Sense cable protection	-1		2	V	Positive
			1	V	Negative
Power good threshold		90		% Vset	Low threshold only
Current output signal	0		110	%Inom	$I_{sig} = 0.6 \cdot I_{out} / (I_{nom} \cdot 1.25)$
Current limit control	0		110	%Inom	$I_{limit} = (V_{ctrl} - 0.6) \cdot I_{nom} \cdot 1.25$
Remote voltage control	0		300	% Vset	$V_{out} = V_{set} \cdot ((1.8 - V_{ctrl}) / 0.6)$
Bias supply	4.5	5	5.2	V	10mA max
Reliability			1	FPMH	40°C 80% load
Size		60 x 35 x 17		mm	LxWxH
weight		60		g	
Wire size	16	14	10	AWG	

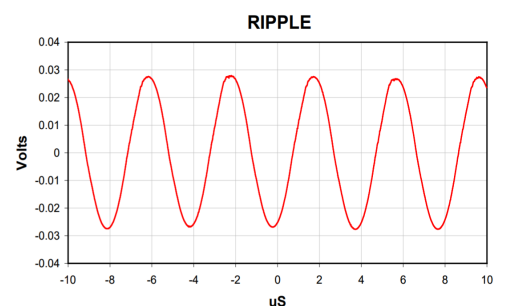
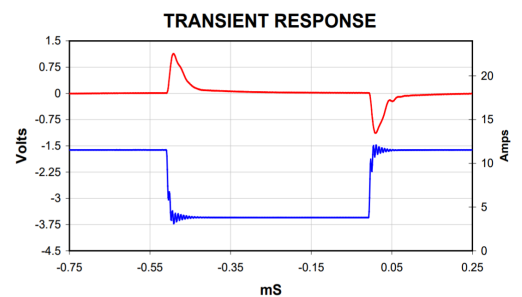
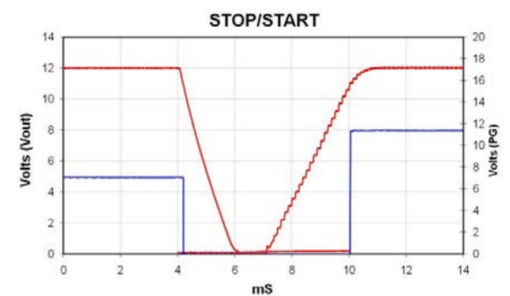
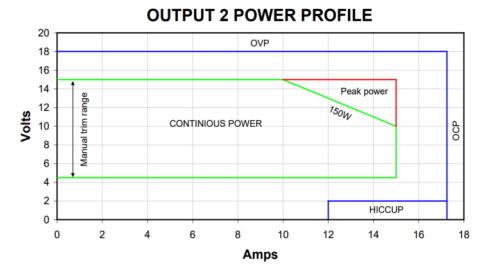

Nevo+600 Series output module 3: 9-30V 150W

150 Watts

- Peak power 225W (<5 sec 50% duty cycle)
- Remote current and voltage programming
- Current share in parallel operation
- Remote sense
- 5 Year warranty

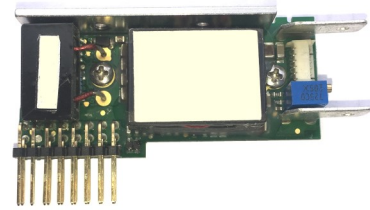

Parameter	Min	Typical	Max	Units	Notes & Conditions
Output voltage range	9	24	30	V	Manual adjustment
Output current rating			7.5	A	
Output power rating			150	W	
Peak power rating			225	W	Max 5 seconds 50% duty cycle
Initial voltage setting accuracy	-0.5		0.5	%	Factory set units
Manual voltage adjust		1.9		V/turn	11 turn potentiometer
Load regulation	-150		150	mV	Measured at sense terminals
Line regulation	-0.1		0.1	% Vnom	Measured at sense terminals
Cross regulation	-0.2		0.2	% Vnom	Measured at sense terminals
Minimum Load	0			W	
Temperature coefficient	-0.02		+0.02	% /°C	
Noise and ripple			1	% Vnom	20MHz bandwidth pk-pk
Transient response			3	V	25%-75% load change at 0.25A/ us recovery within 10% in 100uS
Turn on rise time	1.5		3.5	mS	Monotonic 10%-90%
Turn on overshoot			0.1	% Vset	
Turn on delay		600	750	mS	AC-Power good
		15	20	mS	Enable to power good
Current share accuracy			5	%	
Open sense offset			2	% Vnom	Open sense, voltage offset due to bias currents
Holdup voltage			25	V	
Isolation to ground			250	V	Each output terminal
Overcurrent protection	105		125	%Inom	
Reverse current protection	-6		0	%Inom	
Short circuit protection		125/3/3.5		mS/%V	Period/Duty cycle/Voltage Threshold (Measured at sense terminals)
Overvoltage protection		36		V	Latching
Over temperature protection	115		125	°C	Internally monitored, latching
Sense cable protection	-1		2	V	Positive
			1	V	Negative
Power good threshold		90		% Vset	Low threshold only
Current output signal	0		110	%Inom	$I_{sig} = 0.6 + I_{out} / (I_{nom} * 1.25)$
Current limit control	0		110	%Inom	$I_{limit} = (V_{ctrl} - 0.6) * I_{nom} * 1.25$
Remote voltage control	0		300	% Vset	$V_{out} = V_{set} * ((1.8 - V_{ctrl}) / 0.6)$
Bias supply	4.5	5	5.2	V	10mA max
Reliability			1		40°C 80% load
Size	60 x 35 x 17			mm	LxWxH
weight		60		g	
Wire size	20	18	10	AWG	

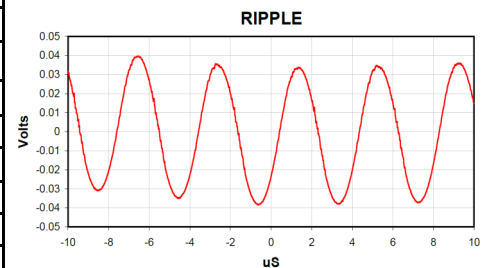
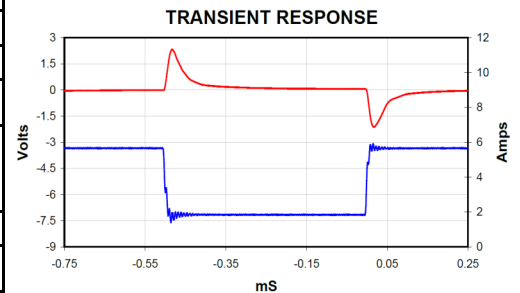
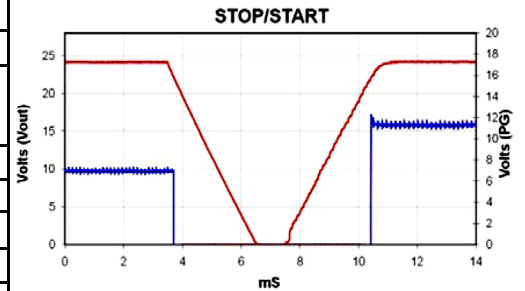
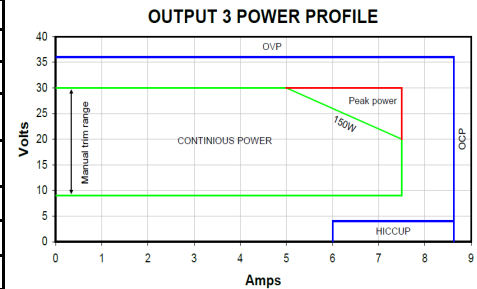

Nevo+600 Series module 4: 18-58V 150W

150 Watts

- Peak power 225W (<5 sec 50 duty cycle)
- Remote current and voltage programming
- Current share in parallel operation
- Remote sense
- 5 Year warranty

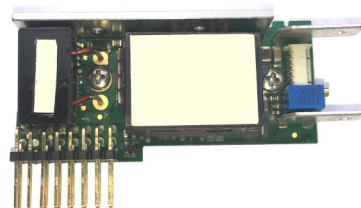

Parameter	Min	Typical	Max	Units	Notes & Conditions
Output voltage range	18	48	58	V	Manual adjustment
Output current rating			3.75	A	
Output power rating			150	W	
Peak power rating			225	W	Max 5 seconds 50% duty cycle
Initial voltage setting accuracy	-0.5		0.5	%	Factory set units
Manual voltage adjust		3.6		V/turn	11 turn potentiometer
Load regulation	-300		300	mV	Measured at sense terminals
Line regulation	-0.1		0.1	% Vnom	Measured at sense terminals
Cross regulation	-0.2		0.2	% Vnom	Measured at sense terminals
Minimum Load	0			W	
Temperature coefficient	-0.02		+0.02	% /°C	
Noise and ripple			1	% Vnom	20MHz bandwidth pk-pk
Transient response			3	V	25%-75% load change at 0.25A/us recovery within 10% in 100uS
Turn on rise time	1.5		3.5	mS	Monotonic 10%-90%
Turn on overshoot			0.1	% Vset	
Turn on delay		600	750	mS	AC-Power good
		15	20	mS	Enable to power good
Current share accuracy			5	%	
Open sense offset			2	% Vnom	Open sense, voltage offset due to bias currents
Holdup voltage			50	V	
Isolation to ground			250	V	Each output terminal
Overcurrent protection	105		125	%Inom	
Reverse current protection	-6		0	%Inom	
Short circuit protection		125/3/3.5		mS/%V	Period/Duty cycle/Voltage Threshold (Measured at sense terminals)
Overvoltage protection		66		V	Latching
Over temperature protection	115		125	°C	Internally monitored, latching
Sense cable protection	-3		3	V	Positive
			2	V	Negative
Power good threshold		90		% Vset	Low threshold only
Current output signal	0		110	%Inom	I _{sig} = 0.6 +I _{out} / (I _{nom} * 1.25)
Current limit control	0		110	%Inom	I _{limit} = (V _{ctrl} -0.6) * I _{nom} * 1.25
Remote voltage control	0		300	% Vset	V _{out} = V _{set} ((1.8-V _{ctrl}) / 0.6)
Bias supply	4.5	5	5.2	V	10mA max
Reliability			1	FPMH	40°C 80% load
Size		60 x 35 x 17		mm	LxWxH
weight		60		g	
Wire size	20	18	10	AWG	

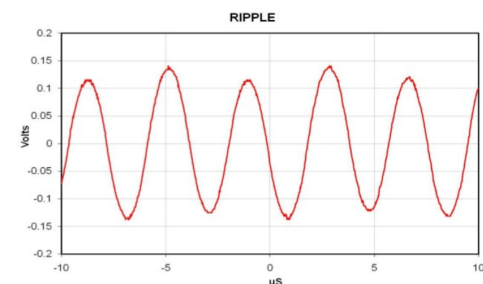
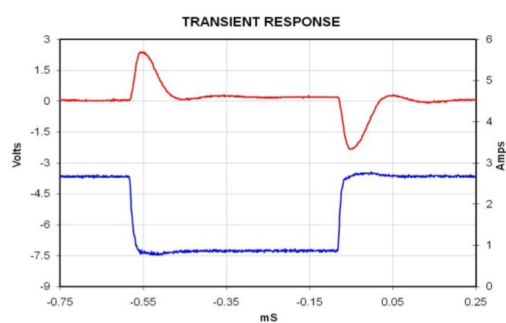
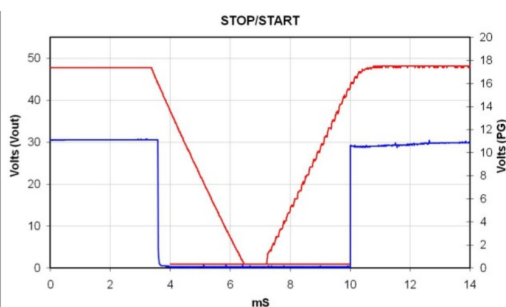
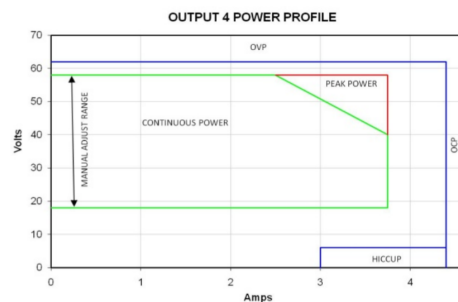

Nevo+600 Series module 5: Dual 12V 2x75W

150 Watts

- 2 x 12V independent channels
- Wide voltage range 3.3-15V
- Over current, reverse current, over voltage and short circuit protection
- 5 Year warranty

Parameter	Min	Typical	Max	Units	Notes & Conditions
Output voltage range	3.3	12	15	V	Manual adjustment. -20 to 70°C
Output current rating			5	A	Each channel
Output power rating		60	75	W	Each channel
Initial voltage accuracy	-0.5		0.5	&	
Manual voltage adjust		1.1		V/turn	11 turn potentiometer
Load regulation	-50		50	mV	Measured at sense terminals
Line regulation	-0.1		0.1	%Vnom	Measured at sense terminals
Cross regulation	-0.2		0.2	%Vnom	Measured at sense terminals
Minimum Load	0			W	
Temperature coefficient	-0.02		0.02	%/°C	
Noise and ripple			2	% Vset	20MHz bandwidth pk-pk
Transient response			1	V	25%-75% load change at 0.25A/us recovery within 10% in 100uS
Turn on rise time	2		4	mS	Monotonic 10%-90%
Turn on overshoot			1	% Vset	
Turn on delay		600	750	mS	AC-Power good
		30	40	mS	Enable to power good
Holdup voltage			12	V	
Isolation to ground			250	V	Each output terminal
Overcurrent protection	105		175	%Inom	
Short circuit protection		260/3.5/65		mS/%V	Period/Duty cycle/Voltage Threshold
Overvoltage protection		21		V	Latching
Over temperature protection	115		125	°C	Internally monitored, latching
Power good threshold		92.5		% Vset	Low threshold only
Reliability			1	FPMH	40°C 80% load Telcordia SR332
Size		60 x 35 x 17		mm	LxWxH
weight		60		g	
Wire size	20	18	10	AWG	

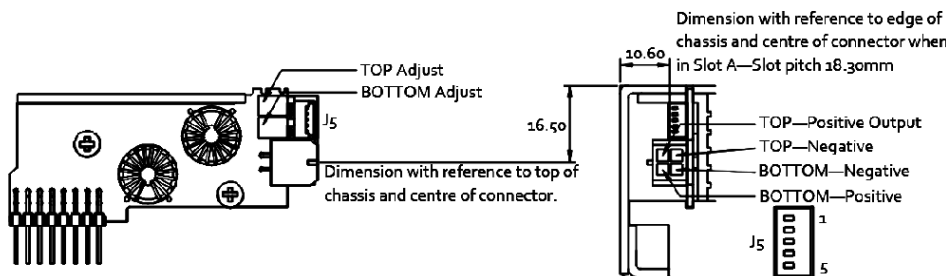
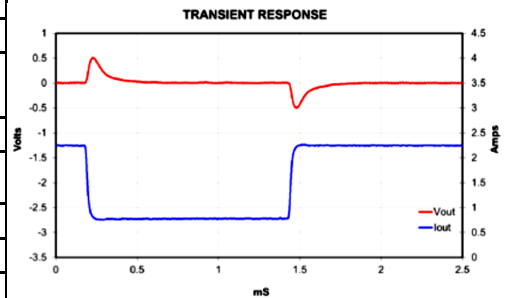
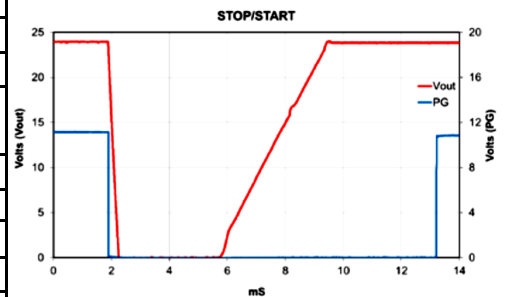
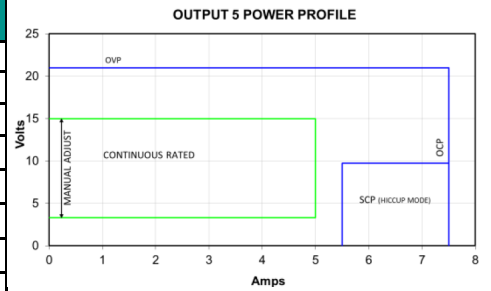

J5 Output signals ⁽¹⁾	
Pin	Function
1	Top + Sense
2	Top - Sense
3	NC
4	Bottom + Sense
5	Bottom - Sense

Notes

1. J5 mating connector molex 0510210500 with 0500588000 pins (28-32 AWG)
2. J1 mating connector molex 430250400 with 430300001 pins (20-24 AWG)

300 Watts

- Peak power 375W (5 sec)
- Remote current and voltage programming
- Current share in parallel operation
- Remote sense
- 5 Year warranty



Parameter	Min	Typical	Max	Units	Notes & Conditions
Output voltage range	4.5	12	15	V	Manual adjustment
Output current rating			25	A	
Output power rating			300	W	
Peak power rating			375	W	Max 5 seconds
Initial voltage setting accuracy	-0.5		0.5	%	Factory set units
Manual voltage adjust		0.954		V/turn	11 turn potentiometer
Load regulation	-100		100	mV	Measured at sense terminals
Line regulation	-0.1		0.1	% Vnom	Measured at sense terminals
Cross regulation	-0.2		0.2	% Vnom	Measured at sense terminals
Minimum Load	0			W	
Temperature coefficient	-0.02		+0.02	% /°C	
Noise and ripple			1	% Vnom	20MHz bandwidth pk-pk
Transient response			2 100	V us	25%-75% load transient at 0.5A/us. Recovery within 10% of Vset
Turn on rise time	1.5		3.5	ms	Monotonic 10%-90%
Turn on overshoot			0.1	% Vset	
Turn on delay		600	750	ms	AC-Power good
		15	20	ms	Enable to power good
Current share accuracy	-5		+5	%	Error from ideal sharing current. Valid for loads > 20% of rating
Open sense offset			2	% Vnom	Voltage offset between sense lines and output terminals when sense lines unused
Holdup voltage			12	V	
Isolation to ground			250	V	Each output terminal
Overcurrent protection	105	115	125	%Inom	
Reverse current protection	-6		0	%Inom	
Short circuit protection		125/3/2		ms/%V	Period/Duty cycle/Voltage Threshold (Measured at sense terminals)
Overvoltage protection		18		V	Latching
Over temperature protection	115		125	°C	Internally monitored
Sense cable protection	-1		2	V	Positive
			1	V	Negative
Power good threshold		90		% Vset	Low threshold only
Current output signal	0		125	%Rated	I _{sig} = 0.6 + I _{out} / (IRTD * 1.25)
Current limit control	0		100	%Rated	I _{limit} = (V _{ctrl} - 0.6) * IRTD * 1.25
Remote voltage control	0		131.5	% Vset	V _{out} = Vset * ((1.8 - V _{ctrl}) / 0.6)
Bias supply	4.5	5	5.2	V	10mA max
Reliability			1	FPMH	40°C 80% load
Size	60 x 35 x 35			mm	LxWxH
weight		70		g	
Wire size	10	12		AWG	

Nevo+600 Series module OPA3: 9-30V 300W

FiDUS
power in motion...

300 Watts

- Peak power 450W (5 sec)
- Remote current and voltage programming
- Current share in parallel operation
- Remote sense
- 5 Year warranty



Parameter	Min	Typical	Max	Units	Notes & Conditions
Output voltage range	9	24	30	V	Manual adjustment
Output current rating			15	A	
Output power rating			300	W	
Peak power rating			450	W	Max 5 seconds
Initial voltage setting accuracy	-0.5		0.5	%	Factory set units
Manual voltage adjust		1.909		V/turn	11 turn potentiometer
Load regulation	-150		150	mV	Measured at sense terminals
Line regulation	-0.1		0.1	% Vnom	Measured at sense terminals
Cross regulation	-0.2		0.2	% Vnom	Measured at sense terminals
Minimum Load	0			W	
Temperature coefficient	-0.02		+0.02	% /°C	
Noise and ripple			1	% Vnom	20MHz bandwidth pk-pk
Transient response			3 100	V us	25%-75% load transient at 0.25A/us. Recovery within 10% of Vset
Turn on rise time	1.5		3.5	ms	Monotonic 10%-90%
Turn on overshoot			0.1	% Vset	
Turn on delay		600	750	ms	AC-Power good
		15	20	ms	Enable to power good
Current share accuracy	-5		+5	%	Error from ideal sharing current. Valid for loads > 20% of rating
Open sense offset			2	% Vnom	Voltage offset between sense lines and output terminals when sense lines unused
Holdup voltage			24	V	
Isolation to ground			250	V	Each output terminal
Overcurrent protection	105	115	125	%Inom	
Reverse current protection	-6		0	%Inom	
Short circuit protection		125/3/3.5		ms/%V	Period/Duty cycle/Voltage Threshold (Measured at sense terminals)
Overvoltage protection		36		V	Latching
Over temperature protection	115		125	°C	Internally monitored
Sense cable protection	-1		2	V	Positive
			1	V	Negative
Power good threshold		90		% Vset	Low threshold only
Current output signal	0		125	%Rated	I _{sig} = 0.6 + I _{out} / (IRTD * 1.25)
Current limit control	0		100	%Rated	I _{limit} = (V _{ctrl} - 0.6) * IRTD * 1.25
Remote voltage control	0		131.5	% Vset	V _{out} = Vset ((1.8 - V _{ctrl}) / 0.6)
Bias supply	4.5	5	5.2	V	10mA max
Reliability			1	FPMH	40°C 80% load
Size	60 x 35 x 35			mm	LxWxH
weight		70		g	
Wire size	16	14	10	AWG	