

## CP3500AC65TEZ High Efficiency Power Supply

Input: 100-240 Vac; 3500W capable; 65 Vdc @ 3500W; 5 Vdc @ 10W

### RoHS Compliant



### Applications

- Lasers
- RF Power Amplifiers
- Industrial Battery Chargers

### Features

- Efficiency exceeding 96%<sup>1</sup> (meets 80+ Titanium)
- Compact 1RU form factor with 40 W/in<sup>3</sup> density
- 3500W from nominal 200-240V<sub>AC</sub>
- 1500W from nominal 100 – 120V<sub>AC</sub> for V<sub>O</sub> > 40V<sub>DC</sub>
- Output voltage programmable from 23V – 65V<sub>DC</sub>
- ON/OFF control of the main output
- Comprehensive input, output and over-temp. protection
- PMBus compliant I<sup>2</sup>C serial bus and RS485
- Precision measurement reporting such as input power consumption, input/output voltage & current
- Remote firmware upgrade capable
- Power factor correction (meets EN/IEC 61000-3-2 requirements)
- Redundant, parallel operation with active load sharing
- Redundant +5V @ 2A Aux power
- Internally controlled Variable-speed fan
- Hot insertion/removal (hot plug)
- Four front panel LED indicators
- UL and cUL approved to UL/CSA<sup>†</sup>62368-1, TUV (EN62368-1), CE<sup>§</sup> Mark (for LVD) and CB Report available
- Constant Voltage
- Black faceplate
- Conformally coated PCB assemblies
- RoHS Directive 2011/65/EU and amended Directive (EU) 2015/863
- Compliant to REACH Directive (EC) No 1907/2006

### Description

The CP3500AC65TEZ power supply has an extremely wide programmable output voltage capability. High-density front-to-back airflow is designed for minimal space utilization and is highly expandable for future growth. This power supply incorporates both RS485 and I<sup>2</sup>C communications busses that allow it to be used in a broad range of applications. Feature set flexibility makes this power supply an excellent choice for a set of applications requiring operation over a wide output voltage range.

<sup>1</sup> At output voltages between 61Vdc and 65Vdc

## CP3500AC65TEZ High Efficiency Power Supply

Input: 100-240 Vac; 3500W capable; 65 Vdc @ 3500W; 5 Vdc @ 10W

- \* UL is a registered trademark of Underwriters Laboratories, Inc.
- † CSA is a registered trademark of Canadian Standards Association.
- ‡ VDE is a trademark of Verband Deutscher Elektrotechniker e.V.
- § This product is intended for integration into end-user equipment. All CE marking procedures of end-user equipment should be followed.
- \*\* ISO is a registered trademark of the International Organization of Standards
- † The PMBus name and logo are registered trademarks of the System Management Interface Forum (SMIF)

### Absolute Maximum Ratings

Stresses in excess of the absolute maximum ratings can cause permanent damage to the device. These are absolute stress ratings only. Functional operation of the device is not implied at these or any other conditions in excess of those given in the operations sections of the data sheet. Exposure to absolute maximum ratings for extended periods can adversely affect the device reliability.

Parameter	Symbol	Min	Max	Unit
Input Voltage: Continuous	$V_{IN}$	0	264	$V_{AC}$
Operating Ambient Temperature <sup>2</sup>	$T_A$	-25	75	°C
Storage Temperature	$T_{stg}$	-40	85	°C
I/O Isolation voltage to Frame (100% factory Hi-Pot tested)			1500	$V_{AC}$

### Electrical Specifications

Unless otherwise indicated, specifications apply over all operating input voltage,  $V_o=61V_{DC}$ , resistive load, and temperature conditions.

INPUT								
Parameter	Symbol	Min	Typ	Max	Unit			
Startup Voltage	$V_{IN}$		85	90	$V_{AC}$			
Low-line Operation						80	185	
High-line Operation								
Operating Voltage Range						90	100 – 120	140
Low-line Configuration						185	200 - 240	265
High-line Configuration								
Voltage Swell (no damage)		275						
Turn OFF Voltage		75	80	85				
Hysteresis		5						
Frequency	$F_{IN}$	47		66	Hz			
Source Impedance (US NEC allows 2.5% of source voltage drop inside a building)			0.2		$\Omega$			
Operating Current; at 110 $V_{AC}$ at 240 $V_{AC}$	$I_{IN}$		15.5 16		$A_{AC}$			
Inrush Transient (220 $V_{RMS}$ , 25°C, excluding X-Capacitor charging)	$I_{IN}$		25	40	$A_{PK}$			
Idle Power (at 240 $V_{AC}$ , 25°C) 65V OFF 65V ON @ $I_o=0$	$P_{IN}$		9 18		W			
Leakage Current (300 $V_{AC}$ , 60Hz)	$I_{IN}$		2.5	3.5	mA			
Power Factor (50 – 100% load)	PF	0.97	0.995					
Efficiency <sup>3</sup> , 240 $V_{AC}$ , 65 $V_{DC}$ , @ 25°C 10% of FL 20% of FL 50% of FL FL	$\eta$	90 94 96 91			%			
Holdup time (output allowed to decay down to 30 $V_{DC}$ ) For loads below 1500W	T		10 15		ms			
Ride through (at 240 $V_{AC}$ , 25°C)	T	1/2	1		cycle			

<sup>2</sup> See the derating guidelines under the Environmental Specifications section

<sup>3</sup> Fan disabled, 5V output at 0 load.

## CP3500AC65TEZ High Efficiency Power Supply

Input: 100-240 Vac; 3500W capable; 65 Vdc @ 3500W; 5 Vdc @ 10W

Power Good Warning <sup>4</sup> (main output allowed to decay to 30V <sub>DC</sub> )	PG	3	5		ms
Isolation (per EN62368-1) (consult factory for testing to this requirement)					
Input-Chassis/Signals	V	1500			V <sub>AC</sub>
Input - Output		3000			V <sub>AC</sub>

## Electrical Specifications (continued)

MAIN OUTPUT						
Parameter	Symbol	Min	Typ	Max	Unit	
Output Power <sup>5</sup> @ low line input 100 – 120V <sub>AC</sub> , V <sub>O</sub> > 55V <sub>DC</sub> @ high line input 200 – 240V <sub>AC</sub> <sup>6</sup> , V <sub>O</sub> > 55V <sub>DC</sub>	W	1500 3500			W <sub>DC</sub>	
Factory set default set point			23		V <sub>DC</sub>	
Overall regulation (load, temperature, aging) 0 - 45°C LOAD > 2.5A > 45°C	V <sub>OUT</sub>	-1 -2		+1 +2	%	
Output Voltage Set Range		23		65	V <sub>DC</sub>	
Response to a ΔV ≤ 10V Vprog change command	T		250	350	ms	
Response to a ΔV ≤ 10V i2c instruction			50	70	ms	
Output Current - @ 1500W (100 – 120Vac), 61V @ 3500W (200 – 240V <sub>AC</sub> ), 61V	I <sub>OUT</sub>	1 1		24.6 57.4	A <sub>DC</sub>	
Current Share (> 50% FL) V <sub>O</sub> > 30 to 65 V <sub>DC</sub>		-5		5	%FL	
Output Ripple (20MHz bandwidth, load > 1A) RMS (5Hz to 20MHz) Peak-to-Peak (5Hz to 20MHz)	V <sub>OUT</sub>			200 500	mV <sub>rms</sub> mV <sub>p-p</sub>	
External Bulk Load Capacitance	C <sub>OUT</sub>	0		5,000	μF	
Turn-On (monotonic turn-ON from 30 – 100% of V <sub>nom</sub> above 5°C) Delay			5		s	
Rise Time – PMBus mode	T		100		ms	
Rise Time - RS-485 mode <sup>7</sup>			5		s	
Output Overshoot	V <sub>OUT</sub>			2	%	
Load Step Response (I <sub>O,START</sub> > 2.5A ) ΔI <sup>8</sup> ΔV, Response Time	I <sub>OUT</sub> V <sub>OUT</sub> T		2.0 2	50	%FL V <sub>DC</sub> ms	
Output Characteristic	Power limit, high line (at 65V <sub>DC</sub> )	P <sub>OUT</sub>	3500		W	
	Low line	P <sub>OUT</sub>	1500		W	
The overload current limit threshold is ≅ 2% above the load shown here <sup>9</sup>						

<sup>4</sup> Internal protection circuits may override the PG signal and may trigger an immediate shutdown. PG should not indicate normal (HI) until the main output is within regulation. PG should be asserted if the main output is about to shut down for any detectable reason.

<sup>5</sup> Output power capability is either 3500W or 1500W depending on high or low line operation. High line operation is shown above.

<sup>6</sup> Input line range: 90 – 264 V<sub>RMS</sub> (±10%)

<sup>7</sup> Below -20°C, the rise time is approximately 5 minutes to protect the bulk capacitors. RS485 mode walk-in can be disabled.

<sup>8</sup> di/dt (output current slew rate) 1A/μs.

<sup>9</sup> Overload shutdown is delayed for 3 seconds to allow the equipment to reduce utilized power. Increase in fan speed is also delayed 500ms.

CP3500AC65TEZ High Efficiency Power Supply

Input: 100-240 Vac; 3500W capable; 65 Vdc @ 3500W; 5 Vdc @ 10W

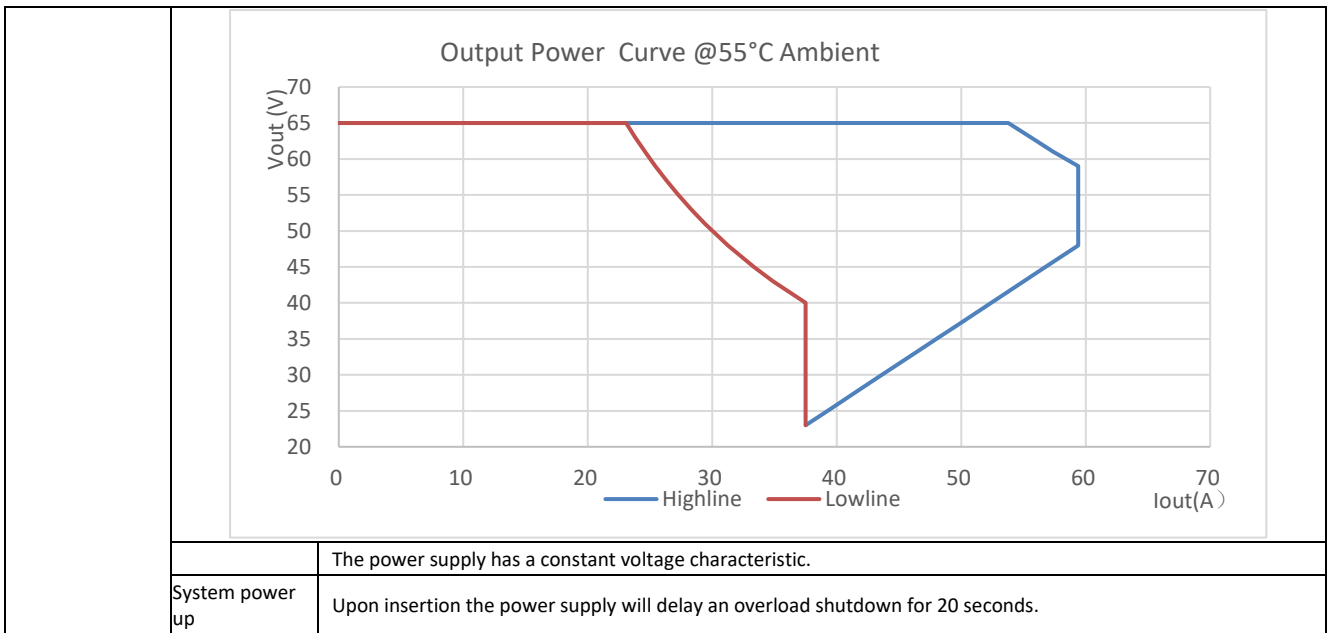

Electrical Specifications (continued)

MAIN OUTPUT					
Parameter	Symbol	Min	Typ	Max	Unit
Overvoltage - 200ms delayed shutdown Immediate shutdown Latched shutdown	V <sub>OUT</sub>	> 70		< 67	V <sub>DC</sub>
Three restart attempts are implemented within a 1 minute window prior to a latched shutdown.					
Over-temperature warning (prior to commencement of shutdown) Shutdown (below the max device rating being protected) Restart attempt Hysteresis (below shutdown level)	T		5 20 10		°C
Isolation Output-Chassis (Standard)	V	1500			V <sub>DC</sub>

5V <sub>DC</sub> Auxiliary output					
Parameter	Symbol	Min	Typ	Max	Unit
Output Voltage Setpoint	V <sub>OUT</sub>		5		V <sub>DC</sub>
Overall Regulation		-3		+3	%
Output Current		0.005		2	A
Ripple and Noise (20mHz bandwidth)			50	100	mV <sub>p-p</sub>
Over-voltage Clamp				7	V <sub>DC</sub>
Over-current Limit		110		175	%FL

The 5V<sub>DC</sub> should be ON before availability of the 65V<sub>DC</sub> main output and should turn OFF only if insufficient input voltage exists to provide reliable 5V<sub>DC</sub> power. The PG# signal should have indicated a warning that power would get turned OFF and the 65V<sub>DC</sub> main output should be OFF way before interruption of the 5V<sub>DC</sub> output.

General Specifications

Parameter	Min	Typ	Max	Units	Notes
Reliability		450,000		Hours	Full load, 25°C ; MTBF per SR232 Reliability protection for electronic equipment, issue 2, method I, case III,

CP3500AC65TEZ High Efficiency Power Supply

Input: 100-240 Vac; 3500W capable; 65 Vdc @ 3500W; 5 Vdc @ 10W

Service Life		10		Years	Full load, excluding fans
Unpacked Weight		2.18/4.8		Kgs/Lbs	
Packed Weight		2.45/5.4		Kgs/Lbs	
Heat Dissipation	190 Watts or 648 BTUs @ 80% load, 250 Watts or 853 BTUs @ 100% load				

## CP3500AC65TEZ High Efficiency Power Supply

Input: 100-240 Vac; 3500W capable; 65 Vdc @ 3500W; 5 Vdc @ 10W

## Signal Specifications

Unless otherwise indicated, specifications apply over all operating input voltage, resistive load, and temperature conditions. Signals are referenced to Logic\_GRD unless noted otherwise. Fault, PG#, OTW, and Alert need to be pulled HI through external pull-up resistors.

Parameter	Symbol	Min	Typ	Max	Unit
ON/OFF Main output OFF	$V_{OUT}$	$0.7V_{DD}$	—	5	$V_{DC}$
65V output ON (should be connected to Logic_GRD)	$V_{OUT}$	0	—	0.5	$V_{DC}$
Margining (through adjusting Vprog)		23		65	$V_{DC}$
Voltage control range	$V_{control}$	0		3.3	$V_{DC}$
Programmed output voltage range (0.1V to 3.0V in 255 steps)	$V_{OUT}$	23		65	$V_{DC}$
Voltage adjustment resolution (8-bit A/D)	$V_{control}$		165		mV <sub>DC</sub>
Output configured to default output (factory set default output is 23V)	$V_{control}$	3.0		3.3	$V_{DC}$
Output configured to 23V <sub>DC</sub>	$V_{control}$	0		0.1	$V_{DC}$
Interlock		[short pin shorted to VOUT( - ) on system side]			
Module Present		[short pin to Logic_GRD internally]			
Power Good (PG) Logic HI (temperature normal)	V	$0.7V_{DD}$	—	12	$V_{DC}$
Sink current [note: open collector output FET]	I	—	—	5	mA
Logic LO (temperature is too high)	V	0	—	0.4	$V_{DC}$
Protocol select Logic HI - Analog/PMBus™ mode	$V_{IH}$	2.7	—	3.5	$V_{DC}$
Logic – intermediate – RS485 mode	$V_{II}$	1.0	—	2.65	$V_{DC}$
Logic LO – DSP reprogram mode	$V_{IL}$	0	—	0.4	$V_{DC}$
Fault# Logic HI (No fault is present)	V	$0.7V_{DD}$	—	12	$V_{DC}$
Sink current	I	—	—	5	mA
Logic LO (Fault is present)	V	0	—	0.4	$V_{DC}$
Alert# Logic HI (No Alert - normal)	V	$0.7V_{DD}$	—	12	$V_{DC}$
Sink current [note: open collector output FET]	I	—	—	5	mA
Logic LO (Alert# is set)	V	0	—	0.4	$V_{DC}$
SCL, SDA Logic HI	V	2.1	—	12	$V_{DC}$
Sink current [note: open collector output FET]	I	—	—	5	mA
Logic LO (Alert# is set)	V	0	—	0.4	$V_{DC}$

## CP3500AC65TEZ High Efficiency Power Supply

Input: 100-240 Vac; 3500W capable; 65 Vdc @ 3500W; 5 Vdc @ 10W

## Digital Interface Specifications

Parameter	Conditions	Symbol	Min	Typ	Max	Unit
<b>PMBus Signal Interface Characteristics<sup>10</sup></b>						
Input Logic High Voltage (CLK, DATA)		V	2.1		12	V <sub>DC</sub>
Input Logic Low Voltage (CLK, DATA)		V	0		0.8	V <sub>DC</sub>
Input high sourced current (CLK, DATA)		I	0		10	μA
Output Low sink Voltage (CLK, DATA, ALERT#)	I <sub>OUT</sub> =3.5mA	V			0.4	V <sub>DC</sub>
Output Low sink current (CLK, DATA, ALERT#)		I	3.5			mA
Output High open drain leakage current (CLK, DATA, ALERT#)	V <sub>OUT</sub> =3.6V	I	0		10	μA
PMBus Operating frequency range	Slave Mode	FPMB	10		400	kHz
<b>Measurement System Characteristics</b>						
Clock stretching		T <sub>stretch</sub>			25	ms
I <sub>OUT</sub> measurement range		I <sub>rng</sub>	0		80	A <sub>DC</sub>
I <sub>OUT</sub> measurement accuracy 25°C	> 12.8A < 12.8A	I <sub>out(acc)</sub>	-1 5		+1 5	% of FL %
I <sub>OUT</sub> measurement accuracy 0 - 40°C <sup>11</sup>	> 12.8A	I <sub>out(acc)</sub>	-2		+2	% of FL
V <sub>OUT</sub> measurement range		V <sub>out(rng)</sub>	0		140	V <sub>DC</sub>
V <sub>OUT</sub> measurement accuracy <sup>12</sup>		V <sub>out(acc)</sub>	-1		+1	%
Temp measurement range		Temp <sub>(rng)</sub>	0		150	°C
Temp measurement accuracy <sup>13</sup>		Temp <sub>(acc)</sub>	-4		+4	°C
V <sub>IN</sub> measurement range		V <sub>in(rng)</sub>	0		320	V <sub>AC</sub>
V <sub>IN</sub> measurement accuracy @ 25°C	V <sub>IN</sub> > 120V <sub>AC</sub> V <sub>IN</sub> < 120V <sub>AC</sub>	V <sub>in(acc)</sub>	-1.25 -2		+1.25 2	%
I <sub>IN</sub> measurement range		I <sub>in(rng)</sub>	0		30	I <sub>AC</sub>
I <sub>IN</sub> measurement accuracy - measurement @ 25°C		I <sub>in(acc)</sub>	-4		+4	% of FL
P <sub>IN</sub> measurement range		P <sub>in(rng)</sub>	0		4000	W <sub>in</sub>
P <sub>IN</sub> measurement accuracy – measurement @ 25°C	> 350W < 350W	P <sub>in(acc)</sub>	-5	35	+5 50	% W
Fan Speed measurement range			0		30k	RPM
Fan Speed measurement accuracy			-10		10	%
Fan speed control range			0		100	%

<sup>10</sup> Clock, Data, and Alert# need to be pulled up to V<sub>DD</sub> externally.<sup>11</sup> **Below 20% of FL**; 10 – 20% of FL: ±0.64A; 5 – 10% of FL: ±0.45A; 2.5 – 5% of FL: ±0.32A.<sup>12</sup> Above 2.5A of load current<sup>13</sup> Within 30° of the default warning and fault levels.

## CP3500AC65TEZ High Efficiency Power Supply

Input: 100-240 Vac; 3500W capable; 65 Vdc @ 3500W; 5 Vdc @ 10W

## Environmental Specifications

Parameter	Min	Typ	Max	Units	Notes
Ambient Temperature	-40 <sup>14</sup>		55	°C	Air inlet from sea level to 5,000 meters
Exhaust Air Temperature			15	°C	Maximum allowed internal temperature rise
Storage Temperature	-40		85	°C	
Operating Altitude			5000/16400	m / ft	Above sea level
Non-operating Altitude			8200/26900	m / ft	Above sea level
Power Derating with Altitude			2.0 4.0	%/305 m %/1000 ft	Above 1524/5000 m/ft; Above 5000m de-rate 4% per 305m (1000 ft)
Power Derating with Temperature			2.0	%/°C	55°C to 75°C
Acoustic noise		55		dbA	Full load
Over Temperature Protection		125/110		°C	Shutdown / restart [internally measured points]
Humidity Operating Storage	5 5		95 95	% %	Relative humidity, non-condensing
Shock and Vibration acceleration			2.4	Grms	IPC-9592B, Class II

## EMC

Parameter	Measurement	Standard	Level	Test	
AC input <sup>15</sup>	Conducted emissions	EN55032, FCC Docket 20780 part 15, subpart J EN61000-3-2 Meets EN 55032 Class A with a 6dB Margin Meets Telcordia GR1089-CORE by a 3dB margin	A	0.15 – 30MHz 0 – 2 kHz	
	Radiated emissions	EN55032 to comply with system enclosure	A	30 – 10000MHz	
Parameter	Measurement	Standard	Criteria <sup>16</sup>	Test	
AC Input Immunity	Line sags and interruptions	EN61000-4-11	B	-30%, 10ms	
			B	-60%, 100ms	
			B	-100%, 5sec	
	Lightning surge	EN61000-4-5, Level 4, 1.2/50µs – error free  ANSI C62.41 - level A3	B	Output will stay above 55V <sub>DC</sub> @ 75% load Sag must be higher than 80V <sub>rms</sub> .	25% line sag for 2 seconds 1 cycle interruption
			A	4kV, common mode	
			A	2kV, differential mode	
Fast transients	EN61000-4-4, Level 3	B	6kV, common & differential	5/50ns, 2kV (common mode)	
Enclosure immunity	Conducted RF fields	EN61000-4-6, Level 3	A	130dBµV, 0.15-80MHz, 80% AM	
	Radiated RF fields	EN61000-4-3, Level 3	A	10V/m, 80-1000MHz, 80% AM	
		ENV 50140	A		
	ESD	EN61000-4-2, Level 4	B	8kV contact, 15kV air	

<sup>14</sup> Designed to start and work at an ambient as low as -40°C, but may not meet operational limits until above -5°C. This could impact output voltage ripple, hold-up, and start-up into high loads.

<sup>15</sup> Emissions requirements can be verified using a GE 19" shelf. In standalone use, the additional margin is not required.

<sup>16</sup> Criterion A: The product must maintain performance within specification limits. Criterion B: Temporary degradation which is self-recoverable. Criterion C: Temporary degradation which requires operator intervention.



# CP3500AC65TEZ High Efficiency Power Supply

Input: 100-240 Vac; 3500W capable; 65 Vdc @ 3500W; 5 Vdc @ 10W

## Characteristic Curves

The following figures provide typical characteristics for the CP3500AC65TEZ at 25°C.

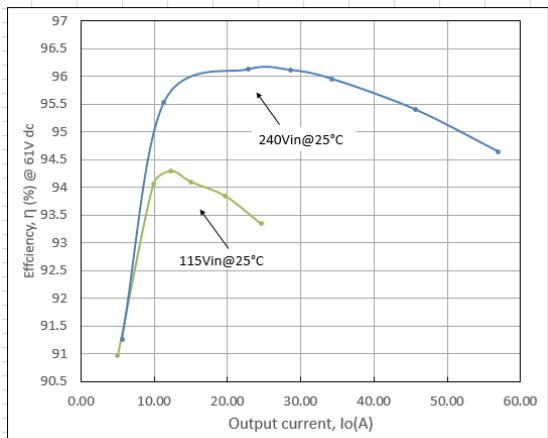

Figure 1. Power Supply Efficiency versus Output Current.

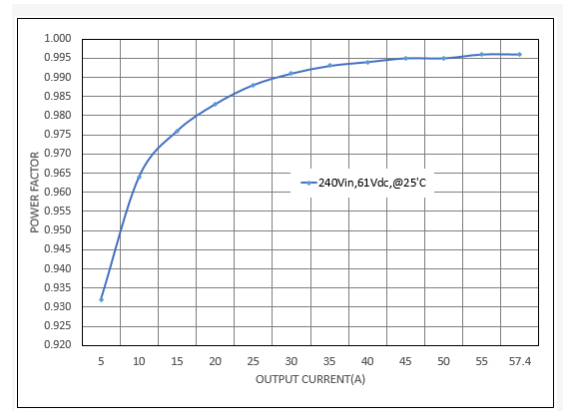

Figure 2. Power Factor versus Output Current

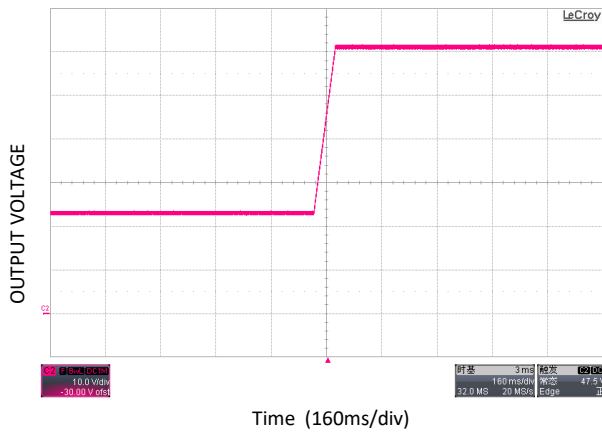

Figure 3. Main output: Output changed from 23V to 65V; commanded via I<sup>2</sup>C.

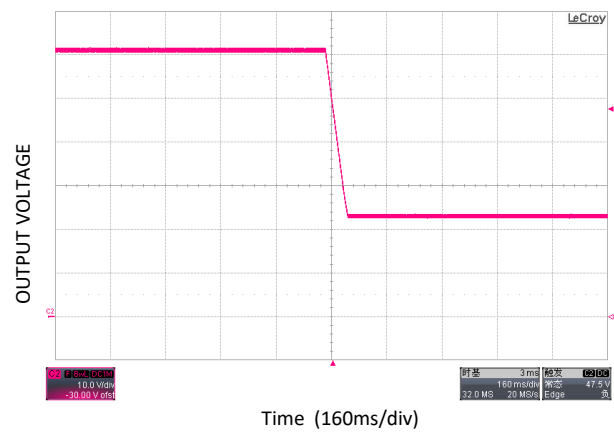

Figure 4. Main output: Output changed from 65V to 23V; commanded via I<sup>2</sup>C.

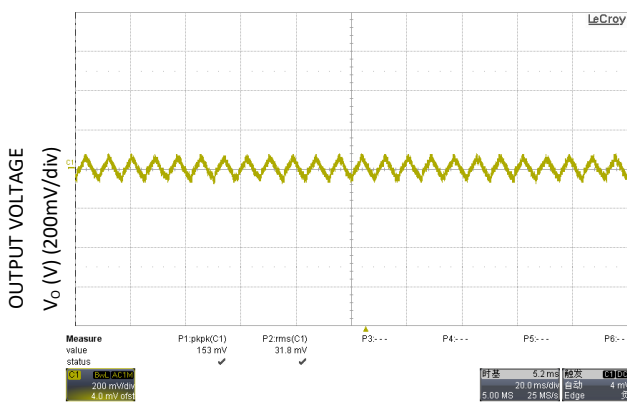

Figure 5. 65V<sub>DC</sub> output ripple and noise, full load, V<sub>IN</sub> = 185V<sub>AC</sub>, 20MHz bandwidth

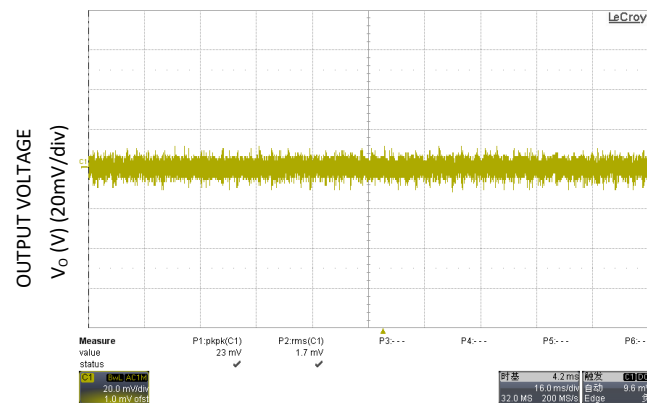

Figure 6. 5V<sub>DC</sub> output ripple and noise, all full load, V<sub>IN</sub> = 185V<sub>AC</sub>, 20MHz bandwidth

# CP3500AC65TEZ High Efficiency Power Supply

Input: 100-240 Vac; 3500W capable; 65 Vdc @ 3500W; 5 Vdc @ 10W

## Characteristic Curves (continued)

The following figures provide typical characteristics for the CP3500AC65TEZ at 25°C.

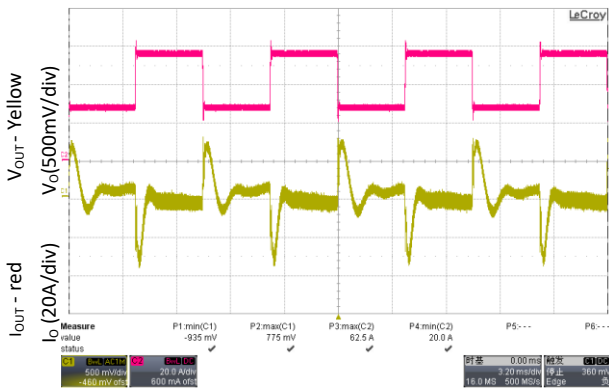

Figure 7. Transient response 65V<sub>DC</sub> load step 10 – 60%, Slew rate: 1A/ $\mu$ s,  $V_{IN}$  = 230V<sub>AC</sub>

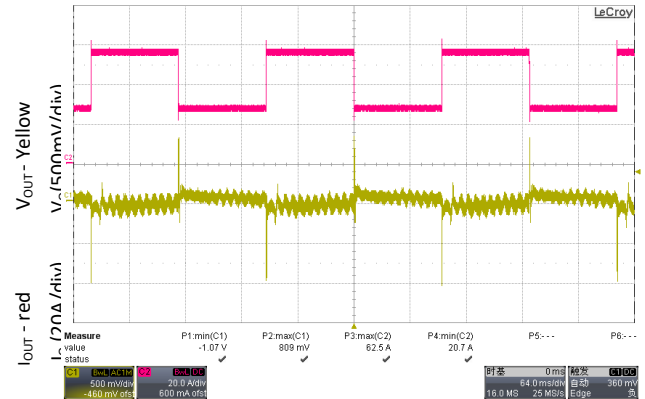
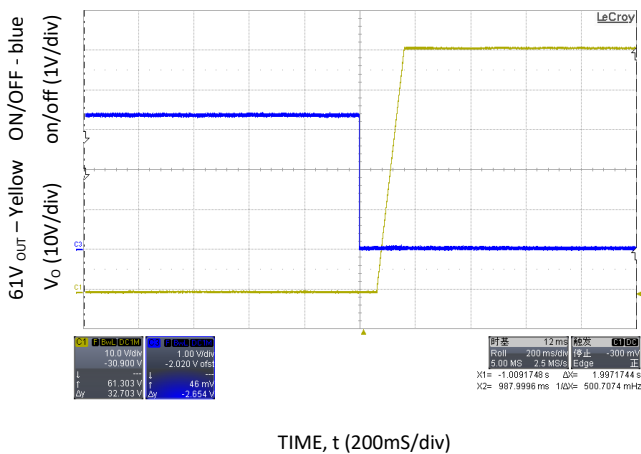
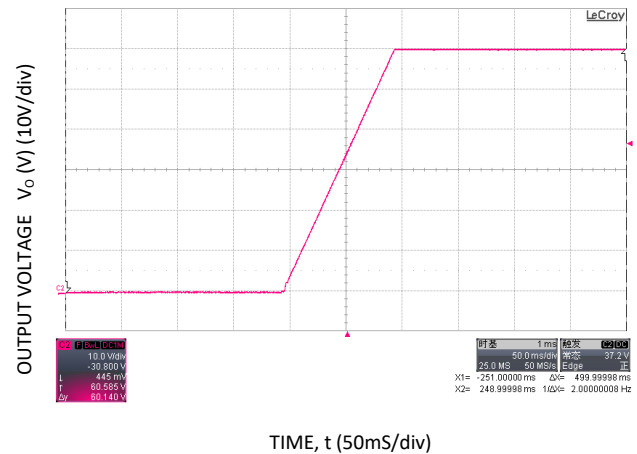

Figure 8. Transient response 65V<sub>DC</sub> load step 10 – 60%, Slew rate: 1A/ $\mu$ s,  $V_{IN}$  = 230V<sub>AC</sub>



TIME, t (200ms/div)

Figure 9. 65V<sub>DC</sub> soft start delay when ON/OFF is asserted,  $V_{IN}$ =230V<sub>AC</sub> - I<sup>2</sup>C mode.



TIME, t (50ms/div)

Figure 10. 65V<sub>DC</sub> soft start, full load,  $V_{IN}$  = 230V<sub>AC</sub> - I<sup>2</sup>C mode with 4700 $\mu$ f external capacitance.

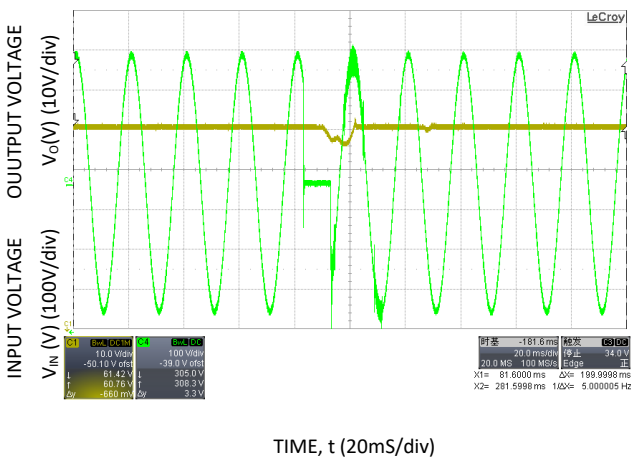

TIME, t (20ms/div)

Figure 11. Ride through missing 1/2 cycle, full load,  $V_{IN}$  = 230V<sub>AC</sub>.

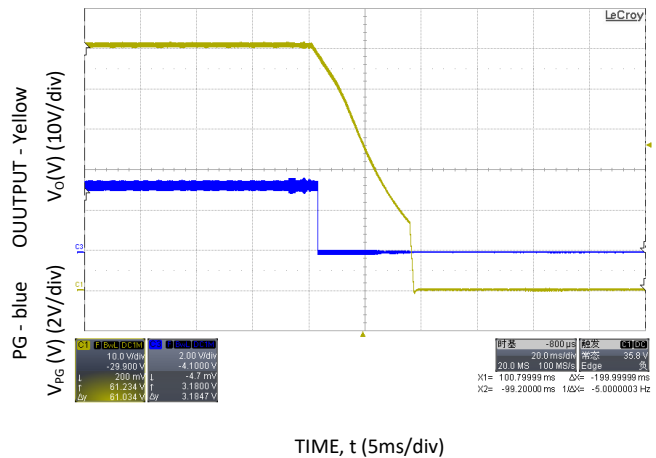

TIME, t (5ms/div)

Figure 12. PG# alarmed 10ms prior to  $V_{out}$  < 30V,  $V_{IN}$  = 230V<sub>AC</sub>, Output at Full load

# CP3500AC65TEZ High Efficiency Power Supply

Input: 100-240 Vac; 3500W capable; 65 Vdc @ 3500W; 5 Vdc @ 10W

## Characteristic Curves (continued)

The following figures provide typical characteristics for the CP3500AC65TE power supply at 25°C.

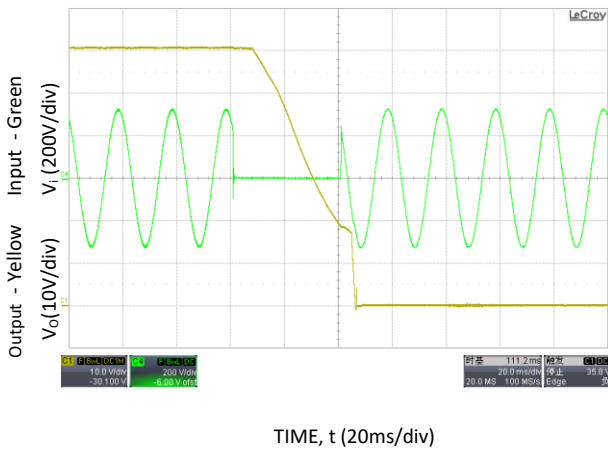

Figure 13. 40ms AC dropout @ full load,  $V_{IN} = 230V_{AC}$ .

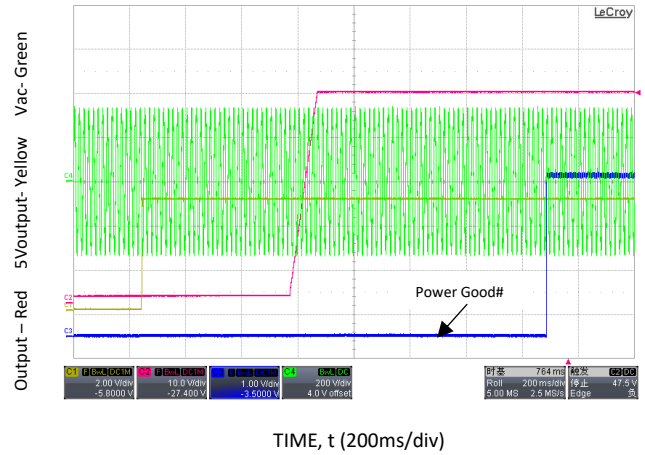

Figure 14. Turn-ON at full load  $V_{IN} = 230V_{AC}$ .

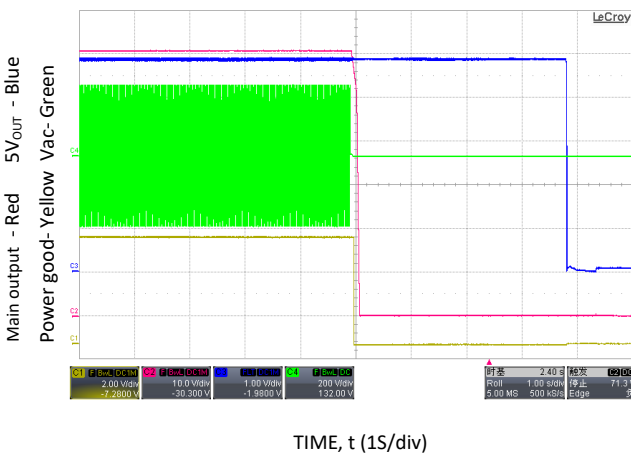

Figure 15. Turn-OFF at full load,  $V_{IN}=230V_{AC}$

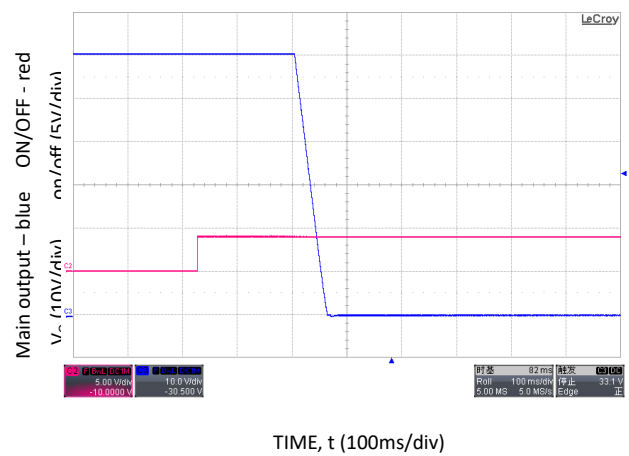

Figure 16. 65V<sub>DC</sub> turn-OFF delay when ON/OFF is di-asserted,  $V_{IN}=230V_{AC}$  - I<sup>2</sup>C mode.

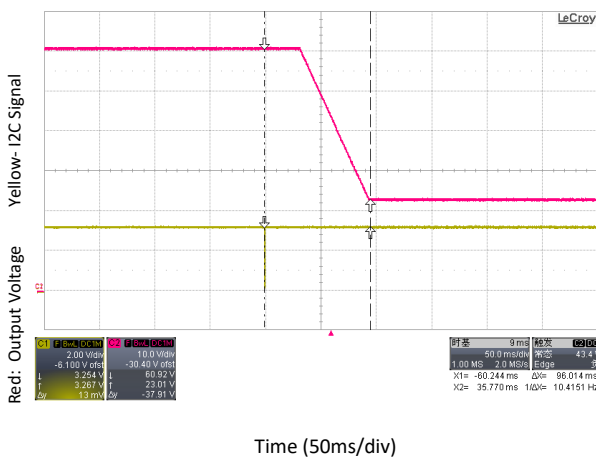

Figure 17: Time delay from sending the I<sup>2</sup>C command and executing the output voltage change.

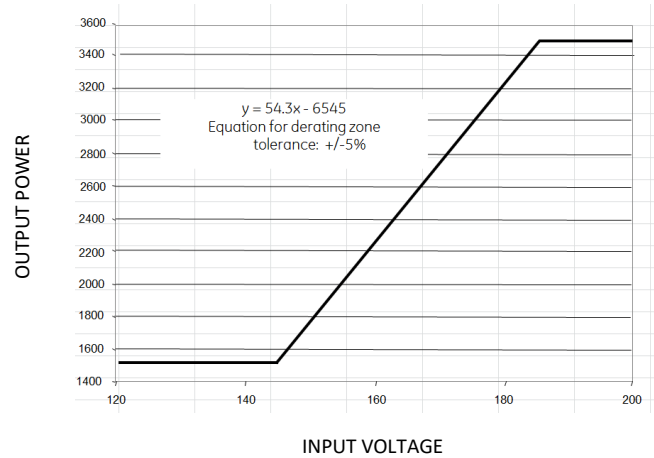
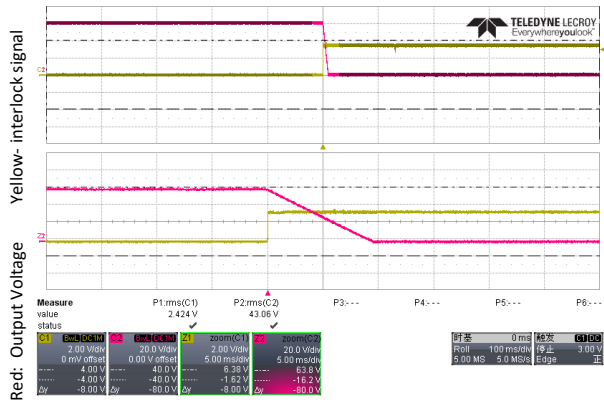

Figure 18. Output power derating below  $V_{IN}$  of 185V<sub>AC</sub>

# CP3500AC65TEZ High Efficiency Power Supply

Input: 100-240 Vac; 3500W capable; 65 Vdc @ 3500W; 5 Vdc @ 10W



Zoom in Time (5ms/div)

**Figure 19: Time delay from interlock reverse and output shut down. interlock signal can be used as quick turn off signal.**

## CP3500AC65TEZ High Efficiency Power Supply

Input: 100-240 Vac; 3500W capable; 65 Vdc @ 3500W; 5 Vdc @ 10W

### Timing diagram

#### Response to input fluctuations

Here is the timing diagram for the power supply:

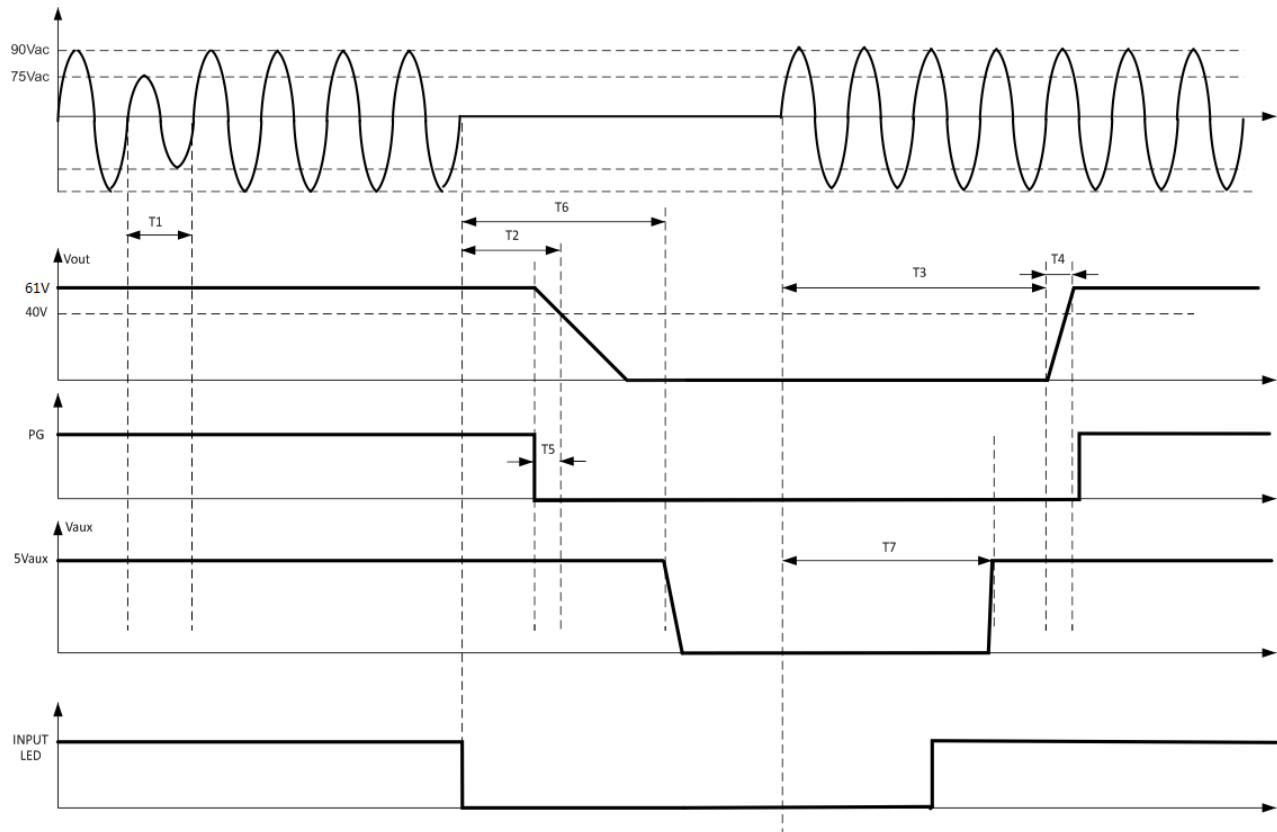

T1 – ride through time – 0.5 to 1 cycles [ 10 – 20ms]  $V_{OUT}$  remains within regulation – load dependent

T2 – hold up time - 15ms –  $V_{OUT}$  stays above 30V<sub>DC</sub>

T3 – delay time – 10s – from when the AC returns within regulation to when the output starts rising in I<sup>2</sup>C mode

T4 – rise time - 120ms – the time it takes for  $V_{OUT}$  to rise from 10% to 90% of regulation in I<sup>2</sup>C mode

T5 – power good warning – 3ms – the time between assertion of the PG signal and the output decaying below 30V<sub>DC</sub>.

T6 – hold up time of the 5VAUX output @ full load – 1s – from the time AC input failed

T7 – rise time of the 5VAUX output - 3.65ms – 5VAUX is available at least 450ms before the main output is within regulation

Blinking of the input/AC LED –  $V_{IN} < 80V_{AC}$  (the low transitioned signal represents blinking of the input LED).

## CP3500AC65TEZ Global Platform High Efficiency Power Supply

Input: 100-240 Vac; 3500W capable; 65 Vdc @ 3500W; 5 Vdc @ 10W

### Control and Status

The power supply provides three means for monitor/control: analog, PMBus™, or the GE Galaxy-based RS485 protocol.

Details of analog control and the PMBus™ based protocol are provided in this data sheet. GE will provide separate application notes on the Galaxy RS485 based protocol for users to interface to the power supply. Contact your local GE representative for details.

**Control hierarchy:** Some features, such as output voltage, can be controlled both through hardware and firmware. For example, the output voltage is controlled both by a signal pin (Vprog) and firmware (Vout\_command; 0x21).

Using output voltage as an example, the Vprog signal pin voltage level sets the output voltage if its value is between 0.1Vdc and 3V<sub>DC</sub>. (see the Vprog section). When the programming signal Vprog is a no connect, the output voltage is set at the default value of 23V<sub>DC</sub>. When the programming signal is between 0V and 0.1V, the output will be 23Vdc.

The signal pin controls the feature it is configuring until a firmware command is executed. However, once the firmware command has been executed, the signal pin is ignored. In the above example, the power supply will no longer 'listen' to the Vprog pin if the Vout\_command has been executed.

In summary, signals such as Vprog are utilized for setting the initial default value and for varying the value until firmware based control takes over. Once firmware control is executed, hardware based control is relinquished so the processor can clearly decide who has control.

**Analog controls:** Details of analog controls are provided in this data sheet under Feature Specifications.

**Signal Reference:** Unless otherwise noted, all signals are referenced to Logic\_GRD. See the Signal Definitions Table at the end of this document for further description of all the signals.

Logic\_GRD is isolated from the main output of the power supply for PMBus communications. Communications and the 5V standby output are not connected to main power return (Vout(-)) and can be tied to the system digital ground point selected by the user. (Note that RS485 communications is referenced to Logic\_Gnd because the output voltage can exceed the SELV limit).

Logic\_GRD is capacitively coupled to Frame\_GRD inside the power supply. The maximum voltage differential between Logic\_GRD and Frame\_GRD should be less than 100V<sub>DC</sub>.

**Delayed overcurrent shutdown during startup:** This power supply is programmed to stay in a constant current state for up to 20 seconds during power up. This delay has been introduced to permit the orderly application of input power to a subset of paralleled front-ends during power up. If the overload persists beyond the 20 second delay, the front-end will revert to its programmed state of overload protection.

**Unit in Power Limit or in Current Limit:** When output voltage is > 30V<sub>DC</sub> the Output LED will continue blinking.

When output voltage is < 23V<sub>DC</sub>, if the unit is in the RESTART mode, it goes into hiccup. When the unit is ON the output LED is ON, when the unit is OFF the output LED is OFF.

When the unit is in latched shutdown the output LED is OFF.

The power supply will delay overcurrent shutdown for 3 seconds to allow the user equipment to shed load. Voltages below 5Vdc are considered a deep overload/short circuit that will cause an immediate shutdown.

**Auto restart:** Auto-restart is the default configuration for over-current and over-temperature shutdowns. These features are configured by the PMBus™ fault\_response commands

An overvoltage shutdown is followed by three attempted restarts, each restart delayed 1 second, within a 1 minute window. If within the 1 minute window three attempted restarts failed, the unit will latch OFF. If within the 1 minute less than 3 shutdowns occurred then the count for latch OFF resets and the 1 minute window starts all over again.

**Restart after a latching off:** PMBus™ fault\_response commands can be configured to direct the power supply to remain latched off for over\_temperature and over\_current.

To restart after a latch off either of five restart mechanisms are available.

1. The hardware pin **ON/OFF** may be cycled OFF and then ON.
2. The unit may be commanded to restart via i2c through the *Operation* command by cycling the output OFF followed by ON.
3. Remove and reinsert the unit.
4. Turn OFF and then turn ON AC power to the unit.
5. Changing firmware from **latch off** to **restart**.

Each of these commands must keep the power supply in the OFF state for at least 2 seconds, with the exception of changing to **restart**.

A successful restart shall clear all alarm registers, set the **restarted successful** bit of the **Status\_2** register.

A power system that is comprised of a number of power supplies could have difficulty restarting after a shutdown event because of the non-synchronized behavior of the individual power supplies. Implementing the latch-off mechanism permits a synchronized restart that guarantees the simultaneous restart of the entire system.

A synchronous restart can be implemented by;

Issuing a GLOBAL OFF and then ON command to all power supplies,  
or Toggling Off and then ON the ON/OFF (ENABLE) signal or Removing and reapplying input power to the entire system.

The power supplies should be turned OFF for at least 20 – 30 seconds in order to discharge all internal bias supplies and reset the soft start circuitry of the individual power supplies.

# CP3500AC65TEZ High Efficiency Power Supply

Input: 100-240 Vac; 3500W capable; 65 Vdc @ 3500W; 5 Vdc @ 10W

## Control Signals

**Protocol:** This signal pin defines the communications mode setting of the power supply. Two different states can be configured. State #1 is the I<sup>2</sup>C application in which case the protocol pin should be left a no-connect. State #2 is the RS485 mode application in which case a resistor value between 1kΩ and 5kΩ should be present between this pin and Vout (-).

**Device address in I<sup>2</sup>C mode:** Address bits A3, A2, A1, A0 set the specific address of the μP in the power supply. With these four bits, up to sixteen (16) power supplies can be independently addressed on a single I<sup>2</sup>C bus. These four bits are configured by two signal pins, Unit\_ID and Rack\_ID. The least significant bit x (LSB) of the address byte is set to either **write [0]** or **read [1]**. A **write** command instructs the power supply. A **read** command accesses information from the power supply.

Device	Address	Address Bit Assignments (Most to Least Significant)							
		7	6	5	4	3	2	1	0
μP	40 – 4F	1	0	0	A3	A2	A1	A0	R/W
Broadcast	00	0	0	0	0	0	0	0	0
		MSB				LSB			

**Unit\_ID:** Up to 10 different units are selectable.

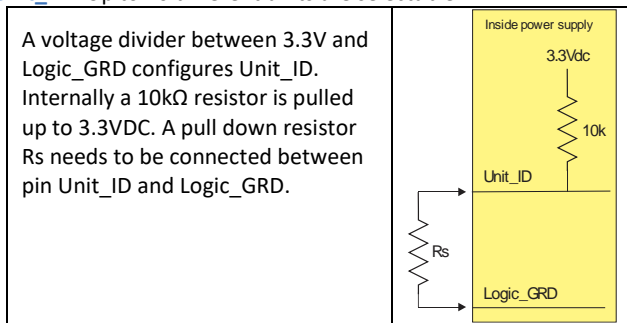

Unit_ID	Voltage level	R <sub>s</sub> (± 0.1%)
Invalid	3.30	
1	3.00	100k
2	2.67	45.3k
3	2.34	24.9k
4	2.01	15.4k
5	1.68	10.5k
6	1.35	7.15k
7	1.02	4.99k
8	0.69	2.49k
9	0.36	1.27k
10	0	0

**Rack\_ID:** Up to 8 different combinations are selectable.

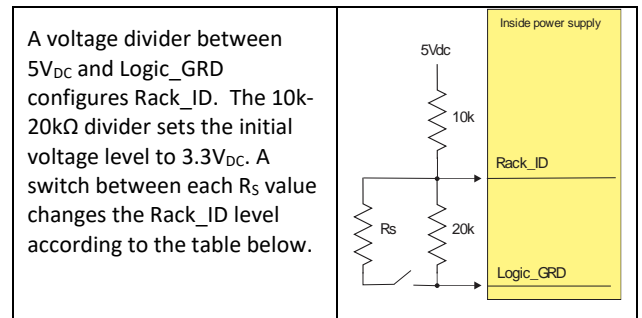

Rack_ID	Voltage level	R <sub>s</sub> (± 0.1%)
1	3.3	open
2	2.8	35.2k
3	2.3	15k
4	1.8	8k
5	1.4	4.99k
6	1	2.87k
7	0.5	1.27k
8	0	0

**Configuration of the A3 – A0 bits:** The power supply will determine the configured address based on the Unit\_ID and Rack\_ID voltage levels as follows (the order is A3 – A0):

		Unit_ID				
		1	2	3	4	5
Rack_ID	1	0000	0001	0010	0011	
	2	0100	0101	0110	0111	
	3	1000	1001	1010	1011	
	4	1100	1101	1110	1111	
	5					
	6	0000	0001	0010	0011	0100
	7	0101	0110	0111	1000	1001
	8	1010	1011	1100	1101	1110

**Unit x Rack: 4 x 4 and 5 x 3**

		Unit_ID				
		6	7	8	9	10
Rack_ID	1	0000	0001			
	2	0010	0011			
	3	0100	0101			
	4	0110	0111	0000	0001	0010
	5	1000	1001	0011	0100	0101
	6	1010	1011	0110	0111	1000
	7	1100	1101	1001	1010	1011
	8	1110	1111	1100	1101	1110

# CP3500AC65TEZ High Efficiency Power Supply

Input: 100-240 Vac; 3500W capable; 65 Vdc @ 3500W; 5 Vdc @ 10W

**Unit x Rack:** 2 x 8 and 3 x 5

**Address detection:** The **Slot\_ID** pin must be shorted to **Vout(-)** in order to deliver output power. This connection provides a second interlock feature. (In RS485 mode the **slot\_ID** resistance to **Vout(-)** is sufficient to sense the interlock feature)

**Device address in RS485 mode:** The address in RS485 mode is divided into three components; Bay\_ID, Slot\_ID and Shelf\_ID

**Bay\_ID:** The Unit\_ID definition in I<sup>2</sup>C mode becomes the bay id in RS485 mode.

**Slot\_ID:** Up to 10 different power supplies could be positioned across a 19" shelf if the power supplies are located vertically within the shelf. The resistor below needs to be placed between Slot\_ID and Vout (-). Internal pull-up to 3.3V is 10kΩ.

Slot	Resistor	Voltage	Slot	Resistor	Voltage
invalid	none	3.3V	6	7.15k	1.35V
1	100k	3V	7	4.99k	1.02V
2	45.3k	2.67V	8	2.49k	0.69V
3	24.9k	2.34V	9	1.27k	0.36V
4	15.4k	2.01V	10	0	0
5	10.5k	1.68V			

**Shelf\_ID:** When placed horizontally up to 10 shelves can be stacked on top of each other in a fully configured rack. The shelf will generate the precision voltage level tabulated below referenced to Vout (-).

Shelf	V <sub>MIN</sub>	V <sub>NOM</sub>	V <sub>MAX</sub>
1	2.3	2.5	2.7
2	4.7	5.0	5.3
3	7.4	7.5	7.6
4	9.5	10.0	10.5
5	11.8	12.5	13.2
6	14.2	15.0	15.8
7	16.6	17.5	18.4
8	19	20.0	21
9	21.3	22.5	23.6
10	23.8	25.0	26.3

**Global Broadcast:** Instruct all power supplies to respond simultaneously. The GLOBAL BROADCAST command should only be executed as a write instruction. The power supply should issue an 'invalid command' if a global 'read' is attempted.

An output voltage change instruction should be executed in ≤ 60ms for a ΔV of ≤ 10V.

A 'system' output voltage change for paralleled power supplies requires global broadcast. This command is also used to control the main output of a system. Unfortunately, this command is vulnerable to error. The ACK bit does not assure that all power supplies responded. To be certain that each power supply responded to the global instruction, a **READ**

instruction should be executed to each power supply to verify that the command properly executed.

**Voltage programming (V<sub>prog</sub>):** Hardware voltage programming controls the output voltage until a software command to change the output voltage is executed. Once a software voltage programming command is executed, the software voltage instruction permanently overrides the hardware margin setting. The power supply no longer listens to the hardware margin setting until power to the controller is interrupted, for example if input power or bias power is recycled.

An analog voltage level varies the output voltage from 23 to 65Vdc. (See timing limits under signal specifications)

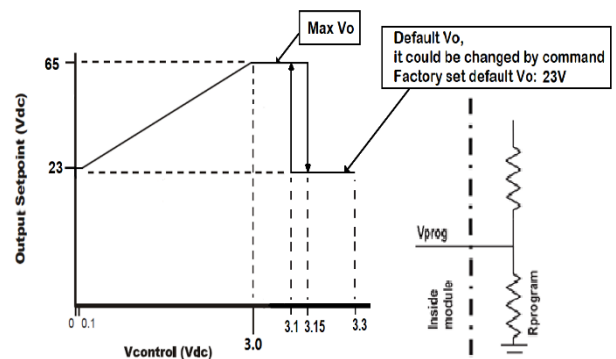

The V<sub>prog</sub> pin voltage level, which is referenced to Logic\_GRD, is configured by the user as shown in the graph above. It must be set in order for the power supply to know what its setting should be.

Programming of the V<sub>prog</sub> signal level can be accomplished either by a resistor divider or by a voltage source injecting a precision voltage level into the V<sub>prog</sub> pin. Above 3Vdc the power supply sets the output to default output. **Factory set default output is 23V.** Below 0.1Vdc, the power supply sets its output voltage to 23Vdc. See the accompanying implementation of hot plug for further information on hot-plug performance.

When bias power powering the controller is recycled, the controller restarts into its default configuration, programmed to set the output as instructed by the V<sub>prog</sub> pin. Again, subsequent software commanded instructions permanently override the margin setting.

If the output voltage of the power supply is software controlled, the Vprog voltage level should be set to a safety level that power supplies inserted into a live bus (hot plug) should be powered into, until subsequent software instructions tell the power supplies on the bus the desired output voltage setting. One such voltage level setting is 23Vdc. The hot plugged power supply will produce 23Vdc until it is commanded by the controller to another setting.



## CP3500AC65TEZ High Efficiency Power Supply

Input: 100-240 Vac; 3500W capable; 65 Vdc @ 3500W; 5 Vdc @ 10W

**Load share (Ishare):** This is a single wire analog signal that is generated and acted upon automatically by power supplies connected in parallel. Ishare pins should be connected to each other. No resistors or capacitors should get connected to this pin.

**ON/OFF:** Controls the main 65V<sub>DC</sub> output when either analog control or PMBus protocols are selected, as configured by the Protocol pin. This pin must be pulled low to turn **ON** the power supply. The power supply will turn **OFF** if either the **ON/OFF** or the **Interlock** pin is released. This signal is referenced to Logic\_GRD. Note that in RS485 mode this pin is ignored.

**Interlock:** This is a shorter pin utilized for hot-plug applications to ensure that the power supply turns **OFF** before the power pins are disengaged. It also ensures that the power supply turns **ON** only after the power pins have been engaged. Must be connected to V\_OUT (-) for the power supply to be ON.

**Module Present:** This signal is tied to Logic\_GRD inside the power supply. The intent is to provide a signal to the system that a power supply is present in the slot.

**8V\_INT:** Single wire connection between power supplies. It provides bias to the DSP of an unpowered power supply.

### Status Signals

**Power Good Warning (PG#):** This signal is HI when the main output is being delivered and goes LO if the main output is about to decay below regulation. Note that should a catastrophic failure occur, the signal may not be fast enough to provide a meaningful warning. PG# also pulses at a 1ms duty cycle if the unit is in overload.

**Fault#:** A TTL compatible status signal representing whether a Fault occurred. This signal needs to be pulled HI externally through a resistor. This signal goes LO for any failure that requires power supply replacement. These faults may be due to:

- Fan failure
- Over-temperature shutdown
- Over-voltage shutdown
- Internal Fault

**Over temp warning (OTW#):** Omitted.

### Serial Bus Communications

The I<sup>2</sup>C interface facilitates the monitoring and control of various operating parameters within the unit and transmits these on demand over an industry standard I<sup>2</sup>C Serial bus.

All signals are referenced to 'Logic\_GRD'.

**Pull-up resistors:** The clock, data, and Alert# lines do not have any internal pull-up resistors inside the power supply. The customer is responsible for ensuring that the transmission impedance of the communications lines complies with I<sup>2</sup>C and SMBus standards.

**Serial Clock (SCL):** The clock pulses on this line are generated by the host that initiates communications across the I<sup>2</sup>C Serial bus. This signal needs to be pulled HI externally through a resistor as necessary to ensure that rise and fall time timing and the maximum sink current is in compliance to the I<sup>2</sup>C /SMBus specifications.

**Serial Data (SDA):** This line is a bi-directional data line. This signal needs to be pulled HI externally through a resistor as necessary to ensure that rise and fall time timing and the maximum sink current is in compliance to the I<sup>2</sup>C /SMBus specifications.

### Digital Feature Descriptions

**PMBus™ compliance:** The power supply is fully compliant to the Power Management Bus (PMBus™) rev1.2 requirements. This Specification can be obtained from [www.pmbus.org](http://www.pmbus.org).

'Manufacturer Specific' commands are used to support additional instructions that are not in the PMBus™ specification.

All communication over the PMBus interface must support the Packet Error Checking (PEC) scheme. The PMBus master must generate the correct PEC byte for all transactions, and check the PEC byte returned by the power supply.

The Alert# response protocol (ARA) whereby the PMBus Master can inquire who activated the Alert# signal is also supported. This feature is described in more detail later on.

Non-volatile memory is used to store configuration settings. Not all settings programmed into the device are automatically saved into this non-volatile memory. Only those specifically identified as capable of being stored can be saved. (see the Table of Commands for which command parameters can be saved to non-volatile storage).

**Non-supported commands:** Non-supported commands are flagged by setting the appropriate STATUS bit and issuing an Alert# to the 'host' controller.

If a non-supported read is requested the power supply will return 0x00h for data.

**Data out-of-range:** The power supply validates data settings and sets the data out-of-range bit and Alert# if the data is not within acceptable range.

## CP3500AC65TEZ High Efficiency Power Supply

Input: 100-240 Vac; 3500W capable; 65 Vdc @ 3500W; 5 Vdc @ 10W

**Master/Slave:** The ‘host controller’ is always the MASTER. Power Supplies are always SLAVES. SLAVES cannot initiate communications or toggle the Clock. SLAVES also must respond expeditiously at the command of the MASTER as required by the clock pulses generated by the MASTER.

**Clock stretching:** The ‘slave’  $\mu$ Controller inside the power supply may initiate clock stretching if it is busy and it desires to delay the initiation of any further communications. During the clock stretch the ‘slave’ may keep the clock LO until it is ready to receive further instructions from the host controller. The maximum clock stretch interval is 25ms.

The host controller needs to recognize this clock stretching, and refrain from issuing the next clock signal, until the clock line is released, or it needs to delay the next clock pulse beyond the clock stretch interval of the power supply. Note that clock stretching can only be performed after completion of transmission of the 9<sup>th</sup> ACK bit, the exception being the START command.

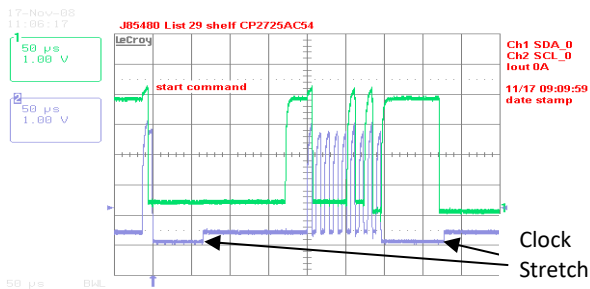

Figure 15. Example waveforms showing clock stretching.

**I<sup>2</sup>C Bus Lock-Up detection:** The device will abort any transaction and drop off the bus if it detects the bus being held low for more than 35ms.

**Communications speed:** Both 100kHz and 400kHz clock rates are supported. The power supplies default to the 100kHz clock rate.

**Packet Error Checking (PEC):** The power supply will not respond to commands without the trailing PEC. The integrity of communications is compromised if packet error correction is not employed. There are many functional features, including turning OFF the main output, that require validation to ensure that the desired command is executed.

PEC is a CRC-8 error-checking byte, based on the polynomial  $C(x) = x^8 + x^2 + x + 1$ , in compliance with PMBus™ requirements. The calculation is based in all message bytes, including the originating write address and command bytes preceding read instructions. The PEC is appended to the message by the device that supplied the last byte.

**Alert#:** The power supply can issue Alert# driven from either its internal micro controller ( $\mu$ C) or from the I<sup>2</sup>C bus master.

The  $\mu$ C driven Alert# signal informs the ‘master/host’ controller that either a STATE or ALARM change has occurred.

Normally this signal is HI. The signal will change to its LO level if the power supply has changed states and the signal will be latched LO until the power supply receives a ‘clear\_faults’ instruction.

The signal will be triggered for any state change, including the following conditions;

- VIN under or over voltage
- Vout under or over voltage
- IOOUT over current
- Over Temperature warning or fault
- Fan Failure
- Communication error
- PEC error
- Invalid command
- Internal faults
- Alert# is asserted during power up to notify the master that a new power supply has been added to the bus.

The power supply will clear the Alert# signal (release the signal to its HI state) upon the following events:

- Receiving a CLEAR\_FAULTS command
- Bias power to the processor is recycled

The power supply will re-assert the Alert line if the internal state of the power supply has changed, even if that information cannot be reported by the status registers until a clear\_faults is issued by the host. If the Alert asserts, the host should respond by issuing a clear\_faults to retire the alert line (this action also provides the ability to change the status registers). This action triggers another Alert assertion because the status registers changed states to report the latest state of the power supply. The host is now able to read the latest reported status register information and issue a clear\_faults to retire the Alert signal.

**Re-initialization:** The I<sup>2</sup>C code is programmed to re-initialize if no activity is detected on the bus for 5 seconds. Re-initialization is designed to guarantee that the I<sup>2</sup>C  $\mu$ Controller does not hang up the bus. Although this rate is longer than the timing requirements specified in the SMBus specification, it had to be extended in order to ensure that a re-initialization would not occur under normal transmission rates. During the few  $\mu$ seconds required to accomplish re-initialization the I<sup>2</sup>C  $\mu$ Controller may not recognize a command sent to it. (i.e. a start condition).

**Read back delay:** The power supply issues the Alert# notification as soon as the first state change occurred. During an event, a number of different states can be transitioned to before the final event occurs. If a read back is implemented rapidly by the host a successive Alert# could be triggered by the transitioning state of the power supply. In order to avoid successive Alert# s and read back and also to avoid reading a transitioning state, it is prudent to wait more than 2 seconds after the receipt of an Alert# before executing a read back. This delay will ensure that only the final state of the power supply is captured.

# CP3500AC65TEZ High Efficiency Power Supply

Input: 100-240 Vac; 3500W capable; 65 Vdc @ 3500W; 5 Vdc @ 10W

**Successive read backs:** Successive read backs to the power supply should not be attempted at intervals faster than every one second. This time interval is sufficient for the internal processors to update their data base so that successive reads provide fresh data.

**One bus:** This power supply has one i2c bus.

## PMBus™ Commands

**Standard instruction:** Up to two bytes of data may follow an instruction depending on the required data content. Analog data is always transmitted as LSB followed by MSB. PEC is mandatory and includes the address and data fields.

1	8	1	8	1
S	Slave address	Wr	A	Command Code

8	1	8	1	8	1	1
Low data byte	A	High data byte	A	PEC	A	P

Master to Slave      Slave to Master  
 SMBUS annotations; S – Start, Wr – Write, Sr – re-Start, Rd – Read, A – Acknowledge, NA – not-acknowledged, P – Stop

**Standard READ:** Up to two bytes of data may follow a READ request depending on the required data content. Analog data is always transmitted as LSB followed by MSB. PEC is mandatory and includes the address and data fields.

1	7	1	1	8	1
S	Slave address	Wr	A	Command Code	A

1	7	1	1	8	1
Sr	Slave Address	Rd	A	LSB	A

8	1	8	1	1
MSB	A	PEC	NA	P

**Block communications:** When writing or reading more than two bytes of data at a time BLOCK instructions for WRITE and READ commands are used instead of the Standard Instructions above to write or read any number of bytes greater than two.

Block write format:

1	7	1	1	8	1
S	Slave address	Wr	A	Command Code	A

8	1	8	1	8	1
Byte count = N	A	Data 1	A	Data 2	A

8	1	8	1	8	1	1
.....	A	Data N	A	PEC	A	P

Block read format:

1	7	1	1	8	1
S	Slave address	Wr	A	Command Code	A

1	7	1	1
Sr	Slave Address	Rd	A

8	1	8	1	8	1
Byte count = N	A	Data 1	A	Data 2	A

8	1	8	1	8	1	1
.....	A	Data N	A	PEC	NA	P

**Linear Data Format:** The definition is identical to Part II of the PMBus Specification. All standard PMBus values, with the exception of output voltage related functions, are represented by the linear format described below. Output voltage functions are represented by a 16 bit mantissa. Output voltage has a E=-9 constant exponent.

The Linear Data Format is a two byte value with an 11-bit, two's complement mantissa and a 5-bit, two's complement exponent or scaling factor, its format is shown below.

Data Byte High										Data Byte Low									
Bit	7	6	5	4	3	2	1	0	7	6	5	4	3	2	1	0			
	Exponent (E)					Mantissa (M)													

The relationship between the Mantissa, Exponent, and Actual Value (V) is given by the following equation:

$$V = M * 2^E$$

Where: V is the value, M is the 11-bit, two's complement mantissa, E is the 5-bit, two's complement exponent

## Standard features

**Supported features that are not readable:** The commands below are supported at the described setting but they cannot be read back through the command set.

Command	Comments
ON_OFF_CONFIG (0x02)	Both the CNTL pin, and the OPERATION command, enabling or disabling the output, are supported. Other options are not supported.
Capability (0x19)	400KHz, ALERT#
PMBus revision (0x98)	1.2

**Status and Alarm registers:** The registers are updated with the latest operational state of the power supply. For example, whether the output is ON or OFF is continuously updated with the latest state of the power supply. However, alarm information is maintained until a clear\_faults command is received from the host. For example, the shutdown or OC\_fault bits stay in their alarmed state until the host clears the registers.

A clear\_faults clears all registers. If a fault persists after the clear\_faults is commanded, the register bit annunciating the fault is reset again.

## CP3500AC65TEZ High Efficiency Power Supply

Input: 100-240 Vac; 3500W capable; 65 Vdc @ 3500W; 5 Vdc @ 10W

## PMBus™ Command set:

Command	Hex Code	Data Field	Memory Storage <sup>17</sup> / Default
Operation	0x01	1	Yes/80
Clear_Faults	0x03	-	
Write_Protect	0x10	1	Yes/00
Restore_default_all	0x12	-	
Restore_user_all	0x16	-	
Store_user_code	0x17	1	yes
Restore_user_code	0x18	1	
Vout_mode	0x20	1	
Vout_command	0x21	2	Yes/23
Vin_ON	0x35	2	
Vin_OFF	0x36	2	
Fan_config_1_2	0x3A	1	Yes /99
Fan_command_1	0x3B	2	
Vout_OV_fault_limit	0x40	2	Yes / 68
Vout_OV_fault_response	0x41	1	No / 80
Vout_OV_warn_limit	0x42	2	Yes / 66
Vout_UV_warn_limit	0x43	2	Yes / 21
Vout_UV_fault_limit	0x44	2	Yes /21
Vout_UV_fault_response	0x45	1	No / C0
lout_OC_fault_limit	0x46	2	Yes / 60

Command	Hex Code	Data Field	Memory Storage/ Default
lout_OC_fault_response <sup>18</sup>	0x47	1	Yes / F8
lout_OC_LV_fault_limit	0x48	2	Yes/21
lout_OC_warn_limit	0x4A	2	Yes / 59.4
OT_fault_limit	0x4F	2	Yes/115
OT_fault_response <sup>19</sup>	0x50	1	Yes / C0
OT_warn_limit	0x51	2	Yes/110
Vin_OV_fault_limit	0x55	2	No/ 270
Vin_OV_fault_response	0x56	1	No/ C0
Vin_OV_warn_limit	0x57	2	Yes / 265

<sup>17</sup> Yes – indicates that the data can be changed by the user<sup>18</sup> Only latched (0xC0) or hiccup (0xF8) are supported

Vin_UV_warn_limit <sup>20</sup>	0x58	2	Yes / 87.5
Vin_UV_fault_limit <sup>21</sup>	0x59	2	No / 80
Vin_UV_fault_response	0x5A	1	No/ C0
Status_byte	0x78	1	
Status_word (+ byte)	0x79	1	
Status_Vout	0x7A	1	
Status_lout	0x7B	1	
Status_Input	0x7C	1	
Status_temperature	0x7D	1	
Status_CML	0x7E	1	
Status_fans_1_2	0x81	1	
Read_Vin	0x88	2	
Read_lin	0x89	2	
Read_Vout	0x8B	2	
Read_lout	0x8C	2	
Read_temp_PFC	0x8D	2	
Read_temp_dc_pri	0x8E	2	
Read_temp_dc_sec	0x8F	2	
Read_fan_speed_1	0x90	2	
Read_fan_speed_2	0x91	2	
Read_Pin	0x97	2	
Mfr_ID	0x99	6	
Mfr_model	0x9A	16	
Mfr_revision	0x9B	8	
Mfr_serial	0x9E	16	
Status_summary	0xD0	12	
Status_unit	0xD1	2	
Status_alarm	0xD2	4	
Read_fan_speed	0xD3	7	
Read_input	0xD4	5	
Read_firmware_rev	0xD5	7	
Read_run_timer	0xD6	4	
EEPROM Record – section A	0xD9	≤32	yes
Read_temp_exhaust	0xDA	2	
Read_temp_inlet	0xDB	2	

Command	Hex Code	Data Field	Memory Storage/ Default
Reserved for factory use	0XDC		
Reserved for factory use	0XDD		
Reserved for factory use	0XDE		
Test_Function	0XDF	1	
<b>Upgrade commands</b>			
Password	0xE0	4	
Target_list	0xE1	4	

<sup>19</sup> Only latched (0x80) or restart (0xC0) are supported<sup>20</sup> Recovery set at 60V<sup>21</sup> Recovery set at 56V

# CP3500AC65TEZ High Efficiency Power Supply

Input: 100-240 Vac; 3500W capable; 65 Vdc @ 3500W; 5 Vdc @ 10W

Compatibility_code	0xE2	32	
Software_version	0xE3	7	
Memory_capability	0xE4	7	
Application_status	0xE5	1	
Boot_loader	0xE6	1	
Data_transfer	0xE7	≤32	
Product comcode	0xE8	11	
Upload_black_box	0xF0	≤32	
EEPROM Record – section B	0xF4	≤32	yes

**Clear\_faults (0x03):** Clears all STATUS and FAULT registers and resets the Alert# line. This command is always executable.

If a fault persists after the issuance of the clear\_faults command, the specific registers indicating the fault first clears but then get set again to indicate that the unit is still in the fault state.

**WRITE\_PROTECT register (0x10):** Used to control writing to the PMBus device. The intent of this command is to provide protection against accidental changes. All supported commands may have their parameters read, regardless of the write\_protect settings. The contents of this register cannot be stored into non-volatile memory using the Store\_user\_code command. The default setting of this register is enable\_all\_writes, write\_protect 0x00h. The write\_protect command must always be accepted.

## Command set adjustment range

If a command is received for a value setting that is outside the range defined below, the power supply should not change the present setting. The module sets the invalid/unsupported data bit of the status\_cml (0x7E) register.

Command	Hex Code	Default	Adjustment range	
		HL (LL)	Low	High
Vout_command	0x21	23	23	65
Fan_command_1	0x3B	-	0	100
Vout_OV_fault_limit	0x40	68	30	68
Vout_OV_warn_limit	0x42	66	25	66
Vout_UV_warn_limit	0x43	21	21	65
Vout_UV_fault_limit	0x44	21	21	65
Iout_OC_fault_limit	0x46	60	0	60
Iout_OC_LV_fault_limit	0x48	21	21	65
Iout_OC_warn_limit	0x4A	59.4	0	59.4
OT_fault_limit	0x4F	115	0	150
OT_warn_limit	0x51	110	0	150
Vin_OV_fault_limit	0x55	270	90	270
Vin_OV_warn_limit	0x57	265	90	265
Vin_UV_warn_limit	0x58	87.5	87.5	265
Vin_UV_fault_limit	0x59	80	80	265

## Command Descriptions

**Operation (0x01):** Turns the 65V output ON or OFF. The default state is **ON** at power up. Only the following data bytes are supported:

FUNCTION	DATA BYTE
Unit ON	0x80
Unit OFF	0x00

To **RESET** the power supply using this command, command the power supply OFF, wait at least 2 seconds, and then command the power supply back ON. All alarms and shutdowns are cleared during a restart.

FUNCTION	DATA BYTE
Enable all writes	00
Disable all writes except write_protect	80
Disable all writes except write_protect and OPERATION	40

**Restore\_Default\_All (0x12):** Restores all operating register values and responses to the factory default parameters set in the power supply. The factory default cannot be changed.

**Restore\_default\_code (0x14):** Restore only a specific register parameter into the operating register section of the power supply.

**Store\_user\_code (0x17):** Changes the user default setting of a single register. In this way, some protection is offered to ensure that only those registers that are desired to be changed are in fact changed.

**Restore\_user\_code (0x18):** Restores the user default setting of a single register.

**Vout\_mode (0x20):** This is a 'read only' register. The upper three bits specify the supported data format, in this case Linear mode. The lower five bits specify the exponent of the data in two's complement binary format for output voltage related commands, such as Vout\_command. These commands have a 16 bit mantissa. The exponent is fixed by the power supply and is returned by this command

Mode	Bits [7:5]	Bits [4:0] (Parameter)
Linear	000b	xxxxxb

**Vout\_Command (0x21) :** Used to dynamically change the output voltage of the power supply. This command can also be used to change the factory programmed default set point of the power by executing a store-user instruction that changes the user default firmware set point.

## CP3500AC65TEZ High Efficiency Power Supply

Input: 100-240 Vac; 3500W capable; 65 Vdc @ 3500W; 5 Vdc @ 10W

The default set point can be overridden by the Vprog signal pin which is designed to override the firmware based default setting during turn ON.

In parallel operation, changing the output voltage should be performed simultaneously to all power supplies using the Global Address (Broadcast) feature. If only a single power supply is instructed to change its output, it may attempt to source all the required power which can cause either a power limit or shutdown condition.

Software programming of output voltage permanently overrides the set point voltage configured by the Vprog signal pin. The power supply no longer looks at the 'Vprog pin' and will not respond to any hardware voltage settings. If power is removed from the  $\mu$ Controller it will reset itself into its default configuration looking at the Vprog signal for output voltage control. In many applications, the Vprog pin is used for setting initial conditions, if different than the factory setting. Software programming then takes over once I<sup>2</sup>C communications are established.

To properly hot-plug a power supply into a live backplane, the system generated voltage should get re-configured into either the factory adjusted firmware level or the voltage level reconfigured by the Vprog pin. Otherwise, the voltage state of the plugged-in power supply could be significantly different than the powered system.

Programmed voltage range: 23V<sub>DC</sub> – 65V<sub>DC</sub>.

**A voltage programming example:** The task: set the output voltage to 65.0V<sub>DC</sub>

This power supply supports the linear mode of conversion specified in the PMBus™ specification. The supported output voltage exponent is documented in the Vout\_mode (0x20) command. The exponent for output voltage setting is 2<sup>-9</sup> (see the PMBus™ specification for reading this command). Calculate the required voltage setting to be sent; 65 x 2<sup>9</sup> = 33280. Convert this decimal number into its hex equivalent: 8200 and send it across the bus LSB first and then MSB; E664 with the trailing PEC.

**Vin\_ON (0x35):** This is a 'read only' register that informs the controller at what input voltage level the power supply turns ON. The default value is tabulated in the data section. The value is contingent on whether the power supply is operating in the low\_line or high\_line mode.

**Vin\_OFF (0x36):** This is a 'read only' register that informs the controller at what input voltage level the power supply turns OFF. The default value is tabulated in the data section. The value is contingent on whether the power supply is operating in the low\_line or high\_line mode.

**Fan\_config\_1\_2 (0x3A):** This command requires that the fan speed be commanded by duty cycle. Both fans must be commanded simultaneously. The tachometer pulses per revolution is not used. Default is duty cycle control.

**Fan\_command\_1 (0x3B):** This command instructs the power supply to increase the speed of both fans above what is internally required. The transmitted data byte represents the hex equivalent of duty cycle in percentage, i.e. 100% = 0 x 64h. The command can increase or decrease fan speed. An incorrect value will result in a 'data error'.

Sending 00h tells the power supply to revert to its internal control.

**Vout\_OV\_fault\_limit (0x40):** Sets the value at which the main output voltage will shut down. This level can be permanently changed and stored in non-volatile memory.

**Vout\_OV\_fault\_response (0x41):** This is a 'read only' register. The only allowable state is a latched state after three retry attempts.

An overvoltage shutdown is followed by three attempted restarts, each successive restart delayed 1 second. If within a 1 minute window, three attempted restarts failed, the unit will latch OFF. If less than 3 shutdowns occur within the 1 minute window then the count for latch OFF resets and the 1 minute window starts all over again. This performance cannot be changed.

**Restart after a latched state:** Either of four restart mechanisms is available;

- The hardware pin **ON/OFF** may be cycled OFF and then ON.
- The unit may be commanded to restart via i2c through the *Operation* command by first turning OFF then turning ON.
- The third way to restart is to remove and reinsert the unit.
- The fourth way is to turn OFF and then turn ON AC power to the unit.

A successful restart clears all STATUS and ALARM registers.

A power system that is comprised of a number of power supplies could have difficulty restarting after a shutdown event because of the non-synchronized behavior of the individual power supplies. Implementing the latch-off mechanism permits a synchronized restart that guarantees the simultaneous restart of the entire system.

A synchronous restart can be implemented by;

- Issuing a GLOBAL OFF and then a GLOBAL ON command to all power supplies
- Toggling Off and then ON the **ON/OFF** signal, if this signal is paralleled among the power supplies.
- Removing and reapplying input power to the entire system.

The power supplies should be OFF for at least 20 – 30 seconds in order to discharge all internal bias supplies and reset the soft start circuitry of the individual units.

**Vout\_OV\_warn\_limit (0x42):** Sets the value at which a warning will be issued that the output voltage is too high. Exceeding the warning value will set the Alert# signal.

## CP3500AC65TEZ High Efficiency Power Supply

Input: 100-240 Vac; 3500W capable; 65 Vdc @ 3500W; 5 Vdc @ 10W

**Vout\_UV\_warn\_limit (0x43):** Sets the value at which a warning will be issued that the output voltage is too low. Reduction below the warning value will set the Alert# signal.

**Vout\_UV\_fault\_limit (0x44):** Sets the value at which the power supply will shut down if the output gets below this level. This register is masked if the UV is caused by interruption of the input voltage to the power supply.

**Vout\_UV\_fault\_response (0x45):** Sets the response if the output voltage falls below the UV\_fault\_limit. The default UV\_fault\_response is restart (0xC0). The only two allowable states are latched (0x80) and restart (0xC0).

**Iout\_OC\_fault\_limit (0x46):** Sets the value at which the power supply will shut down. The default OC\_fault\_limit is 60A. This level can be permanently changed and stored in non-volatile memory. And this parameter is only effective in high line. It is useless in lowline condition.

The Low Line level is not adjustable, it is set at 30A.

**Iout\_OC\_fault\_response (0x47):** Sets the response if the output overload exceeds the OC\_fault\_limit value. The default OC\_fault\_response is hiccup (0xF8). The only two allowable states are latched (0xC0) or hiccup. The response is the same for both low\_line and high\_line operations.

**Iout\_OC\_warn\_limit (0x4A):** Sets the value at which the power supply issues a warning that the output current is getting too close to the shutdown level at high line.

**OT\_fault\_limit (0x4F):** Sets the value at which the power supply responds to an OT event, sensed by the “dc-secondary” sensor. The response is defined by the OT\_fault\_response register.

**OT\_fault\_response (0x50):** Sets the response if the output overtemperature exceeds the OT\_fault\_limit value. The default OT\_fault\_response is hiccup (0xC0). The only two allowable states are latched (0x80) or hiccup.

**OT\_warn\_limit (0x51):** Sets the value at which the power supply issues a warning when the “dc-secondary” temperature sensor exceeds the warn limit.

**Vin\_OV\_fault\_limit (0x55):** Sets the value at which the power supply shuts down because the input voltage exceeds the allowable operational limit. The default Vin\_OV\_fault\_limit is set at 300Vac.

**Vin\_OV\_fault\_response (0x56):** Sets the response if the input voltage level exceeds the Vin\_OV\_fault\_limit value. The default Vin\_OV\_fault\_response is restart (0xC0). The only two allowable states are latched (0x80) and restart (0xC0).

**Vin\_UV\_warn\_limit (0x58):** This is a warning flag indicating that the input voltage is decreasing dangerously close to the low input voltage shutdown level.

**Vin\_UV\_fault\_limit (0x59):** Sets the value at which the power supply shuts down because the input voltage falls below the allowable operational limit.

**Vin\_UV\_fault\_response (0x5A):** Sets the response if the input voltage level falls below the Vin\_UV\_fault\_limit value. The default Vin\_UV\_fault\_response is restart (0xC0). The only two allowable states are latched (0x80) and restart (0xC0).

**STATUS\_BYTE (0x78):** Returns one byte of information with a summary of the most critical device faults.

Bit Position	Flag	Default Value
7	Unit is busy	0
6	OUTPUT OFF	0
5	VOUT Overvoltage Fault	0
4	IOUT Overcurrent Fault	0
3	VIN Undervoltage Fault	0
2	Temperature Fault or Warning	0
1	CML (Comm. Memory Fault)	0
0	None of the above	0

**STATUS\_WORD (0x79):** Returns status\_byte as the low byte and the following high\_byte.

Bit Position	Flag	Default Value
7	VOUT Fault or Warning	0
6	IOUT Fault or Warning	0
5	INPUT Fault or Warning	0
4	MFR SPECIFIC	0
3	POWER_GOOD# (is negated)	0
2	FAN Fault or Warning	0
1	OTHER	0
0	UNKNOWN Fault or Warning	0

**STATUS\_VOUT (0x7A):** Returns one byte of information of output voltage related faults.

Bit Position	Flag	Default Value
7	VOUT OV Fault	0
6	VOUT_OV_WARNING	0
5	VOUT_UV_WARNING	0
4	VOUT UV Fault	0
3 - 0	X	0

**STATUS\_IOUT (0x7B):** Returns one byte of information of output current related faults.

Bit Position	Flag	Default Value
7	IOUT OC Fault	0
6	IOUT OC LV Fault	0
5	IOUT OC Warning	0

# CP3500AC65TEZ High Efficiency Power Supply

Input: 100-240 Vac; 3500W capable; 65 Vdc @ 3500W; 5 Vdc @ 10W

4	X	0
3	CURRENT SHARE Fault	0
2	IN POWER LIMITING MODE	0
1-0	X	0

**STATUS\_INPUT (0X7C):** Returns one byte of information of input voltage related faults.

Bit Position	Flag	Default Value
7	VIN_OV_Fault	0
6	VIN_OV_Warning	0
5	VIN_UV_Warning	0
4	VIN_UV_Fault	0
3	Unit OFF for low input voltage	0
2	IIN_OC_Fault	0
1-0	X	0

**STATUS\_TEMPERATURE (0x7D):** Returns one byte of information of temperature related faults.

Bit Position	Flag	Default Value
7	OT Fault	0
6	OT Warning	0
5-0	X	0

**STATUS\_CML (0X7E):** Returns one byte of information of communication related faults.

Bit Position	Flag	Default Value
7	Invalid/Unsupported Command	0
6	Invalid/Unsupported Data	0
5	Packet Error Check Failed	0
4-2	X	0
1	Other Communication Fault	0
0	X	0

**STATUS\_fans\_1\_2 (0X81):** Returns one byte of information of fan status.

Bit Position	Flag	Default Value
7	Fan 1 fault	0
6	Fan 2 fault	0
5-4	X	0
3-2	Fan 1 & 2 speed overwritten	0
1-0	X	0

## Read back Descriptions

**Single parameter read back:** Functions can be read back one at a time using the read\_word\_protocol with PEC. A command is first sent out notifying the slave what function is to be read back followed by the data transfer.

Analog data is always transmitted LSB followed by MSB. A NA following the PEC byte signifies that the transmission is complete and is being terminated by the 'host'.

1	8	1	8	1
S	Slave address	Wr	A	Command Code

1	8	1
Sr	Slave address	Rd

8	1	8	1	8	1	1
LSB	A	MSB	A	PEC	No-Ack	P

**Read back error:** If the µC does not have sufficient time to retrieve the requested data, it has the option to return all FF's instead of incorrect data.

**Read\_fan\_speed 1 & 2 (0x90, 0x91):** Reading the fan speed is in Direct Mode returning the RPM value of the fan.

**Read\_FRU\_ID (0x99,0x9A,0x9B,0x9E):** Returns FRU information. Must be executed one register at a time.

1	8	1	8	1
S	Slave address	Wr	A	Command 0x9x

1	8	1	8	1
Sr	Slave address	Rd	A	Byte count = x

8	1	8	1	8	1	8	1	1
Byte_1	A	Byte	A	Byte_x	A	PEC	No-Ack	P

**Mfr\_ID (0x99):** Manufacturer in ASCII – 6 characters maximum,

General Electric – Critical Power, represented as GE-CP

**Mfr\_model (0x9A):** Manufacturer model-number in ASCII – 16 characters, for this unit: CP3500AC65TEFBxx

**Mfr\_revision (0x9B):** Total 8 bytes, this is the product series taking the form X:YZ. Each byte is in ASCII format. The series number is read from left to right, scanned from the series number bar code on the power supply label. Unused characters are filled at the end with null

**Mfr\_serial (0x9E):** Product serial number includes the manufacturing date, manufacturing location in up to 16 characters. For example:

13KZ51018193xxxx, is decoded as;

13 – year of manufacture, 2013

KZ – manufacturing location, in this case Matamoros

51 – week of manufacture

018193xxxx– serial #, mfr choice



# CP3500AC65TEZ High Efficiency Power Supply

Input: 100-240 Vac; 3500W capable; 65 Vdc @ 3500W; 5 Vdc @ 10W

## Manufacturer-Specific PMBus™ Commands

Many of the manufacturer-specific commands read back more than two bytes. If more than two bytes of data are returned, the standard SMBus™ Block read is utilized. In this process, the Master issues a Write command followed by the data transfer from the power supply. The first byte of the Block Read data field sends back in hex format the number of data bytes, exclusive of the PEC number, that follows. Analog data is always transmitted LSB followed by MSB. A No-ack following the PEC byte signifies that the transmission is complete and is being terminated by the 'host'.

**Mfr\_Specific Status and alarm registers:** The content and partitioning of these registers is significantly different than the standard register set in the PMBus™ specification. More information is provided by these registers and they are either accessed rapidly, at once, using the 'multi parameter' read back scheme of this document, or in batches of two STATUS and two ALARM registers.

**Status\_summary (0xD0):** This 'manufacturer specific' command is the basic read back returning STATUS and ALARM register data, output voltage, output current, and internal temperature data in a single read. Internal temperature should return the temperature that is closest to a shutdown level.

1	8	1	8	1
S	Slave address	Wr	A	Command Code

1	8	1	8	1
Sr	Slave address	Rd	A	Byte count = 11

8	1	8	1	8	1	8	1
Status-2	A	Status-1	A	Alarm-3	A	Alarm-2	A

8	1	8	1	8	1
Alarm-1	A	Voltage LSB	A	Voltage MSB	A

8	1	8	1
Current-LSB	A	Current-MSB	A

8	1	8	1
Temperature-LSB	A	Temperature-MSB	A

8	1	1
PEC	No-Ack	P

**Status\_unit(0xD1):** This command returns the STATUS-2 and STATUS-1 register values using the standard 'read' format.

### Status-2

Bit Position	Flag	Default Value
7	PEC Error	0
6	OC [hiccup=1, latch=0]	1
5	Invalid_Instruction	0
4		x
3	OR'ing Test Failed	0
2	n/a	0
1	Data_out_of_range	0
0	Remote ON/OFF [HI = 1]	x

**Oring fault:** Triggered either by the host driven or'ing test or by the repetitive testing of this feature within the power supply. A destructive fault would cause an internal shutdown. Success of the host driven test depends on power capacity capability which needs to be determined by the external processor. Thus, a non-destructive or'ing fault does not trigger a shutdown.

### Status-1

Bit Position	Flag	Default Value
7	OT [Hiccup=1, latch=0]	1
6	OR'ing_Test_OK	0
5	Internal_Fault	0
4	Shutdown	0
3	Service LED ON	0
2	External_Fault	0
1	LEDs_Test_ON	0
0	Output ON (ON = 1)	x

**Status\_alarm (0xD2):** This command returns the ALARM-3 - ALARM-1 register values.

### Alarm-3

Bit Position	Flag	Default Value
7	Interlock open	0
6	Fuse fail	0
5	PFC-DC communications fault	0
4	DC-i2c communications fault	0
3	AC monitor communications fault	0
2	x	0
1	x	0
0	Or'ing fault	0

### Alarm-2

Bit Position	Flag	Default Value
7	FAN_Fault	0
6	No_Primary	0
5	Primary_OT	0
4	DC/DC_OT	0
3	Vo lower than BUS	0
2	Thermal sensor failed	0
1	Stby_out_of_limits	0
0	Power_Delivery	0

**Power Delivery:** If the internal sourced current to the current share current is > 7A, a fault is issued.

### Alarm-1

Bit Position	Flag	Default Value
7	POWER LIMIT	0
6	PRIMARY Fault	0
5	OT_Shutdown	0
4	OT_Warning	0
3	IN OVERCURRENT	0

# CP3500AC65TEZ High Efficiency Power Supply

Input: 100-240 Vac; 3500W capable; 65 Vdc @ 3500W; 5 Vdc @ 10W

2	OV_Shutdown	0
1	VOUT_out_of_limits	0
0	VIN_out_of_limits	0

**Read\_Fan\_speed (0 x D3):** Returns the commanded speed in percent and the measured speed in RPM. If a fan does not exist, or if the command is not supported the unit return 0x00.

1	8	1	8	1
S	Slave address	Wr	A	Command 0xE1

1	8	1	8	1
Sr	Slave address	Rd	A	Byte count = 6

8	1	8	1	8	1	8	1
Adj%-LSB	A	Adj%-MSB	A	Fan1-LSB	A	Fan1-MSB	A

8	1	8	1	8	1	1
Fan2-LSB	A	Fan2-MSB	A	PEC	No-Ack	P

**Read input string (0xD4):** Reads back the input voltage and input power consumed by the power supply.

1	7	1	1	8
S	Slave address	Wr	A	Command Code 0xDC

1	1	7	1	1
A	Sr	Slave Address	Rd	A

8	1	8	1	8	1
Byte Count = 4	A	Voltage - LSB	A	Voltage - MSB	A

8	1	8	1	8	1	1
Power - LSB	A	Power - MSB	A	PEC	No-Ack	P

**Read\_firmware\_rev [0 x D5]:** Reads back the firmware revision of all three micro-controllers in the power supply.

1	7	1	1	8	1
S	Slave address	Wr	A	Command Code 0xDD	A

1	1	7	1	1	8	1
A	Sr	Slave Address	Rd	A	Byte Count = 6	A

8	1	8	1
Primary major rev	A	Primary minor rev	A

8	1	8	1
Secondary major rev	A	Secondary minor rev	A

8	1	8	1	8	1	1
i2c major rev	A	i2c revision	A	PEC	No-ack	P

**Read\_run\_timer [0 x D6]:** This command reads back the recorded operational ON state of the power supply in hours. The operational ON state is accumulated from the time the power supply is initially programmed at the factory. The power supply is in the operational ON state both when in standby and when it delivers main output power.

Recorded capacity is approximately 10 years of operational state.

1	7	1	1	8	1
S	Slave address	Wr	A	Command Code 0xDE	A

1	7	1	1	8	1
Sr	Slave Address	Rd	A	Byte count = 3	A

8	1	8	1	8	1
Time - LSB	A	Time	A	Time - MSB	A

8	1	1
PEC	No-ack	P

**EEPROM record:** The  $\mu$ C contains 64 bytes of reserved EEPROM space for customer use. Command (0xD9) is used to store/retrieve into the lower 32 bytes of the memory space and command (0xF4) is used to store/retrieve into the upper 32 bytes of the memory space.

To store contents into the EEPROM space;

1	7	1	1	8	1
S	Slave address	Wr	A	Command Code 0xD9 or 0xF4	A

8	1
Byte count	A

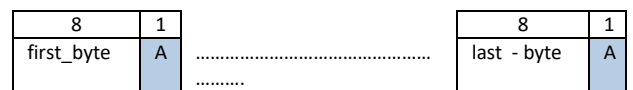

8	1	1
PEC	A	P

To read contents from the EEPROM space

1	7	1	1	8	1
S	Slave address	Wr	A	Command 0xD9 or 0xF4	A

1	7	1	1	8	1
Sr	Slave address	Rd	A	Byte count $\leq$ 32	A

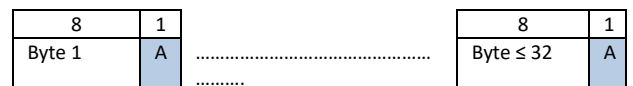

8	1	1
PEC	No-ack	P

### Test Function (0xDF)

Bit	Function	State
7	25ms stretch for factory use	1= stretch ON
5 - 6	reserved	
4	Or'ing test	1=ON, 0=OFF
2 - 3	reserved	
1	Service LED	1=ON, 0=OFF
0	LED test	1=ON, 0=OFF

## CP3500AC65TEZ High Efficiency Power Supply

Input: 100-240 Vac; 3500W capable; 65 Vdc @ 3500W; 5 Vdc @ 10W

**LEDs test ON:** Will turn-ON simultaneously the front panel LEDs of the power supply sequentially 7 seconds ON and 2 seconds OFF until instructed to turn OFF. The intent of this function is to provide visual identification of the power supply being talked to and to visually verify that the LEDs operate and driven properly by the micro controller.

**LEDs test OFF:** Will end the LED test, and cause them to revert to normal status indications.

**Service LED ON:** Requests the power supply to *flash*-ON the Service (ok-to-remove) LED. The *flash* sequence is approximately 0.5 seconds ON and 0.5 seconds OFF.

**Service LED OFF:** Requests the power supply to turn OFF the Service (ok-to-remove) LED.

**OR'ing Test:** This command verifies functioning of output OR'ing. At least two paralleled power supplies are required. The host should verify that N+1 redundancy is established. If N+1 redundancy is not established the test can fail. Only one power supply should be tested at a time.

Verifying test completion should be delayed for approximately 30 seconds to allow the power supply sufficient time to properly execute the test.

Failure of the isolation test is not considered a power supply FAULT because the N+1 redundancy requirement cannot be verified. The user must determine whether a true isolation fault indeed exists.

### Single Master Control:

One I<sup>2</sup>C clock, data, and Alert# signal provides communications.

### General performance descriptions

**Default state:** Power supplies are programmed in the default state to automatically restart after a shutdown has occurred. The default state can be reconfigured by changing non-volatile memory (Store\_user\_code).

**Delayed overcurrent shutdown during startup:** Power supplies are programmed to stay in a constant current state for up to 20 seconds during power up. This delay has been introduced to permit the orderly application of input power to a subset of paralleled power supplies during power up. If the overload persists beyond the 20 second delay, the power

supply will revert to its programmed state of overload protection.

**Unit in Power Limit or in Current Limit:** When output voltage is > 30V<sub>DC</sub> the Output LED will continue blinking. When output voltage is < 30V<sub>DC</sub>, if the unit is in the RESTART mode, it goes into hiccup after a 3 second delay. When the DC power is ON the output LED is ON, when the DC power is OFF the output LED is OFF.

When the unit is in latched shutdown the output LED is OFF.

**Restart after a latching:** PMBus™ fault\_response commands can be configured to direct the power supply to remain latched off for over\_voltage, over\_temperature and over\_current.

To restart after a latch off either of five restart mechanisms are available.

1. The hardware pin **ON/OFF** may be cycled OFF and then ON.
2. The unit may be commanded to restart via i2c through the *Operation* command by cycling the output OFF followed by ON.
3. Remove and reinsert the unit.
4. Turn OFF and then turn ON AC power to the unit.
5. Changing firmware from **latch off** to **restart**.

Each of these commands must keep the power supply in the OFF state for at least 2 seconds, with the exception of changing to **restart**.

A successful restart shall clear all alarm registers, set the **restarted successful** bit of the **Status\_2** register.

A power system that is comprised of a number of power supplies could have difficulty restarting after a shutdown event because of the non-synchronized behavior of the individual power supplies. Implementing the latch-off mechanism permits a synchronized restart that guarantees the simultaneous restart of the entire system.

A synchronous restart can be implemented by;

1. Issuing a GLOBAL OFF and then ON command to all power supplies,
2. Toggling Off and then ON the ON/OFF (ENABLE) signal
3. Removing and reapplying input power to the entire system.

The power supplies should be turned OFF for at least 20 – 30 seconds in order to discharge all internal bias supplies and reset the soft start circuitry of the individual power supplies.

**Auto\_restart:** Auto-restart is the default configuration for over-current and over-temperature shutdowns. These features are configured by the PMBus™ fault\_response commands.

An overvoltage shutdown is followed by three attempted restarts, each restart delayed 1 second, within a 1 minute window. If within the 1 minute window three attempted restarts failed, the unit will latch OFF. If within the 1 minute

## CP3500AC65TEZ High Efficiency Power Supply

Input: 100-240 Vac; 3500W capable; 65 Vdc @ 3500W; 5 Vdc @ 10W

less than 3 shutdowns occurred then the count for latch OFF resets and the 1 minute window starts all over again

### Fault Management

The power supply recognizes that certain transitional states can occur before a final state is reached. The STATUS and ALARM registers will not be frozen into a notification state until the final state is reached. Once a final state is reached the Alert# signal is set and the STATUS and ALARM registers will not get reinstated until a clear\_faults is issued by the master. The only exception is that additional state changes may be added to the original list if further changes are noted.

The power supply differentiates between **internal faults** that are within the power supply and **external faults** that the power supply protects itself from, such as overload or input voltage out of limits. The FAULT LED, FAULT PIN or i2c alarm is not asserted for EXTERNAL FAULTS. Every attempt is made to announce External Faults. Some of these annunciations can be observed by looking at the input LEDs. These fault categorizations are predictive in nature and therefore there is a likelihood that a categorization may not have been made correctly.

**Input voltage out of range:** The Input LED will continue blinking as long as sufficient power is available to power the LED. If the input voltage is completely gone the Input LED is OFF.

### State Change Definition

A **state\_change** is an indication that an event has occurred that the MASTER should be aware of. The following events shall trigger a **state\_change**;

- Initial power-up of the system when AC gets turned ON. This is the indication from the power supply that it has been turned ON. Note that the master needs to read the status of each power supply to reset the system\_interrupt.
- Any changes in the bit pattern of either the PMBus standard STATUS or the mfr\_specific STATUS registers should trigger the Alert# signal.

### Hot plug procedures

Careful system control is recommended when hot plugging a power supply into a live system. It takes about 1 second for a power supply to configure its address on the bus based on the analog voltage levels present on the backplane. If communications are not stopped during this interval, multiple power supplies may respond to specific instructions because the address of the newly inserted power supply always defaults to xxxx000 until the power supply has configured its

address. The system can detect the hot-plug activity by polling the unit\_present signal pin.

The one exception for this instruction delay recommendation is execution of a 'global or broadcast' instruction to all power supplies simultaneously, which does not utilize the power supply's own address.

The recommended procedure for hot removal in controller based systems is the following: The system controller should signal the craft person which power supply is to be removed. This is suggested so that the correct power supply is removed by the craft person. The controller turns the service LED ON, thus informing the craft person that the identified power supply can be removed from the system. The system controller should then poll the rectifier\_present signal to verify when the power supply has been inserted. Once the insertion is detected, the system controller should time out for 1 second before sending out a non-'global or broadcast' address based instruction. . At the end of the time out all communications can resume.

The hot-plugged power supply will turn ON to the voltage level set by the  $V_{prog}$  pin. As described in the section on setting the  $V_{prog}$  pin, the system needs to set the output voltage to a level that would not cause harm or malfunction. For this power supply, the recommended output voltage setting would be 23Vdc. The power supply would stay at this level until a firmware instruction tells it to change its setting. For systems controlled via the  $V_{prog}$  pin (output controlled by hardware instead of firmware) no special settings or configurations are required.

### Failure Prediction

Alarm warnings that do not cause a shutdown are indicators of potential future failures of the power supply. For example, if a thermal sensor failed, a warning is issued but an immediate shutdown of the power supply is not warranted.

Another example of potential predictive failure mechanisms can be derived from information such as fan speed when multiple fans are used in the same power supply. If the speed of the fans varies by more than 20% from each other, this is an indication of an impending fan wear out.

The goal is to identify problems early before a protective shutdown would occur that would take the power supply out of service.

**Information only alarms:** The following alarms are for information only. They do not cause a shutdown

- Over temperature warning
- $V_{out}$  out-of-limits
- Output voltage lower than bus
- Unit in Power Limit
- Thermal sensor failed
- Or'ing (Isolation) test failure
- Power delivery
- Standby output out of limits
- Communication errors

# CP3500AC65TEZ High Efficiency Power Supply

Input: 100-240 Vac; 3500W capable; 65 Vdc @ 3500W; 5 Vdc @ 10W

## Remote upgrade

This section describes, at a high-level, the recommended re-programming process for the three internal micro controllers inside the power supply when the re-programming is implemented in live, running, systems.

The process has been implemented in visual basic by GE Critical Power for controller based systems. GE Critical Power will share its development with customers who are interested to deploy the re-programming capability into their own controllers.

For some customers, internal system re-programming is either not feasible or not desired. These customers may obtain a re-programming kit from GE Critical Power. This kit contains a turn-key package with the re-program firmware.

**Concept Description:** The power supply contains three independent  $\mu$ Controllers. The boost (PFC) section is controlled by the primary  $\mu$ Controller. The secondary DC-DC converter is controlled by the secondary  $\mu$ Controller, and I<sup>2</sup>C communications are being handled by the I<sup>2</sup>C Interface  $\mu$ Controller.

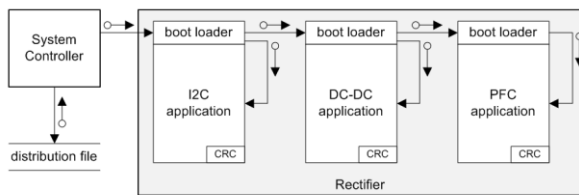

Each of the  $\mu$ Controllers contains a **boot loader** section and an **application** section in memory. The purpose of the boot loader section is to facilitate the upgrading capability described here. All the commands for upgrading and memory space required for incrementally changing the application code are in this section. The application section contains the running code of the power supply.

The system controller receives the upgrade package. It should first check whether an upgrade is required followed by upgrading those processors, one at a time, that are required to be upgraded. Each processor upgrade needs to be validated and once the upgrade is successfully completed the boot loader within each processor will permit the application to run after a reset. If the validation fails the boot loader will stay in its section. The system controller can attempt another upgrade session to see if it would complete successfully.

**The Upgrade Package:** This package contains the following files;

- **Manifest.txt** - The manifest describes the contents of the upgrade package and any incidental information that may be useful, for example, what this upgrade contains or why is this upgrade necessary. This file contains the version number

and the compatibility code of the upgraded program for each of the three processors

- **Program.bin** - The upgraded program contents are located here. Each processor to be upgraded will have its own file.

Below is an example of an upgrade package

- Contents of the upgrade are in a zip file CP3x00AC65TEZ.zip
- Unzipping the contents shows the following files  
CP3x00AC65TEZ.pfc.bin  
CP3x00AC65TEZ.sec.bin  
manifest.txt
- Opening manifest.txt shows the following  
# Upgrade manifest file  
# Targets: CP3x00AC65TEZ PFC and SEC  
# Date: Tue 01/14/2017 14:25:09.37  
# Notes:
- Program contents  
>p, CP3x00AC65TE\_P01, CP3x00AC65TEZ\_PFC.bin,1.18  
>s, CP3x00AC65TE\_S01, CP3x00AC65TEZ\_SEC.bin,1.1  
compatibility code, new program, revision number

**Upgrade Status Indication:** The FAULT LED is utilized for indicating the status of the re-programming process.

Status	Fault LED	Description
Idle	OFF	Normal state
In boot block	Wink	Application is good
Upgrading	Fast blink	Application is erased or programming in progress
Fault	ON	Erase or re-program failed

Wink: 0.25 seconds ON, 0.75 seconds OFF

Fast Blink: 0.25 seconds ON. 0.25 seconds OFF

## Upgrade procedure

1. Initialization: To execute the re-programming/upgrade in the system, the power supply to be re-programmed must first be taken OFF-line prior to executing the upgrade. If the power supply is not taken OFF-line by the system controller, the boot loader will turn OFF the output prior to continuing with the re-programming operation.

Note: Make sure that sufficient power is provided by the remaining on-line power supplies so that system functionality is not jeopardized.

2. Unzip the distribution file
3. Unlock upgrade execution protection by issuing the command below;

**Password(0xE0):** This command unlocks the upgrade commands feature of the power supply by sending the characters 'UPGD'.

# CP3500AC65TEZ High Efficiency Power Supply

Input: 100-240 Vac; 3500W capable; 65 Vdc @ 3500W; 5 Vdc @ 10W

1	8	1	8	1	8	1	
S	Slave addr	Wr	A	Cmd – 0xE0	A	Byte count - 4	A

8	1	8	1	8	1	1	
Byte 0 - U	A	.....	Byte 4 - D	A	PEC	A	P

4. Obtain a list of upgradable processors (optional)

**Target list(0xE1):** This command returns the upgradable processors within the power supply. The byte word is the ASCII character of the processor (p, s, and i). The command is optional to the user for information only.

1	8	1	8	1	
S	Slave addr	Wr	A	Cmd – 0xE1	A

1	8	1	8	1	
Sr	Slave addr	Rd	A	Byte count - n	A

8	1	8	1	8	1	1	
Byte 0	A	.....	Byte n	A	PEC	No-Ack	P

Potential target processors are the following:

- p – primary (PFC)
- s – secondary (DC-DC)
- i – I<sup>2</sup>C

5. Verify upgrade compatibility by matching the upgrade compatibility code in the manifest.txt file to the power supply compatibility code of the target processor.

**Compatibility code (0xE2):** This read command consists of up to 32 characters defining the hardware configuration:

1	8	1	8	1	8	1	
S	Slave addr	Wr	A	Cmd – 0xE2	A	Target-x	A

1	8	1	8	1	8	1	
Sr	Slave addr	Rd	A	Byte count = 32	A	Byte 0	A

.....	8	1	8	1	1
...	Byte 31	A	PEC	No-Ack	P

Where Target-x is an ASCII character pointing to the processor to be updated;

- p – primary (PFC)
- s – secondary (DC-DC)
- i – I<sup>2</sup>C

6. Check the software revision number of the target processor in the power supply and compare it to the revision in the upgrade. If the revision numbers are the same, or the power supply has a higher revision number then no upgrade is required for the target processor.

**Software revision(0xE3):** This command returns the software revision of the target.

1	8	1	8	1	8	1	
S	Slave addr	Wr	A	Cmd – 0xE3	A	Target-x	A

1	8	1	8	1	8	1	
Sr	Slave addr	Rd	A	Byte count=7	A	Major revision	A

8	1	8	1	8	1	8	1
Minor revision	A	month	A	day	A	year <sup>22</sup>	A

8	1	8	1	8	1	1
hrs	A	min	A	PEC	No-Ack	P

7. Verify the capability of each processor

**Memory capability (0xE4):** Provides the specifics of the capability of the device to be reprogrammed

1	8	1	8	1	8	1	
S	Slave addr	Wr	A	Cmd – 0xE2	A	Target-x	A

1	8	1	8	1	8	1	
Sr	Slave addr	Rd	A	Byte count=7	A	Max bytes	A

8	1	8	1	8	1	8	1
ET-LSB	A	ET-MSB	A	BT-LSB	A	BT-MSB	A

8	1	8	1	8	1	1
App_CRC_LSB	A	App_CRC_MSB	A	PEC	No-Ack	P

Where the fields definition is shown as below:

<b>Max Bytes</b>	Maximum number of bytes in a data packet
<b>ET</b>	Erase time for entire application space (in mS)
<b>BT</b>	Data packet write execution time (uS)
<b>APP_CRC</b>	Application CRC-16 – returns the application CRC-16 calculation. Reading these register values, if the application upload CRC-16 calculation returns an invalid, provides the mismatch information to the host program. (See application status(0xE5) command)

This information should be used by the host processor to determine the maximum data packet size and add appropriate delays between commands.

8. Verify availability: The Application status command is used to verify the present state of the boot loader.

**Application status (0xE5):** Returns the Boot Loader’s present status

<sup>22</sup> Last two digits

CP3500AC65TEZ High Efficiency Power Supply

Input: 100-240 Vac; 3500W capable; 65 Vdc @ 3500W; 5 Vdc @ 10W

1	8	1	8	1	8	1	
S	Slave addr	Wr	A	Cmd – 0xE5	A	Target-x	A

1	8	1	8	1	8	1	1	
Sr	Slave addr	Rd	A	Status	A	PEC	No-Ack	P

Status bits:

0x00	Processor is available	0x10	Reserved
0x01	Application erased	0x20	Reserved
0x02	CRC-16 invalid	0x40	Manages downstream $\mu$ C
0x04	Sequence out of order	0x80	In boot loader
0x08	Address out of range		

Status of the application should be checked after the execution of successive commands to verify that the commands have been properly executed.

- Issue a Boot Loader command with the *enter boot block* instruction

**Boot loader (0xE6):** This command manages the upgrade process starting with entering the sector, erasing the present application, indicating completion of the upload and finally exiting from the boot sector, thereby turning over control to the uploaded application.

1	7	7	7	8	1	8	1
S	Slave addr	Wr	A	Cmd – 0xE6	A	Target-x	A

8	1	8	1	1
Data	A	PEC	A	P

Data:

- 1=enter boot block (software reboot)
- 2=erase
- 3=done
- 4=exit<sup>23</sup> boot block (watchdog reboot)

**Note:** The target  $\mu$ C field is ignored for enter and exit commands. During this process if the output of the power supply was not turned OFF the boot loader will turn OFF the output

- Erase and program each  $\mu$ C using the Boot Loader command, starting with the PFC.
- Wait at least 1 second after issuing an *erase* command to allow the  $\mu$ C to complete its task.
- Use command 0xE5 to verify that the PFC  $\mu$ C is erased. The returned status byte should be 0x81.
- Use the Data Transfer command to update the application of the target  $\mu$ C.

**Data transfer (0xE7):** The process starts with uploading data packets with the first sequence number (0x0000).

1	8	1	8	1	8	1	
S	Slave addr	Wr	A	Cmd - 0xE7	A	Target-x	A

8	1	8	1	8	1
Seq-LSB	A	Seq-MSB	A	Byte Count = n	A

8	1	8	1	1			
Byte 0	A	.....	Byte n-1	A	PEC	A	P

After completion of the first data packet upload the Boot loader increments the sequence number. A subsequent read to the boot loader will return the incremented sequence number and a STATUS byte. This is a validity check to ensure that the sequence number is properly kept. The returned STATUS byte is the same as the application status response. It is appended here automatically to save the execution of another command. It should be checked to ensure that no errors are flagged by the boot loader during the download. If an error occurred, terminate the download load and attempt to reprogram again.

1	8	1	8	1	
S	Slave addr	Wr	A	Cmd - 0xE4	A

1	8	1	8	1	
Sr	Slave addr	Rd	A	Byte count = 3	A

1	8	8	1	8	1	8	1	1
Seq-LSB	A	Seq-MSB	A	Status	A	PEC	No-Ack	P

Sequence number validation takes place after each data block transfer. The next data block transfer starts with the sequence number received from the boot loader.

The host keeps track of the upload and knows when the upload is completed.

- Execute a Boot loader command to tell the PFC  $\mu$ C that the transfer is done.

At the completion signal, the PFC  $\mu$ C should calculate the PEC value of the entire application. The last two bytes of the loaded application were the CRC-16 based PEC calculation.

Wait for at least 1 second to allow time for the PFC  $\mu$ C to calculate the error checking value.

- Execute an Application status command to verify that the error check is valid. The returned status should be 0x80.

<sup>23</sup> The 'exit boot block' command is only successful if all applications are valid, otherwise, control remains in the boot block

# CP3500AC65TEZ High Efficiency Power Supply

Input: 100-240 Vac; 3500W capable; 65 Vdc @ 3500W; 5 Vdc @ 10W

16. Execute a Boot loader command to exit boot block. Upon receipt of the command the PFC  $\mu$ C will transfer to the uploaded application code.
17. Wait for at least 1 second.
18. Use command 0xE1 to verify that the PFC  $\mu$ C is now in the application code. The returned status data byte should be 0x00.
19. Repeat the program upgrade for the Secondary and I<sup>2</sup>C  $\mu$ C's, if included in the upgrade package.

## Product comcode

Although the comcode number is not required for the upgrade process in its present form, it may be useful when upgrading multiple versions of the same product in order to differentiate product upgrade requirements.

### Product comcode (0xE8):

1	8	1	8	1
S	Slave addr	Wr	A	Cmd - 0xE8

1	8	1	8	1
Sr	Slave addr	Rd	A	Byte count = 11

8	1	8	1	1
Byte 0	A	.....	Byte 10	A
			PEC	No-Ack
				P

**Error handling:** The Boot loader will not start the application if errors occurred during the re-program stage. The controlling program could restart the upgrade process or terminate the upgrade and remove the offending power supply from service.

## Black box

Contents of the black box and more detailed information about the specifics of the feature are described in a separate document. The intent here is to provide a high-level summary. This feature includes the following;

1. A rolling event Recorder
2. Operational Use Statistics

### The rolling event recorder

The purpose of the black box is to provide operational statistics as well as fault retention for diagnostics following either recoverable or non-recoverable fault events. Sufficient memory exists to store up to 5 time-stamped snapshot records (pages) that include the state of the status and alarm registers and numerous internal measurement points within the power supply. Each record is stored into nonvolatile memory at the time when a black box trigger event occurs. Once five records are stored, additional records over-write the oldest record.

The memory locations are cleared, when the product is shipped from the GE factory.

### Operational use statistics

This feature of the black box includes information on the repetition and duration of certain events in order to understand the long-term operational state of the power supply. The events are placed into defined buckets for further analysis. For example; the power supply records how long the output current was provided in certain load ranges.

### Accessing the event records

The event records are accessed by uploading the entire contents of the black box of the power supply into a folder assigned by the user. Within the I<sup>2</sup>C protocol this upload is accomplished by the upload\_black\_box (0xF0) command described below. GE provides a Graphical User Interface (GUI) that de-codes the contents of the black box into a set of records that can be reviewed by the user.

**Upload black box(0xF0):** This command executes the upload from the power supply to a file of the user's choice.

The 100ms delay prior to the restart is mandatory to provide enough time for the power supply to gather the required data from the secondary DSP controller.

1	8	1	8	1
S	Slave addr	Wr	A	Cmd - 0xF0

8	1	8	1
Start address - msb	A	Start address - lsb	A

8	1	.....	delay 100ms
Length = N ( $\leq 32$ )	A		

1	8	1	8	1	8	1
Sr	Slave addr	Rd	A	Length $\leq 32$	A	Byte 0
						A

8	1	8	1	1
.....	Byte N-1	A	PEC	No-Ack
.....				P



# CP3500AC65TEZ High Efficiency Power Supply

Input: 100-240 Vac; 3500W capable; 65 Vdc @ 3500W; 5 Vdc @ 10W

If a transmission error occurs, or if the uC did not receive the data from the DSP, the uC may set the length to 0, issue a PEC and terminate the transmission.

The data array supported by rev 1.3 of the GE Interface Adapter is 32 x 64 comprising 2048 bytes of data.

Start Address	0 .....	Byte .....	31
0000h			
0020h			
0040h			
.			
.			
.			
.			
.			
.			
.			
07E0h			

## CP3500AC65TEZ High Efficiency Power Supply

Input: 100-240 Vac; 3500W capable; 65 Vdc @ 3500W; 5 Vdc @ 10W

Table 1: Alarm and LED state summary

Condition	Power Supply LED State				Monitoring Signals			
	AC OK Green	DC OK Green	Service Amber	Fault Red	Fault	OTW	PG	Module Present
OK	1	1	0	0	HI	HI	HI	LO
Thermal Alarm (5C before shutdown)	1	1	1	0	HI	LO	HI	LO
Thermal Shutdown	1	0	1	1	LO	LO	LO	LO
Defective Fan	1	? <sup>24</sup>	0	1	LO	HI	LO	LO
Blown AC Fuse in Unit	1	0	0	1	LO	HI	LO	LO
AC Present but not within limits	Blinks	0	0	0	HI	HI	LO	LO
AC not present <sup>1</sup>	0	0	0	0	HI	HI	LO	LO
Boost Stage Failure	1	0	0	1	LO	HI	LO	LO
Over Voltage Latched Shutdown	1	0	0	1	LO	HI	LO	LO
Over Current	1	Blinks	0	0	HI	HI	Pulsing <sup>4</sup>	LO
Non-catastrophic Internal Failure <sup>2</sup>	1	1	0	1	LO	HI	HI	LO
Standby (remote)	1	0	0	0	HI	HI	LO	LO
Service Request (PMBus mode)	1	1	Blinks	0	HI	HI	HI	LO
Communications Fault (RS485 mode)	1	1	0	Blinks	HI	HI	HI	LO

<sup>1</sup> This signal is correct if the power supply is back biased from other power supplies in the shelf.

<sup>2</sup> Any detectable fault condition that does not cause a shutting down. For example, ORing FET failure, boost section out of regulation, etc.

<sup>3</sup> Signal transition from HI to LO is output load dependent.

<sup>4</sup> Pulsing at a duty cycle of 1ms as long as the unit is in overload.

Table 2: Signal Definitions

All hardware alarm signals (Fault#, PG#, OTW#) are open drain FETs. These signals need to be pulled HI to either 3.3V or 5V. Maximum sink current 5mA. An active LO signal (< 0.4V<sub>DC</sub>) state. All signals are referenced to Logic\_GRD unless otherwise stated.

Function	Label	Type	Description
Output control	ON/OFF	Input	If shorted to Logic_GRD main output is ON in Analog or PMBus mode.
Power Good Warning	PG#	Output	Open drain FET; Changes to LO if an imminent loss of the main output may occur.
i <sup>2</sup> C Interrupt	Alert#	Output	Active LO.
Power Supply Fault	Fault#	Output	An open drain FET; normally HI, changes to LO.
Module Present	MOD_PRES	Output	Short pin, see Status and Control description for further information on this signal.
Interlock	Interlock	Input	Short pin, controls main output during hot-insertion and extraction. Ref: Vout ( - )
Protocol select	Protocol	Input	Selects operational mode. Ref: Vout ( - ). No-connect PMBus, 10kΩ - RS485
Margining	Vprog	Input	Changes the set point of the main output.
i2c address	Unit_ID	Input	Voltage level selecting the A3 - A0 bits of the address byte
i2c address	Rack_ID	Input	Voltage level selecting the A3 - A0 bits of the address byte
Back bias	8V_INT	Bi-direct	Used to back bias the DSP from operating power supplies. Ref: Vout ( - ).
Standby power	5VA	Output	5V at 2A provided for external use
Current Share	Ishare	Bi-direct	A single wire active-current-share interconnect between power supplies. Ref: Vout ( - ).
i <sup>2</sup> C Line	SCL	Input	PMBus
i <sup>2</sup> C Line	SDA	Bi-direct	PMBus
RS485 Line	RS_485+	Bi-direct	RS485 line +, referenced to Logic_Gnd

<sup>24</sup> A single fan fault may not cause a shutdown. Shutdown is controlled by internal unit temperatures. A double fan fault causes an immediate shutdown.

# CP3500AC65TEZ High Efficiency Power Supply

Input: 100-240 Vac; 3500W capable; 65 Vdc @ 3500W; 5 Vdc @ 10W

RS485 Line	RS_485-	Bi-direct	RS485 line -, referenced to Logic_Gnd
------------	---------	-----------	---------------------------------------

## Mechanical Outline

### Dimensions

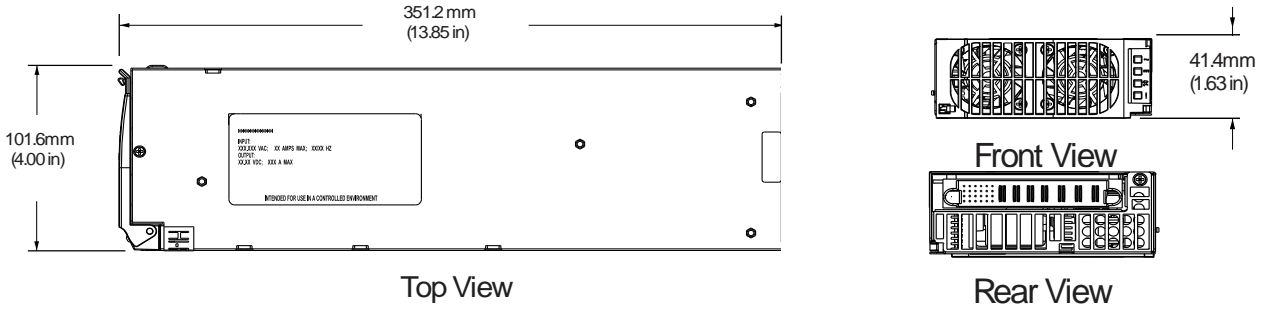

### Shelf insertion keying

The cover of the power supply is notched to ensure that it gets inserted into the correct shelf. The notch is located to accept the key in position "4"

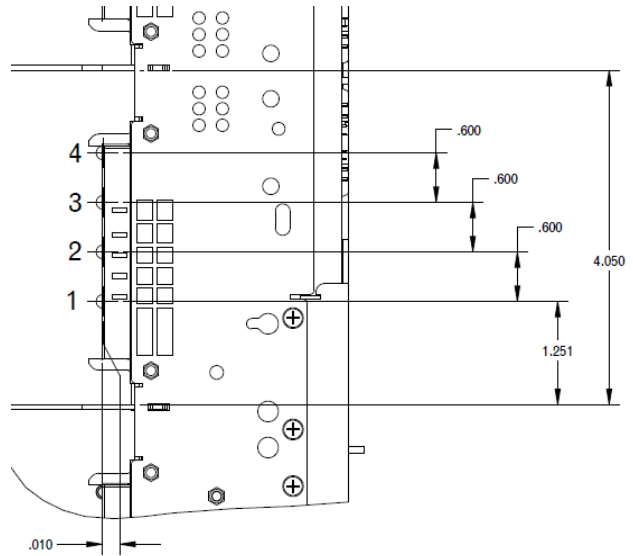

**Output Connector:** TE – 3-6450832-8, or FCI: 10106262-7006001LF

**Mating Connector:** right angle PWB mate – all pins: TE – 1-6450872-6, FCI – 10106264-7006001LF;  
 right angle PWB mate except pass-thru input power: TE – 6450874-3, FCI – 10106265-70CB001LF

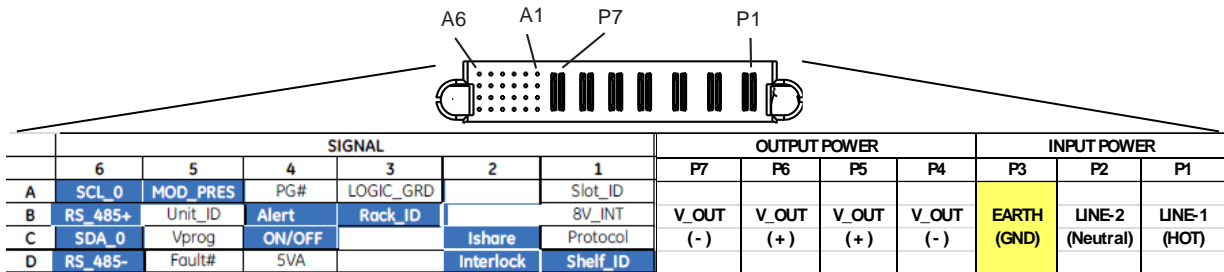

SCL, SDA, MOD\_PRES, Alert, RS\_485+, RS\_485-, Ishare, Interlock, on/off, Rack\_ID, Shelf\_ID, are last to make and first to break. Earth is first to make, last to break.

Signal pin columns 1 and 2 are referenced to Vout-.

Signal pin columns 3, 4, 5, and 6 are referenced to LOGIC\_GRD.

## CP3500AC65TEZ High Efficiency Power Supply

Input: 100-240 Vac; 3500W capable; 65 Vdc @ 3500W; 5 Vdc @ 10W

### This is a Conformally Coated Product

This power supply is conformally coated for additional protection against either humidity or dust born particles.

### Front Panel LEDs

	Analog Mode	I <sup>2</sup> C Mode	RS485 Mode
<input type="checkbox"/> ~	←	<b>ON:</b> Input ok <b>Blinking:</b> Input out of limits	→
<input type="checkbox"/> ≡	←	<b>ON:</b> Output ok <b>Blinking:</b> Overload	→
<input type="checkbox"/> ✖	<b>ON:</b> Over-temperature Warning	<b>ON:</b> Over-temperature Warning <b>Blinking:</b> Service	<b>ON:</b> Over-temperature Warning
<input type="checkbox"/> !	←	<b>ON:</b> Fault	→ <b>ON:</b> Fault <b>Blinking:</b> Not communicating

## CP3500AC65TEZ High Efficiency Power Supply

Input: 100-240 Vac; 3500W capable; 65 Vdc @ 3500W; 5 Vdc @ 10W

### Appendix

#### Latched status states until cleared

The following bits are sticky until cleared by the customer

**Or'ing test failed or passed:** The customer needs to delete the information (clear\_faults) thus indicating that he received the information.

**Shutdown:** It tells the customer that the power supply output has been turned OFF

**OV, UV, OC, fan, input, unknown warnings & faults, CML Errors, Internal or External Fault:** must be sticky







**OC and OT response** registers are in their own confined state. The only way these should change is by commanding the change by the controller. Therefore, they are sticky because a clear\_faults should never change them.

All fault information is sticky (if the fault persists after a clear\_faults has been issued then the fault state will reassert), all operational state information is not sticky.

# CP3500AC65TEZ High Efficiency Power Supply

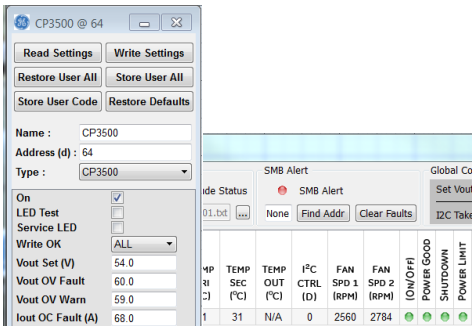
Input: 100-240 Vac; 3500W capable; 65 Vdc @ 3500W; 5 Vdc @ 10W

## Accessories

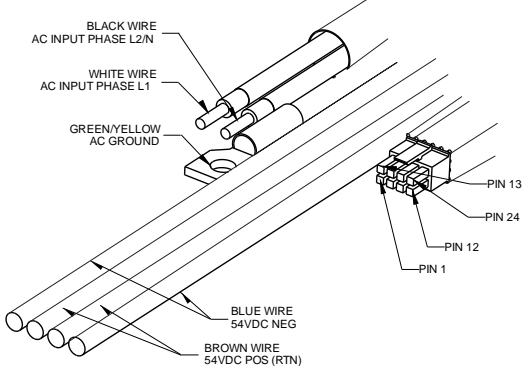
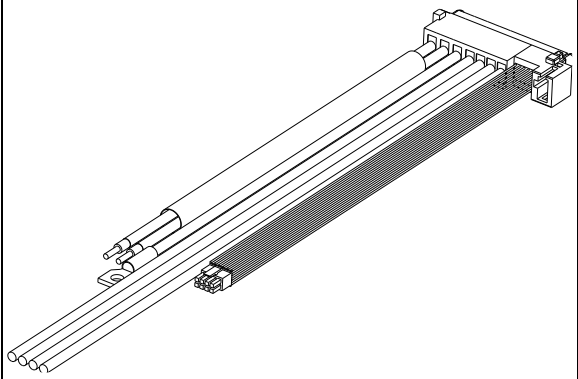
Item	Description	Part number
	<p>1u_CP3500AC65_interface: Power supply interface board. This debug tool can be used to evaluate the performance of the power supply. The input interface is a standard IEC 320 C20 type socket. Outputs are connected via standard 0.25" fast-ons.</p>	<p>7000202078A</p>
	<p>Isolated Interface Adapter Kit – interface between a USB port and the I<sup>2</sup>C connector on the power supply interface board. Includes a cable set to the PC and to the 1u_CP3500AC65_interface board above.</p>	<p>150036482</p>
	<p>The site below downloads the GE Digital Power Insight™ software tools, including the pro_GUI. When the download is complete, icons for the various utilities will appear on the desktop. Click on pro_GUI.exe  to start the program after the download is complete.  <a href="http://powertalk.campaigns.abb.com/DigitalPowerInsight.html">http://powertalk.campaigns.abb.com/DigitalPowerInsight.html</a></p> <p>Graphical User Interface Manual; The GUI download created a directory  In that directory start the DPI_manual.pdf file.</p>	<p>GUI needs to be upgraded to be compatible with this power supply</p>
<p>Software: Remote Upgrade</p>	<p>This GUI upgrades the application codes of all three processors inside the power supply. Available in both I<sup>2</sup>C and GP modes of operation. Requires both the interface board and the Isolated Interface Adapter kit revision 1.5 or higher.</p>	<p>See GE website</p>
<p>Software: Black Box</p>	<p>This GUI translates and displays the contents of the Black Box</p>	<p>In development</p>
	<p>Designed to mount into standard 19" EIA-310-D racks, these GE shelves provide a turn-key solution for customers. The selection guide is documented on the GE website.</p>	<p>the ordering and commcode :                  J2014003L003                  1600264425A</p>
 <p>See next page for pin assignment</p>	<p>Single unit cable assembly</p> 	<p>850045138</p>

## CP3500AC65TEZ High Efficiency Power Supply

Input: 100-240 Vac; 3500W capable; 65 Vdc @ 3500W; 5 Vdc @ 10W

### Ordering Information

Please contact your GE Sales Representative for pricing, availability and optional features.

Table 4: Device Codes

Item	Description	Comcode
CP3500AC65TEZ	3500W, 5Vdc @ 2A, RoHS Compliant, Black faceplate, conformal coating	1600152518A

### Contact Us

For more information, call us at

USA/Canada:

**+1 877 546 3243**, or +1 972 244 9288

Asia-Pacific:

**+86-21-53899666**

Europe, Middle-East and Africa:

**+49.89.878067-280**

[Go.ABB/Industrial](http://Go.ABB/Industrial)



GE Critical Power reserves the right to make changes to the product(s) or information contained herein without notice, and no liability is assumed as a result of their use or application. No rights under any patent accompany the sale of any such product(s) or information.