

ESTW015A0F Series(Eighth-Brick); DC-DC Converter Power Modules

36-75Vdc Input; 3.3Vdc, 15A Output

STINGRAY™ SERIES

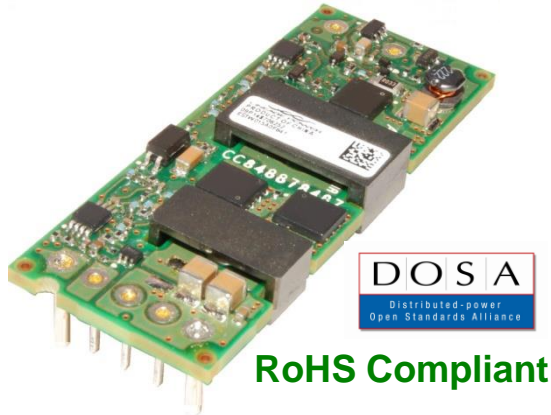

Features

- Compliant to RoHS Directive 2011/65/EU and amended Directive (EU) 2015/863 (-Z versions)
- Compliant to REACH Directive (EC) No 1907/2006
- Delivers up to 15A Output current
- High efficiency 91% at full load ($V_{in}=48V_{dc}$)
- Full load at $T_A=85^\circ\text{C}$ for airflow of 1 m/s(200 LFM) or greater
- Industry standard, DOSA compliant footprint
57.9mm x 22.8mm x 8.5mm
(2.28 in x 0.9 in x 0.335 in)
- Wide input voltage range: 36-75 V_{dc}
- Tightly regulated output
- Constant switching frequency
- Positive remote On/Off logic
- Input under voltage protection
- Output overcurrent and overvoltage protection
- Over-temperature protection
- Remote sense
- Output Voltage adjust: 80% to 110% of $V_{o,nom}$
- Wide operating temperature range (-40°C to 85°C)
- ANSI/UL* 62368-1 and CAN/CSA† C22.2 No. 62368-1 Recognized, DIN VDE‡ 0868-1/A11:2017 (EN62368-1:2014/A11:2017)
- CE mark meets 2014/35/EU directive§
- Meets the voltage and current requirements for ETSI 300-132-2 and complies with and licensed for Basic insulation rating
- 2250 V_{dc} Isolation tested in compliance with IEEE 802.3‡ PoE standards
- ISO**9001 and ISO 14001 certified manufacturing facilities

Applications

- Distributed power architectures
- Wireless networks
- Access and optical network Equipment
- Enterprise Networks including Power over Ethernet (PoE)
- Latest generation IC's (DSP, FPGA, ASIC) and Microprocessor powered applications

Options

- Negative Remote On/Off logic (-1 option, preferred/standard)
- Auto-restart (-4 option, preferred/standard)
- Trimmed leads (-6 or -8 options)

Description

The ESTW015A0F, Eighth-brick power modules are cost optimized isolated dc-dc converters that can deliver up to 15A of output current and provide a precisely regulated output voltage over a wide range of input voltages ($V_{in} = 36 - 75V_{dc}$). The module achieves full load efficiency of 91% at 3.3 V_{dc} output voltage. The open frame modules construction, available in through-hole packaging, enable designers to develop cost- and space-efficient solutions. Standard features include remote On/Off, remote sense, output voltage adjustment, overvoltage, overcurrent and overtemperature protection.

* Trademark of General Electric Company

‡UL is a registered trademark of Underwriters Laboratories, Inc.

† CSA is a registered trademark of Canadian Standards Association.

‡ VDE is a trademark of Verband Deutscher Elektrotechniker e.V.

§ This product is intended for integration into end-user equipment. All of the required procedures of end-use equipment should be followed.

‡ IEEE and 802 are registered trademarks of the Institute of Electrical and Electronics Engineers, Incorporated.

** ISO is a registered trademark of the International Organization of Standards

ESTW015A0F Series; Eighth Brick Power Modules

36-75Vdc Input; 3.3Vdc, 15A Output

Absolute Maximum Ratings

Stresses in excess of the absolute maximum ratings can cause permanent damage to the device. These are absolute stress ratings only, functional operation of the device is not implied at these or any other conditions in excess of those given in the operations sections of the data sheet. Exposure to absolute maximum ratings for extended periods can adversely affect the device reliability.

| Parameter | Device | Symbol | Min | Max | Unit |
|---|--------|----------------|------|------|-----------------|
| Input Voltage | | | | | |
| Continuous | All | V_{IN} | -0.3 | 80 | V _{dc} |
| Transient, operational (≤ 100 ms) | All | $V_{IN,trans}$ | -0.3 | 100 | V _{dc} |
| Operating Ambient Temperature (see Thermal Considerations section) | All | T_A | -40 | 85 | °C |
| Storage Temperature | All | T_{stg} | -55 | 125 | °C |
| I/O Isolation voltage (100% factory Hi-Pot tested) | All | — | — | 2250 | V _{dc} |

Electrical Specifications

Unless otherwise indicated, specifications apply over all operating input voltage, resistive load, and temperature conditions.

| Parameter | Device | Symbol | Min | Typ | Max | Unit |
|---|--------|-------------------|-----|-----|-----|-------------------|
| Operating Input Voltage | All | V_{IN} | 36 | 48 | 75 | V _{dc} |
| Maximum Input Current ($V_{IN} = V_{IN,min}$ to $V_{IN,max}$, $I_O = I_{O,max}$) | All | $I_{IN,max}$ | | | 2.0 | A _{dc} |
| Input No Load Current ($V_{IN} = V_{IN,nom}$, $I_O = 0$, module enabled) | All | $I_{IN,No\ load}$ | | 30 | | mA |
| Input Stand-by Current ($V_{IN} = V_{IN,nom}$, module disabled) | All | $I_{IN,stand-by}$ | | 6 | 8 | mA |
| Inrush Transient | All | I^2t | | | 1 | A ² s |
| Input Reflected Ripple Current, peak-to-peak (5Hz to 20MHz, 1 μ H source impedance; $V_{IN,min}$ to $V_{IN,max}$, $I_O = I_{O,max}$; See Test configuration section) | All | | | 30 | | mA _{p-p} |
| Input Ripple Rejection (120Hz) | All | | | 50 | | dB |

CAUTION: This power module is not internally fused. An input line fuse must always be used.

This power module can be used in a wide variety of applications, ranging from simple standalone operation to an integrated part of sophisticated power architectures. To preserve maximum flexibility, internal fusing is not included, however, to achieve maximum safety and system protection, always use an input line fuse. The safety agencies require a fast-acting fuse with a maximum rating of 5 A (see Safety Considerations section). Based on the information provided in this data sheet on inrush energy and maximum dc input current, the same type of fuse with a lower rating can be used. Refer to the fuse manufacturer's data sheet for further information.

ESTW015A0F Series; Eighth Brick Power Modules

36-75Vdc Input; 3.3Vdc, 15A Output

Electrical Specifications (continued)

| Parameter | Device | Symbol | Min | Typ | Max | Unit |
|---|-------------------|----------------------------|----------------------|----------------------|-----------------|--|
| Nominal Output Voltage Set-point $V_{IN}=V_{IN, nom}, I_O=I_{O, max}, T_A=25^{\circ}C$ | All | $V_{O, set}$ | 3.25 | 3.3 | 3.35 | V _{dc} |
| Output Voltage (Over all operating input voltage, resistive load, and temperature conditions until end of life) | All | V_O | 3.2 | — | 3.4 | V _{dc} |
| Output Regulation Line ($V_{IN}=V_{IN, min}$ to $V_{IN, max}$) Load ($I_O=I_{O, min}$ to $I_{O, max}$) Temperature ($T_{ref}=T_{A, min}$ to $T_{A, max}$) | All All All | — — — | — — — | — — ± 0.2 | ± 0.1 10 | % $V_{O, set}$ mV % $V_{O, set}$ |
| Output Ripple and Noise on nominal output ($V_{IN}=V_{IN, nom}, I_O=I_{O, max}, T_A=T_{A, min}$ to $T_{A, max}$) RMS (5Hz to 20MHz bandwidth) Peak-to-Peak (5Hz to 20MHz bandwidth) | All All | — — | — — | 8 40 | 20 75 | mV _{rms} mV _{pk-pk} |
| External Capacitance | All | $C_{O, max}$ | 0 | — | 5,000 | μF |
| Output Current | All | I_O | 0 | — | 15.0 | A _{dc} |
| Output Current Limit Inception (Hiccup Mode) ($V_O=90\%$ of $V_{O, set}$) | All | $I_{O, lim}$ | — | 19 | — | A _{dc} |
| Output Short-Circuit Current ($V_O \leq 250mV$) (Hiccup Mode) | All | $I_{O, s/c}$ | — | 60 2.5 | — | A _{pk} A _{AVG} |
| Efficiency $V_{IN}=V_{IN, nom}, T_A=25^{\circ}C, I_O=I_{O, max}, V_O=V_{O, set}$ $V_{IN}=V_{IN, nom}, T_A=25^{\circ}C, I_O=10A, V_O=V_{O, set}$ $V_{IN}=V_{IN, nom}, T_A=25^{\circ}C, I_O=4A, V_O=V_{O, set}$ | All All All | η η η | 90.0 90.0 85.5 | 91.0 91.0 87.0 | — | % % % |
| Switching Frequency | All | f_{sw} | — | 355 | — | kHz |
| Dynamic Load Response ($di_O/dt=0.1A/\mu s; V_{IN}=V_{IN, nom}; T_A=25^{\circ}C$) Load Change from $I_O=50\%$ to 75% or 25% to 50% of $I_{O, max}$ Peak Deviation Settling Time ($V_O < 10\%$ peak deviation) | All All | V_{pk} t_s | — — | 210 200 | — — | mV μs |

Isolation Specifications

| Parameter | Device | Symbol | Min | Typ | Max | Unit |
|--|--------|-----------|-----|------|------|-----------------|
| Isolation Capacitance | All | C_{iso} | — | 1000 | — | pF |
| Isolation Resistance | All | R_{iso} | 10 | — | — | M Ω |
| I/O Isolation Voltage (100% factory Hi-pot tested) | All | All | — | — | 2250 | V _{dc} |

General Specifications

| Parameter | Device | Symbol | Min | Typ | Max | Unit |
|--|--------|--------|-----|------------|-----|------------------------|
| Calculated Reliability based upon Telcordia SR-332 Issue 2: Method I Case 3 ($I_O=80\%I_{O, max}, T_A=40^{\circ}C$, airflow = 200 lfm, 90% confidence) | All | FIT | — | 212.2 | — | 10 ⁹ /Hours |
| | All | MTBF | — | 4,713,305 | — | Hours |
| Weight | All | — | — | 15.2 (0.6) | — | g (oz.) |

ESTW015A0F Series; Eighth Brick Power Modules

36-75Vdc Input; 3.3Vdc, 15A Output

Feature Specifications

Unless otherwise indicated, specifications apply over all operating input voltage, resistive load, and temperature conditions. See Feature Descriptions for additional information.

| Parameter | Device | Symbol | Min | Typ | Max | Unit |
|---|--------|----------------|------|-----|------|----------------|
| Remote On/Off Signal Interface ($V_{IN}=V_{IN, min}$ to $V_{IN, max}$; open collector or equivalent, Signal referenced to V_{IN} terminal) Negative Logic: device code suffix "1" Logic Low = module On, Logic High = module Off Positive Logic: No device code suffix required Logic Low = module Off, Logic High = module On | | | | | | |
| Logic Low - Remote On/Off Current ($V_{on/off} = -0.7 V_{dc}$) | All | $I_{on/off}$ | — | — | 0.15 | mA |
| Logic Low - On/Off Voltage | All | $V_{on/off}$ | -0.7 | — | 0.6 | V_{dc} |
| Logic High Voltage ($I_{on/off} = 0A_{dc}$) | All | $V_{on/off}$ | 2.4 | — | 6.7 | V_{dc} |
| Logic High maximum leakage current | All | $I_{on/off}$ | — | — | 25 | μA |
| Turn-On Delay ¹ and Rise Times ($I_O=I_{O, max}$, $V_{IN}=V_{IN, nom}$, $T_A = 25^\circ C$) Case 1: Input power is applied for >1 second and then the On/Off input is set to ON (T_{delay} = time from instant On/Off signal is ON until $V_O = 10\%$ of $V_{O, set}$) Case 2: On/Off input is set to Logic Low (Module ON) and then input power is applied (T_{delay} = time at which $V_{IN} = V_{IN, min}$ until $V_O=10\%$ of $V_{O, set}$) Output voltage Rise time (time for V_O to rise from 10% of $V_{O, set}$ to 90% of $V_{O, set}$) | All | T_{delay} | — | 12 | — | msec |
| | All | T_{delay} | — | 20 | — | msec |
| | All | T_{rise} | — | 4 | — | msec |
| Output voltage overshoot – Startup $I_O= I_{O, max}$; $V_{IN}=V_{IN, min}$ to $V_{IN, max}$, $T_A = 25^\circ C$ | All | | | — | 5 | % $V_{O, set}$ |
| Remote Sense Range | All | V_{SENSE} | | | 10 | % $V_{O, set}$ |
| Output Voltage Adjustment Range | All | | -20 | | +10 | % $V_{O, set}$ |
| Output Overvoltage Protection ($C_O=220\mu F$) | All | $V_{O, limit}$ | 3.9 | | 5.0 | V_{dc} |
| Overtemperature Protection – Hiccup Auto Restart | All | T_{ref} | — | 138 | — | $^\circ C$ |
| Input Undervoltage Lockout | All | V_{UVLO} | | | | |
| Turn-on Threshold | | | — | 32 | 34.5 | V_{dc} |
| Turn-off Threshold | | | 27.5 | 30 | — | V_{dc} |
| Hysteresis | | | 1 | 2 | — | V_{dc} |

1. The module has an adaptable extended Turn-On Delay interval, T_{delay} , of 25mS. The extended T_{delay} will occur when the module restarts following either: 1) the rapid cycling of V_{in} from normal levels to less than the Input Undervoltage Lockout (which causes module shutdown), and then back to normal; or 2) toggling the on/off signal from on to off and back to on without removing the input voltage. The normal Turn-On Delay interval, T_{delay} , will occur whenever a module restarts with input voltage removed from the module for the preceding 1 second.

ESTW015A0F Series; Eighth Brick Power Modules

36-75Vdc Input; 3.3Vdc, 15A Output

Characteristic Curves

The following figures provide typical characteristics for the ESTW015A0F (3.3V, 15A) at 25°C. The figures are identical for either positive or negative remote On/Off logic.

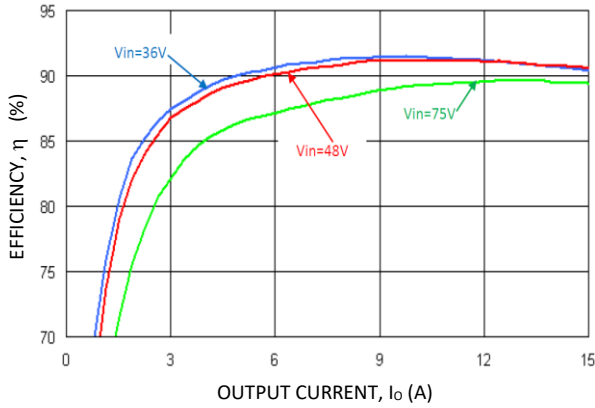

Figure 1. Converter Efficiency versus Output Current.

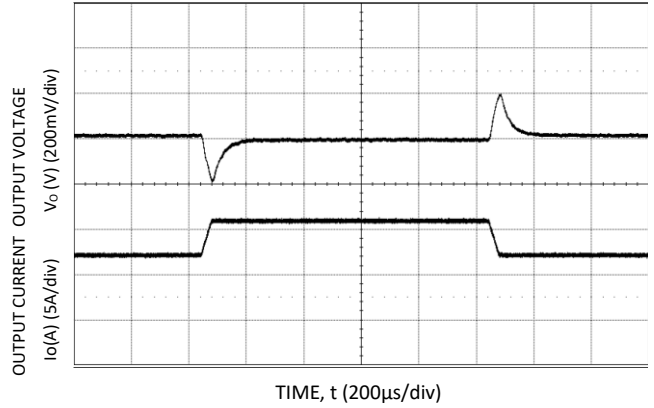

Figure 4. Transient Response to 0.1A/μS Dynamic Load Change from 50% to 75% to 50% of full load.

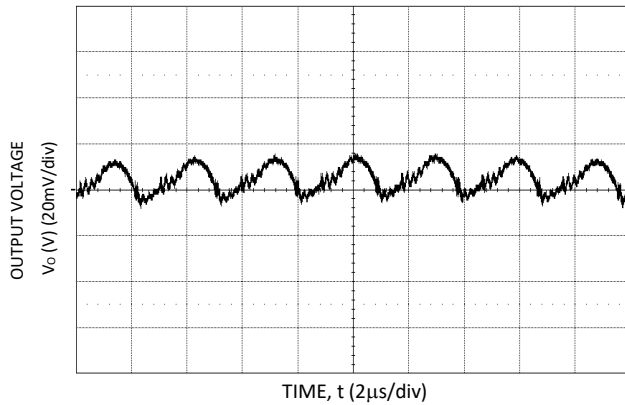

Figure 2. Typical output ripple and noise ($V_{IN} = V_{IN,NOM}$, $I_o = I_{o,max}$).

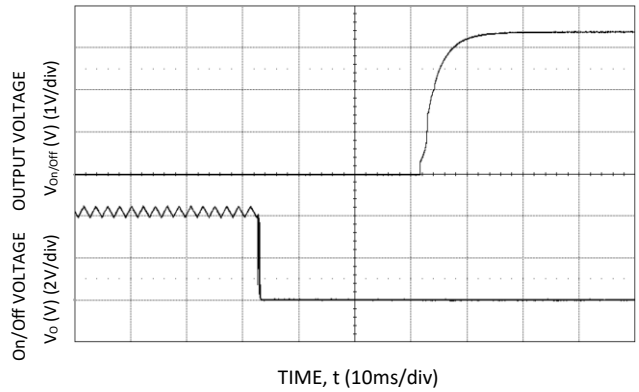

Figure 5. Typical Start-up Using Remote On/Off, negative logic version shown ($V_{IN} = V_{IN,NOM}$, $I_o = I_{o,max}$).

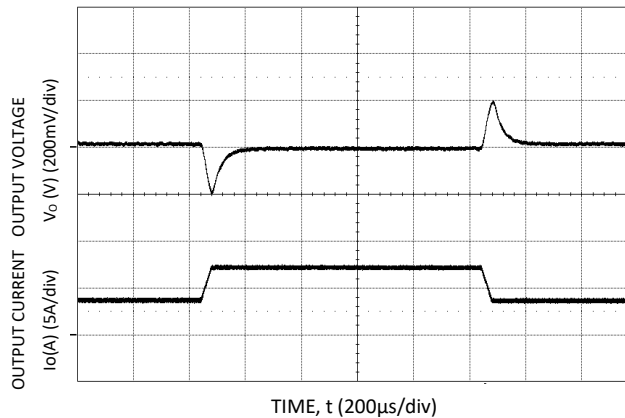

Figure 3. Transient Response to 0.1A/μS Dynamic Load Change from 25% to 50% to 25% of full load.

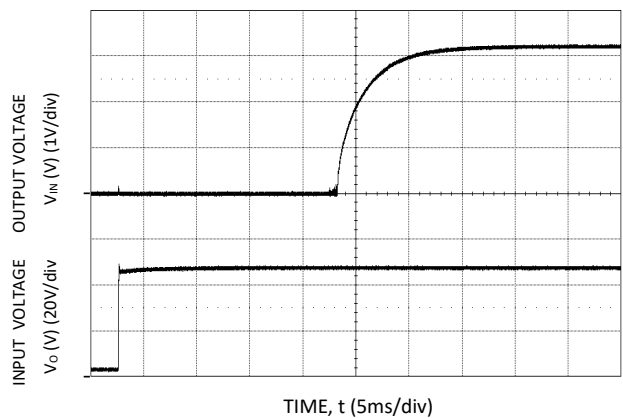
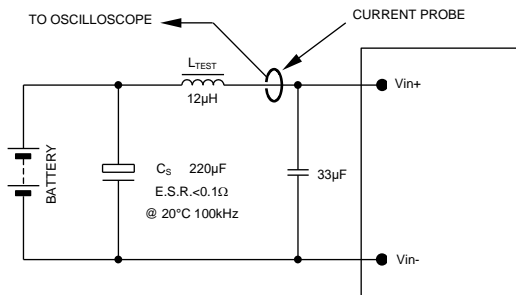

Figure 6. Typical Start-up Using Input Voltage ($V_{IN} = V_{IN,NOM}$, $I_o = I_{o,max}$).

ESTW015A0F Series; Eighth Brick Power Modules

36-75Vdc Input; 3.3Vdc, 15A Output

Test Configurations



NOTE: Measure input reflected ripple current with a simulated source inductance (L_{TEST}) of 12µH. Capacitor C_S offsets possible battery impedance. Measure current as shown above.

Figure 7. Input Reflected Ripple Current Test Setup.

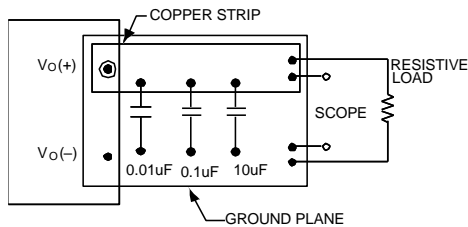

NOTE: All voltage measurements to be taken at the module terminals, as shown above. If sockets are used then Kelvin connections are required at the module terminals to avoid measurement errors due to socket contact resistance.

Figure 8. Output Ripple and Noise Test Setup.

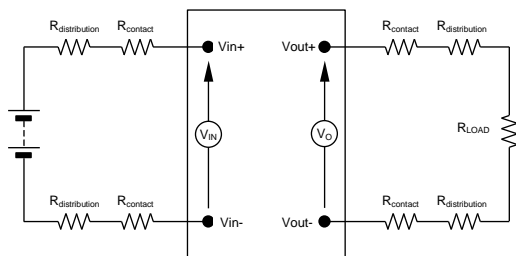

NOTE: All voltage measurements to be taken at the module terminals, as shown above. If sockets are used then Kelvin connections are required at the module terminals to avoid measurement errors due to socket contact resistance.

Figure 9. Output Voltage and Efficiency Test Setup.

$$\text{Efficiency } \eta = \frac{V_O \cdot I_O}{V_{IN} \cdot I_{IN}} \times 100 \%$$

Design Considerations

Input Filtering

The power module should be connected to a low ac-impedance source. Highly inductive source impedance can affect the stability of the power module. For the test configuration in Figure 7 a 33µF electrolytic capacitor (ESR<0.7Ω at 100kHz), mounted close to the power module helps ensure the stability of the unit. Consult the factory for further application guidelines.

Safety Considerations

For safety agency approval the power module must be installed in compliance with the spacing and separation requirements of the end-use safety agency standards, i.e., UL ANSI/UL 62368-1 and CAN/CSA C22.2 No. 62368-1 Recognized, DIN VDE 0868-1/A11:2017 (EN62368-1:2014/A11:2017)

If the input source is non-SELV (ELV or a hazardous voltage greater than 60 Vdc and less than or equal to 75Vdc), for the module’s output to be considered as meeting the requirements for safety extra-low voltage (SELV) or ES1, all of the following must be true:

- The input source is to be provided with reinforced insulation from any other hazardous voltages, including the ac mains.
- One V_{IN} pin and one V_{OUT} pin are to be grounded, or both the input and output pins are to be kept floating.
- The input pins of the module are not operator accessible.
- Another SELV or ES1 reliability test is conducted on the whole system (combination of supply source and subject module), as required by the safety agencies, to verify that under a single fault, hazardous voltages do not appear at the module’s output.

Note: Do not ground either of the input pins of the module without grounding one of the output pins. This may allow a non-SELV/ES1 voltage to appear between the output pins and ground.

The power module has safety extra-low voltage (SELV) or ES1 outputs when all inputs are SELV or ES1.

All flammable materials used in the manufacturing of these modules are rated 94V-0, or tested to the UL60950 A.2 for reduced thickness.

For input voltages exceeding –60 Vdc but less than or equal to –75 Vdc, these converters have been evaluated to the applicable requirements of BASIC INSULATION between secondary DC MAINS DISTRIBUTION input (classified as TNV-2 in Europe) and unearthed SELV outputs.

The input to these units is to be provided with a maximum 5 A fast-acting fuse in the ungrounded lead.

ESTW015A0F Series; Eighth Brick Power Modules

36-75Vdc Input; 3.3Vdc, 15A Output

Feature Description

Remote On/Off

Two remote on/off options are available. Positive logic turns the module on during a logic high voltage on the ON/OFF pin, and off during a logic low. Negative logic remote On/Off, device code suffix "1", turns the module off during a logic high and on during a logic low.

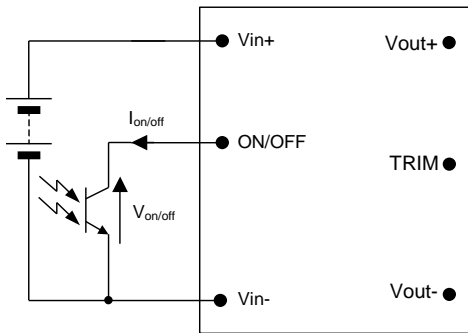

Figure 10. Remote On/Off Implementation.

To turn the power module on and off, the user must supply a switch (open collector or equivalent) to control the voltage ($V_{on/off}$) between the ON/OFF terminal and the $V_{IN(-)}$ terminal (see Figure 10). Logic low is $-0.7V \leq V_{on/off} \leq 0.6V$. The maximum $I_{on/off}$ during a logic low is 0.15mA, the switch should maintain a logic low level while sinking this current.

During a logic high, the typical maximum $V_{on/off}$ generated by the module is 6.7V, and the maximum allowable leakage current at $V_{on/off} = 2.4V$ is 25 μ A.

If not using the remote on/off feature:

For positive logic, leave the ON/OFF pin open.

For negative logic, short the ON/OFF pin to $V_{IN(-)}$.

Remote Sense

Remote sense minimizes the effects of distribution losses by regulating the voltage at the remote-sense connections (See Figure 11). The voltage between the remote-sense pins and the output terminals must not exceed the output voltage sense range given in the Feature Specifications table:

$$[V_o(+)-V_o(-)] - [SENSE(+)-SENSE(-)] \leq 0.5 V$$

Although the output voltage can be increased by both the remote sense and by the trim, the maximum increase for the output voltage is not the sum of both. The maximum increase is the larger of either the remote sense or the trim.

The amount of power delivered by the module is defined as the voltage at the output terminals multiplied by the output current. When using remote sense and trim, the output voltage of the module can be increased, which at the same output current would increase the power output of the module. Care should be taken to ensure that the maximum output power of the module remains at or below the

maximum rated power (Maximum rated power = $V_{o,set} \times I_{o,max}$).

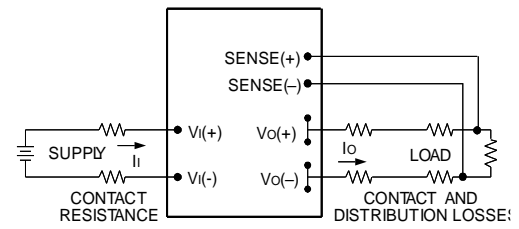

Figure 11. Circuit Configuration for remote sense .

Input Undervoltage Lockout

At input voltages below the input undervoltage lockout limit, the module operation is disabled. The module will only begin to operate once the input voltage is raised above the undervoltage lockout turn-on threshold, $V_{UV/ON}$.

Once operating, the module will continue to operate until the input voltage is taken below the undervoltage turn-off threshold, $V_{UV/OFF}$.

Overtemperature Protection

To provide protection under overtemperature fault conditions, the unit is equipped with a thermal shutdown circuit. The unit will shutdown if the thermal reference points T_{refx} (Figure 13), exceed 138 $^{\circ}$ C (typical). However, the thermal shutdown is not intended as a guarantee that the unit will survive temperatures beyond its rating. The module restarts automatically after the unit cools down below the overtemperature protection thresholds.

Output Overvoltage Protection

The output over voltage protection scheme of the modules has an independent over voltage loop to prevent single point of failure. This protection feature latches in the event of over voltage across the output.

Cycling the on/off pin or input voltage resets the latching protection feature. If the auto-restart option (4) is ordered, the module will automatically restart upon an internally programmed time elapsing.

Overcurrent Protection

To provide protection in a fault (output overload) condition, the unit is equipped with internal current limiting circuitry and can endure current limiting continuously. At the point of current limit inception, the unit enters hiccup mode. If the unit is not configured with auto-restart, then it will latch off following the over current condition. The module can be restarted by cycling the dc input power for at least one second or by toggling the remote on/off signal for at least one second. If the unit is configured with the

ESTW015A0F Series; Eighth Brick Power Modules

36-75Vdc Input; 3.3Vdc, 15A Output

Feature Descriptions (continued)

auto-restart option (4), it will remain in the hiccup mode as long as the overcurrent condition exists; it operates normally, once the output current is brought back into its specified range. The average output current during hiccup is 10% $I_{O,max}$.

Output Voltage Programming

Trimming allows the output voltage set point to be increased or decreased, this is accomplished by connecting an external resistor between the TRIM pin and either the $V_{O}(+)$ pin or the $V_{O}(-)$ pin (Figure 12).

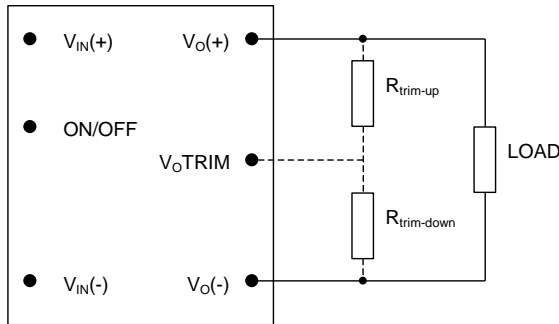

Figure 12. Circuit Configuration to Trim Output Voltage.

Connecting an external resistor ($R_{trim-down}$) between the TRIM pin and the $V_{O}(-)$ (or Sense(-)) pin decreases the output voltage set point. To maintain set point accuracy, the trim resistor tolerance should be $\pm 1.0\%$.

The following equation determines the required external resistor value to obtain a percentage output voltage change of $\Delta\%$

$$R_{trim-down} = \left[\frac{511}{\Delta\%} - 10.22 \right] K\Omega$$

Where
$$\Delta\% = \left(\frac{V_{o,set} - V_{desired}}{V_{o,set}} \right) \times 100$$

For example, to trim-down the output voltage of the module by 8% to 3.036V, $R_{trim-down}$ is calculated as follows:

$$\Delta\% = 8$$

$$R_{trim-down} = \left[\frac{511}{8} - 10.22 \right] K\Omega$$

$$R_{trim-down} = 53.655K\Omega$$

Connecting an external resistor ($R_{trim-up}$) between the TRIM pin and the $V_{O}(+)$ (or Sense (+)) pin increases the output voltage set point. The following equation determines the required external resistor value to obtain a percentage output voltage change of $\Delta\%$:

$$R_{trim-up} = \left[\frac{5.11 \times V_{o,set} \times (100 + \Delta\%)}{1.225 \times \Delta\%} - \frac{511}{\Delta\%} - 10.22 \right] K\Omega$$

Where
$$\Delta\% = \left(\frac{V_{desired} - V_{o,set}}{V_{o,set}} \right) \times 100$$

For example, to trim-up the output voltage of the module by 5% to 3.465V, $R_{trim-up}$ is calculated as follows:

$$\Delta\% = 5$$

$$R_{trim-up} = \left[\frac{5.11 \times 3.3 \times (100 + 5)}{1.225 \times 5} - \frac{511}{5} - 10.22 \right] K\Omega$$

$$R_{trim-up} = 176.7K\Omega$$

The voltage between the $V_{O}(+)$ and $V_{O}(-)$ terminals must not exceed the minimum output overvoltage protection value shown in the Feature Specifications table. This limit includes any increase in voltage due to remote-sense compensation and output voltage set-point adjustment trim.

Although the output voltage can be increased by both the remote sense and by the trim, the maximum increase for the output voltage is not the sum of both. The maximum increase is the larger of either the remote sense or the trim. The amount of power delivered by the module is defined as the voltage at the output terminals multiplied by the output current. When using remote sense and trim, the output voltage of the module can be increased. Therefore, for the same output current, this would increase the output power of the module. Care should be taken to ensure that the maximum output power of the module remains at or below the maximum rated power (Maximum rated power = $V_{O,set} \times I_{O,max}$).

ESTW015A0F Series; Eighth Brick Power Modules

36-75Vdc Input; 3.3Vdc, 15A Output

Thermal Considerations

The power modules operate in a variety of thermal environments; however, sufficient cooling should be provided to help ensure reliable operation.

Considerations include ambient temperature, airflow, module power dissipation, and the need for increased reliability. A reduction in the operating temperature of the module will result in an increase in reliability. The thermal data presented here is based on physical measurements taken in a wind tunnel.

The thermal reference points, T_{ref_x} used in the specifications for open frame modules are shown in Figure 13. For reliable operation T_{ref_1} and T_{ref_2} temperatures should not exceed 125°C and T_{ref_3} temperature should not exceed 110°C.

Please refer to the Application Note “Thermal Characterization Process For Open-Frame Board-Mounted Power Modules” for a detailed discussion of the thermal aspects including maximum device temperatures.

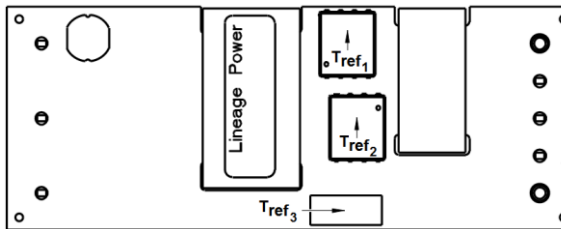

Figure 13. T_{ref} Temperature Measurement Location for Open Frame Module.

Heat Transfer via Convection

Increased airflow over the module enhances the heat transfer via convection. Derating curves, showing the maximum output current that can be delivered by the module versus local ambient temperature (T_A) for natural convection and up to 1m/s (200 ft./min) forced airflow, are shown in Figure 14. Full power up to $T_A=85^\circ\text{C}$, is achieved for airflow of 1 m/s(200 LFM) or greater.

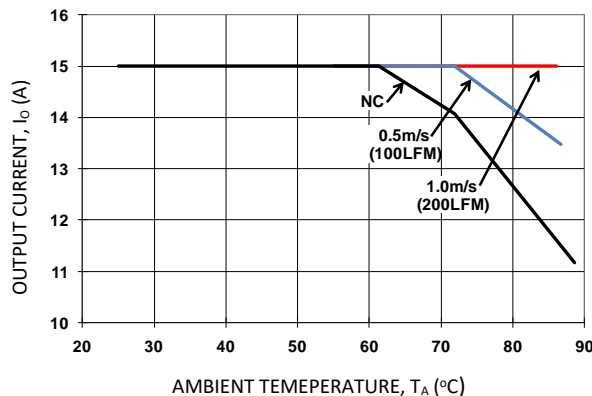

Figure 14. Output Current Derating for the Open Frame Module; Airflow in the Transverse Direction from $V_{out}(+)$ to $V_{out}(-)$; $V_{in}=48V$.

ESTW015A0F Series; Eighth Brick Power Modules

36-75Vdc Input; 3.3Vdc, 15A Output

Pick and Place

The ESTW015A0F modules use an open frame construction and are designed for a fully automated assembly process. The modules are fitted with a label designed to provide a large surface area for pick and place operations. The label meets all the requirements for surface mount processing, as well as safety standards, and is able to withstand reflow temperatures of up to 300°C. The label also carries product information such as product code, serial number and the location of manufacture.

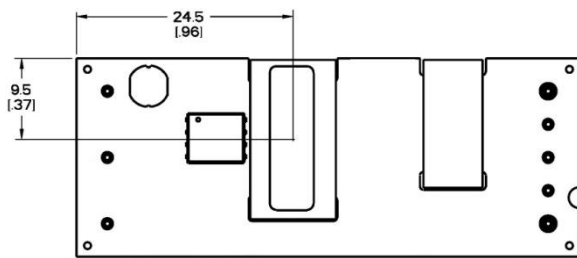

Figure 15. Pick and Place Location.

Nozzle Recommendations

The module weight has been kept to a minimum by using open frame construction. Even so, these modules have a relatively large mass when compared to conventional SMT components. Variables such as nozzle size, tip style, vacuum pressure and placement speed should be considered to optimize this process. The minimum recommended nozzle diameter for reliable operation is 6mm. The maximum nozzle outer diameter, which will safely fit within the allowable component spacing, is 9 mm.

Oblong or oval nozzles up to 11 x 9 mm may also be used within the space available.

Tin Lead Soldering

The ESTW015A0F power modules are lead free modules and can be soldered either in a lead-free solder process or in a conventional Tin/Lead (Sn/Pb) process. It is recommended that the customer review data sheets in order to customize the solder reflow profile for each application board assembly. The following instructions must be observed when soldering these units. Failure to observe these instructions may result in the failure of or cause damage to the modules, and can adversely affect long-term reliability.

In a conventional Tin/Lead (Sn/Pb) solder process peak reflow temperatures are limited to less than 235°C. Typically, the eutectic solder melts at 183°C, wets the land, and subsequently wicks the device connection. Sufficient time must be allowed to fuse the plating on the connection to ensure a reliable solder joint. There are several types of SMT reflow technologies currently used in the industry. These power modules can be reliably soldered using natural forced convection, IR (radiant infrared), or a combination of convection/IR. For reliable soldering the solder reflow

profile should be established by accurately measuring the modules CP connector temperatures.

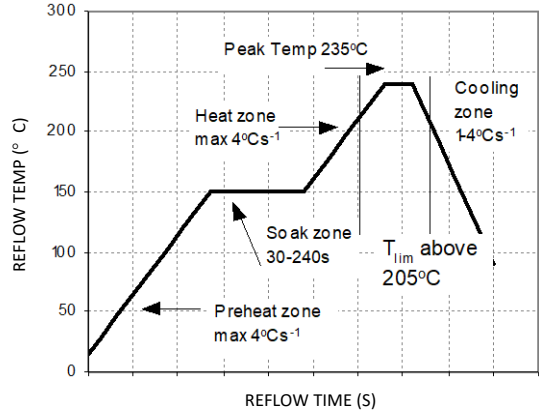

Figure 16. Reflow Profile for Tin/Lead (Sn/Pb) process.

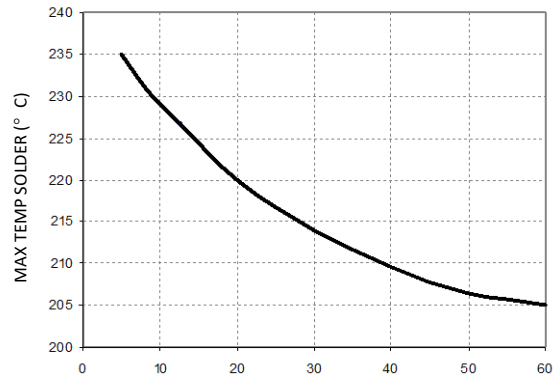

Figure 17. Time Limit Curve Above 205°C for Tin/Lead (Sn/Pb) process

Lead Free Soldering

The -Z version of the ESTW015A0F modules are lead-free (Pb-free) and RoHS compliant and are both forward and backward compatible in a Pb-free and a SnPb soldering process. Failure to observe the instructions below may result in the failure of or cause damage to the modules and can adversely affect long-term reliability.

Pb-free Reflow Profile

Power Systems will comply with J-STD-020 Rev. C (Moisture/Reflow Sensitivity Classification for Nonhermetic Solid State Surface Mount Devices) for both Pb-free solder profiles and MSL classification procedures. This standard provides a recommended forced-air-convection reflow profile based on the volume and thickness of the package (table 4-2). The suggested Pb-free solder paste is Sn/Ag/Cu (SAC). The recommended linear reflow profile using Sn/Ag/Cu solder is shown in Figure 18.

ESTW015A0F Series; Eighth Brick Power Modules

36-75Vdc Input; 3.3Vdc, 15A Output

Post Solder Cleaning and Drying Considerations

Post solder cleaning is usually the final circuit board assembly process prior to electrical board testing. The result of inadequate cleaning and drying can affect both the reliability of a power module and the testability of the finished circuit board assembly. For guidance on appropriate soldering, cleaning and drying procedures, refer to Lineage Power Board

Mounted Power Modules: Soldering and Cleaning
Application Note (AN04-001).

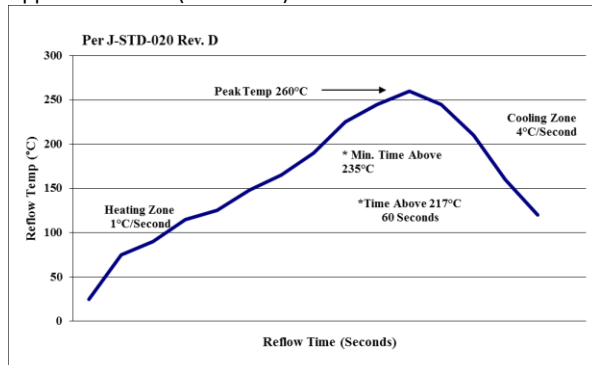

Figure 18. Recommended linear reflow profile using Sn/Ag/Cu solder.

Through-Hole Lead-Free Soldering Information

The RoHS-compliant through-hole products use the SAC (Sn/Ag/Cu) Pb-free solder and RoHS-compliant components. They are designed to be processed through single or dual wave soldering machines. The pins have a RoHS-compliant finish that is compatible with both Pb and Pb-free wave soldering processes. A maximum preheat rate of 3°C/s is suggested. The wave preheat process should be such that the temperature of the power module board is kept below 210°C. For Pb solder, the recommended pot temperature is 260°C, while the Pb-free solder pot is 270°C max. Not all RoHS-compliant through-hole products can be processed with paste-through-hole Pb or Pb-free reflow process. If additional information is needed, please consult with your ABB representative for more details.

ESTW015A0F Series; Eighth Brick Power Modules

36-75Vdc Input; 3.3Vdc, 15A Output

EMC Considerations

The filter circuit schematic and plots in Figure 19 shows a suggested configuration as tested to meet the conducted emission limits of EN55032 Class A.

Note: Customer is ultimately responsible for the proper selection, component rating and verification of the suggested parts based on the end application.

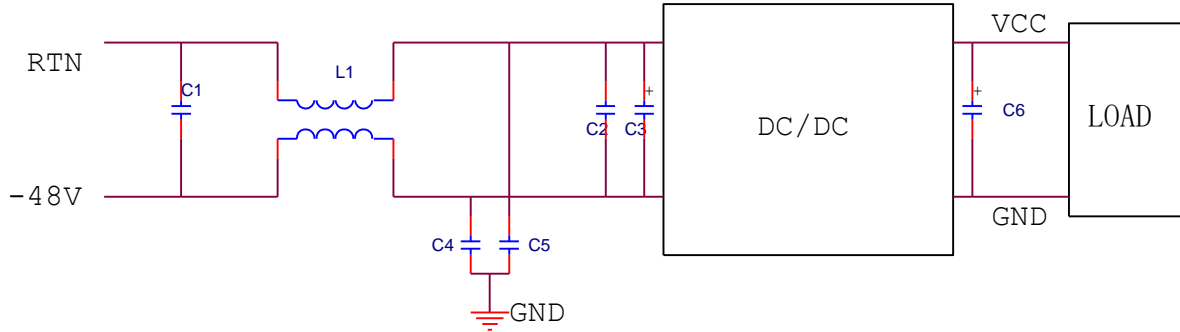

| Item | Reference Designator | Values | Description |
|------|----------------------|--------------|--------------------------|
| 1 | C1 | 1 μ F | SMD/1210 size/100V/X7R |
| 2 | C2 | 100nF | SMD/1206 size/100V/X7R |
| 3 | C4,C5 | 22nF | SMD/1210 size/1000V/X7R |
| 4 | L1 | 1320 μ H | SMD/Common Mode Choke/4A |
| 5 | C3 | 200 μ F | Aluminum Electrolytic |
| 6 | C6 | 0 μ F | Aluminum Electrolytic |

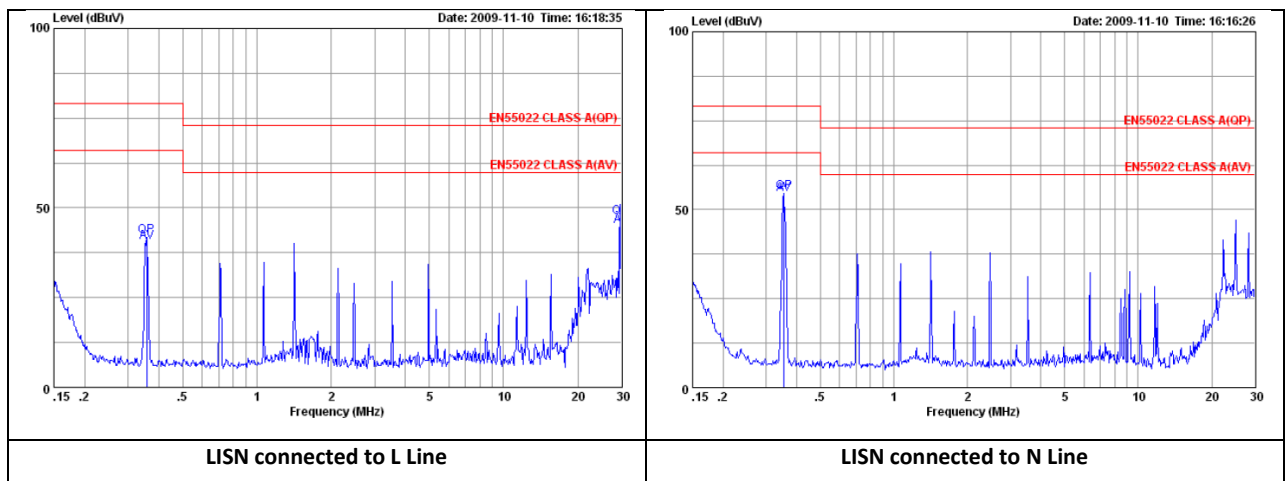

Figure 19. EMC Considerations

ESTW015A0F Series; Eighth Brick Power Modules

36-75Vdc Input; 3.3Vdc, 15A Output

For further information on designing for EMC compliance, please refer to the FLT007A0 data sheet (DS05-028).

Mechanical Outline for Through-Hole Module

Dimensions are in millimeters and [inches].

Tolerances: x.x mm ± 0.5 mm [x.xx in. ± 0.02 in.] (Unless otherwise indicated)

x.xx mm ± 0.25 mm [x.xxx in ± 0.010 in.]

Top side label includes Lineage Power name, product designation and date code.

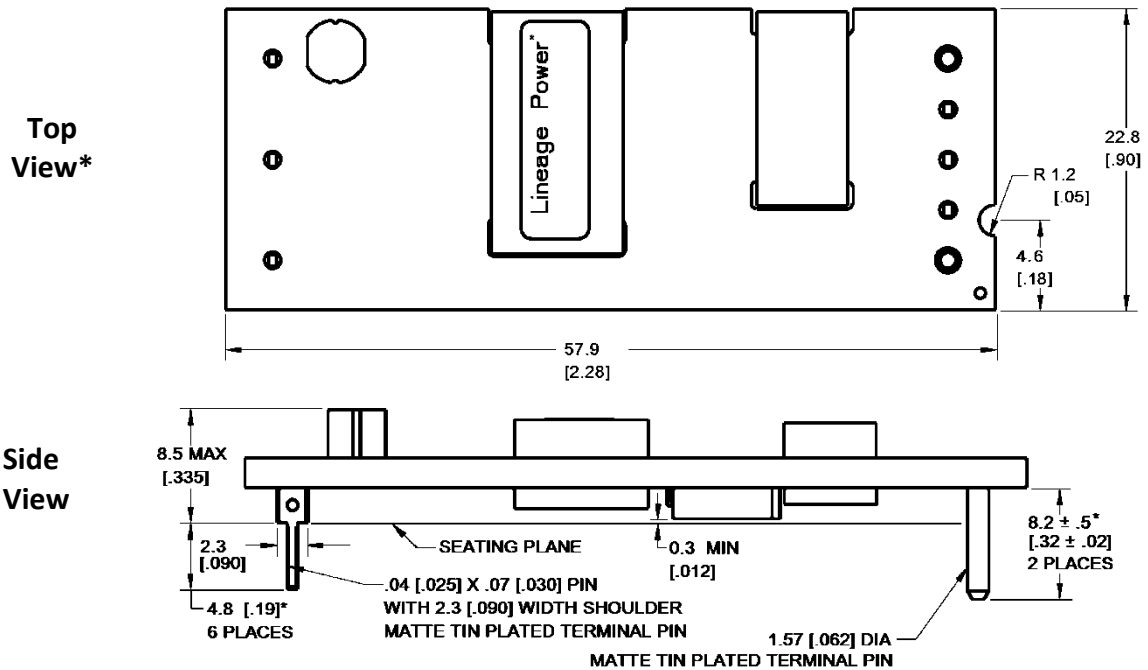

*For optional pin lengths, see Table 2, Device Options

ESTW015A0F Series; Eighth Brick Power Modules

36-75Vdc Input; 3.3Vdc, 15A Output

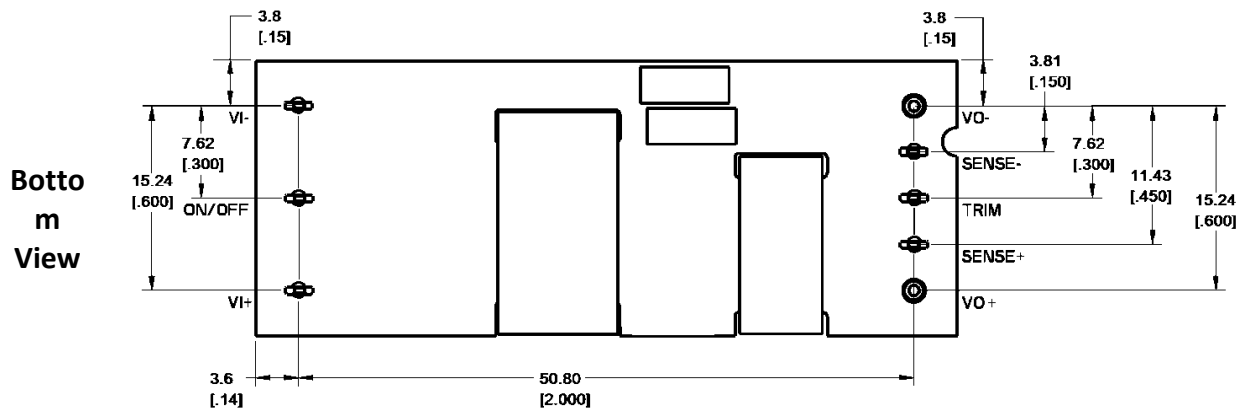

| Pin | Function |
|-----|----------|
| 1 | Vi(+) |
| 2 | ON/OFF |
| 3 | Vi(-) |
| 4 | Vo(-) |
| 5 | SENSE(-) |
| 6 | TRIM |
| 7 | SENSE(+) |
| 8 | Vo(+) |

ESTW015A0F Series; Eighth Brick Power Modules

36-75Vdc Input; 3.3Vdc, 15A Output

Recommended Pad Layout

Dimensions are in millimeters and [inches].

Tolerances: x.x mm ± 0.5 mm [x.xx in. ± 0.02 in.] (Unless otherwise indicated)

x.xx mm ± 0.25 mm [x.xxx in ± 0.010 in.]

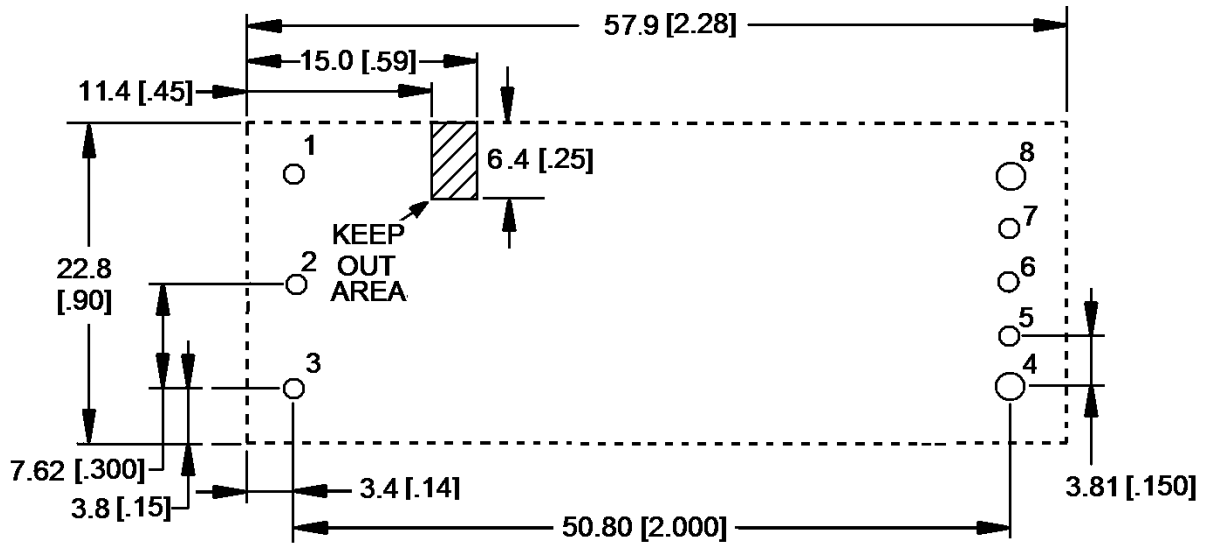

TH Recommended Pad Layout (Component Side View)

ESTW015A0F Series; Eighth Brick Power Modules

36-75Vdc Input; 3.3Vdc, 15A Output

Ordering Information

Please contact your ABB Power Sales Representative for pricing, availability and optional features.

Table 1. Device Codes

| Product Codes | Input Voltage | Output Voltage | Output Current | On/Off Logic | Connector Type | Comcodes |
|-----------------|----------------|----------------|----------------|--------------|----------------|-------------|
| ESTW015A0F41Z | 48V (36-75Vdc) | 3.3V | 15A | Negative | Through hole | CC109158085 |
| ESTW015A0F641-Z | 48V (36-75Vdc) | 3.3V | 15A | Negative | Through hole | CC109159942 |

Table 2. Device Options

| | Characteristic | Character and Position | Definition |
|---------|--------------------------------------|------------------------|---|
| Ratings | Form Factor | E | E = Eighth Brick |
| | Family Designator | ST | ST=STringray Series |
| | Input Voltage | W | W = Wide Range, 36V-75V |
| | Output Current | 015A0 | 015A0 = 015.0 Amps Maximum Output Current |
| | Output Voltage | F | F =3.3V nominal |
| Options | Pin Length | 8 6 | Omit = Default Pin Length shown in Mechanical Outline Figures 8 = Pin Length: 2.79 mm ± 0.25mm , (0.110 in. ± 0.010 in.) 6 = Pin Length: 3.68 mm ± 0.25mm , (0.145 in. ± 0.010 in.) |
| | Action following Protective Shutdown | 4 | Omit = Latching Mode 4 = Auto-restart following shutdown (Overcurrent/Overvoltage) |
| | On/Off Logic | 1 | Omit = Positive Logic 1 = Negative Logic (Standard) |
| | Customer Specific | XY | XY = Customer Specific Modified Code, Omit for Standard Code |
| | Mechnaical Features | | Omit = Standard Open Frame Module with Through Hole Pins |
| | RoHS | | Omit = RoHS 5/6, Lead Based Solder Used Z = RoHS 6/6 Compliant, Lead free |

Contact Us

For more information, call us at

USA/Canada:

+1 888 546 3243, or +1 972 244 9288

Asia-Pacific:

+86-21-53899666

Europe, Middle-East and Africa:

+49.89.878067-280

Go.ABB/Industrial

ABB reserves the right to make changes to the product(s) or information contained herein without notice, and no liability is assumed as a result of their use or application. No rights under any patent accompany the sale of any such product(s) or information.