

IND016 Hornet: Non-Isolated DC-DC Voltage Regulator Modules

12Vdc input; 1.0Vdc to 5.5Vdc output; 16.5W Max Power



Applications

- ✓ Industrial Equipment
- ✓ Control Boards
- ✓ Test Equipment

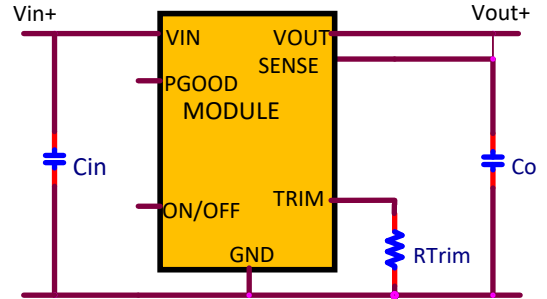

Electrical Features

- 12V Input voltage with up to ±20% Tolerance
- Output voltage programmable from 1.0Vdc to 5.5Vdc via external resistor
- Remote On/Off for optional external control
- Power Good signal for external monitoring
- Fixed switching frequency
- Output overcurrent protection (non-latching)

Mechanical Features

- Small size: 12.2 mm x 12.2 mm x 6.25 mm (0.48 in x 0.48 in x 0.246 in)
- Operating range: -40°C to 105°C ambient
- Operating shock to 40G per Mil Std. 810G, Method 516.4 Procedure I
- Operating vibration per Mil Std. 810G, Method 514.5 Procedure I

Process and Safety

- Qualified for 1000h High Temperature Operating Bias, 1000h 85RH/85°C Temperature, Humidity and Bias, 700 cycle -40 to 125°C thermal cycling
- ANSI/UL* 62368-1 and CAN/CSA† C22.2 No. 62368-1 Recognized, DIN VDE‡ 0868-1/A11:2017 (EN62368-1:2014/A11:2017)
- ISO** 9001 and ISO 14001 certified manufacturing facilities
- Compliant to RoHS Directive 2011/65/EU and amended Directive (EU) 2015/863
- Compliant to REACH Directive (EC) No 1907/2006
- Compatible in a Pb-free or SnPb reflow environment.
- Suitable for aqueous clean.
- Suitable for conformal coating with dip and vapor deposition. Conformal coating can provide the protection to meet Salt Fog Test per IEC 60068-2-52 (Severity 3) and Mixed Gas Flow test per Telcordia GR-3108 Outdoor Levels.
- 3 year warranty

Device Code	Input Voltage	Output Voltage	Output Current (Max.)	On/Off Logic	Comcode
IND016	9.6 – 14.4**Vdc	1.0 – 5.5Vdc	3A	Negative	1600102897A

Thermal Performance

Full rated output with natural convection up to 94°C at 1.2Vout and up to 100°C at 5Vout. Thermal curves for 1.2V, 1.8V and 5Vout below.

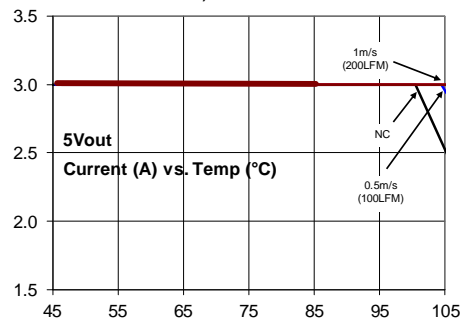
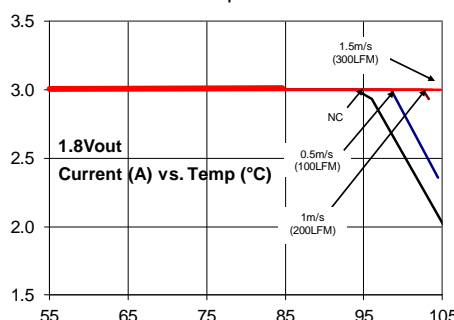
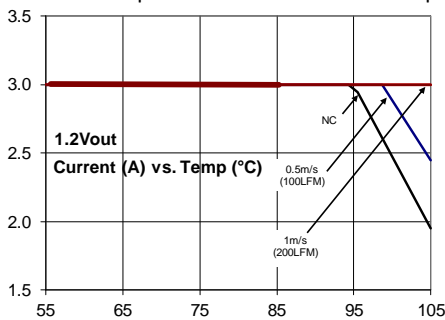

Electrical Specifications

Parameter	Device	Symbol	Min	Typ	Max	Unit
Operating Input Voltage	All	V _{IN}	9.6	12	14.4**	Vdc
Input No Load Current (V _{IN} = 12.0Vdc, I _o = 0, module enabled)	V _{o,set} = 5Vdc	I _{IN,No load}		38		mA
External Capacitance, Ceramic ESR ≥ 1 mΩ	All	C _{o,max}	10	—	22*	μF
Efficiency 12V _{INDC} , T _A =25°C, I=12A, V _o =1.2 to 5Vdc		η	82.8(1.2V), 88.2(1.8V), 91.6(3.3V), 93.8(5V)			%
Switching Frequency	All	f _{sw}	—	600	—	kHz
Output Voltage (Over all line, load, and temperature conditions until end of life)	All	V _{O, set}	-3.0	—	+3.0	% V _{O, set}
On/Off Logic High (MODULE OFF) Input High Voltage	All	V _{IH}	3.0	—	14.4	Vdc
On/ Off Logic Low (MODULE ON) Input Low Voltage	All	V _{IL}	-0.2	—	0.4	Vdc
PGOOD (Power Good) Signal Interface Open Drain, V _{supply} ≤ 5VDC						
Overvoltage threshold for PGOOD				112.5		%V _{O, set}
Undervoltage threshold for PGOOD				87.5		%V _{O, set}
Pulldown resistance of PGOOD pin	All			30		Ω
Sink current capability into PGOOD pin	All				5	mA

*Additional External Capacitance possible using Tunable Loop

** For 1≤V_{out}<1.1, do not exceed 12V_{in}. For 1.1≤V_{out}≤1.2, do not exceed 13V_{in}. For V_{out} >1.2, Input Voltage can be as high as 14.4V

Characteristic Curves

The following figures provide typical characteristics for the IND016 Hornet at 25°C.

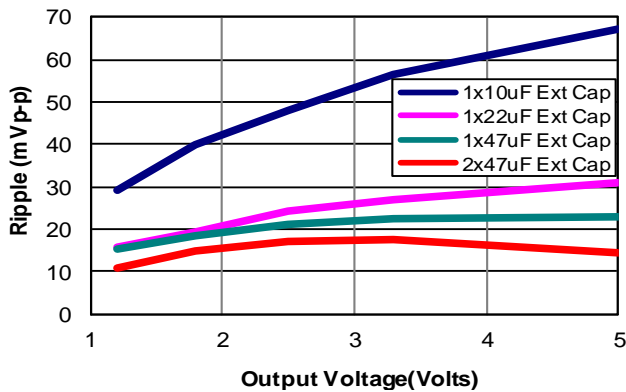

Figure 1. Output Ripple Voltage(20MHz BW) for various output voltages and external caps @12Vin. Additional Decoupling cap of 0.1uF used on input and output side

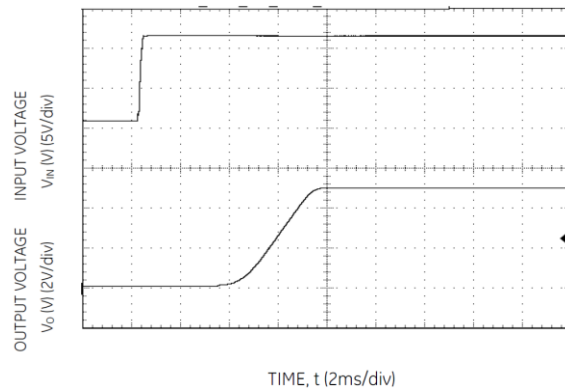

Figure 2. Typical Start-up using Input Voltage (Vin=12V, Vout = Vout, max, Iout = Iout, max)

Trim

Without an external resistor between Trim and GND pins, the output of the module will be 0.6Vdc. R_{trim} for a desired output voltage, should be as per the following table. The formula in the last column helps determine R_{trim} for other voltages.

V _o (V)	1.2	1.5	1.8	2.5	3.3	5.0	$R_{trim} = \left[\frac{12}{(V_o - 0.6)} \right] k\Omega$
R _{trim} (kΩ)	20	13.3	10	6.316	4.4	2.727	

Safety Considerations

For safety agency approval, the power module must be installed in compliance with the spacing and separation requirements of the end-use safety agency standards listed on the first page of this document. For the converter output to be considered meeting the requirements of safety extra-low voltage (SELV) or ES1, the input must meet SELV/ES1 requirements. The power module has

extra-low voltage (ELV) outputs when all inputs are ELV. The input to these units is to be provided with a fast-acting fuse with a maximum rating of 5A, 125VDC in the positive input lead.

Tunable Loop

The module is designed for 1x47uF capacitor on its output. For applications where more than 1x47uF capacitors would be used on the output, an additional Resistor (Rtune) and Capacitor (Ctune) would be required in the circuit schematic to compensate for the additional capacitance. The placement is between the Sense+ pin and Trim pin as per figure below:

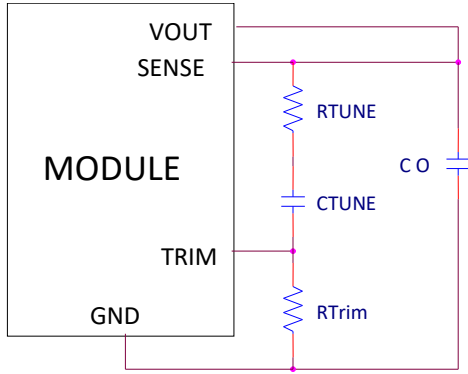

The recommended values for Rtune and Ctune for different amounts of external capacitance are as per the table below:

Co	1x47µF	2x47µF	4x47µF	6x47µF	10x47µF
R _{TUNE}	270	220	180	180	180
C _{TUNE}	1500pF	1800pF	3300pF	4700pF	4700pF

Figure. 3. Circuit diagram showing connection of R_{TUNE} and C_{TUNE} to tune the control loop of the module

PowerGood (PGOOD)

This is an open-drain output to indicate that the output voltage is within the regulation limits of the module. The PGOOD signal will be de-asserted to a low state if any condition such as overtemperature, overcurrent or loss of regulation occurs that would result in the output voltage going ±10% outside the setpoint value. If not used, leave unconnected.

Recommended Pad Layout

Dimensions are in millimeters and (inches).

Tolerances: x.x mm ± 0.5 mm (x.xx in. ± 0.02 in.) [unless otherwise indicated] x.xx mm ± 0.25 mm (x.xxx in ± 0.010 in.)

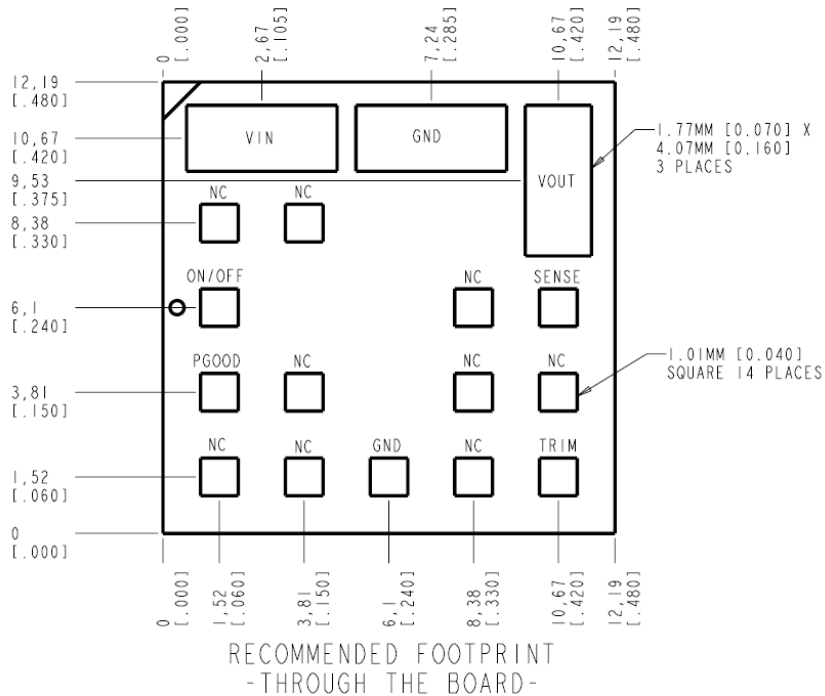

Nozzle Recommendations

The minimum recommended inside nozzle diameter for reliable operation is 3mm. The maximum nozzle outer diameter, which will safely fit within the allowable component spacing, is 7 mm.

Bottom Side / First Side Assembly

This module is not recommended for assembly on the bottom side of a customer board. If such an assembly is attempted, components may fall off the module during the second reflow process

Lead Free Soldering

The modules are lead-free (Pb-free) and RoHS compliant and fully compatible in a Pb-free soldering process. Failure to observe the instructions below may result in the failure of or cause damage to the modules and can adversely affect long-term reliability

MSL Rating

The modules have a MSL rating of 2a.

Pb-free Reflow Profile

Power Systems will comply with J-STD-020 Rev. D (Moisture/Reflow Sensitivity Classification for Nonhermetic Solid State Surface Mount Devices) for both Pb-free solder profiles and MSL classification procedures. The suggested Pb-free solder paste is Sn/Ag/Cu (SAC).

The following profile is the recommended linear reflow profile using Sn/Ag/Cu solder. Soldering outside of the recommended profile requires testing to verify results and performance.

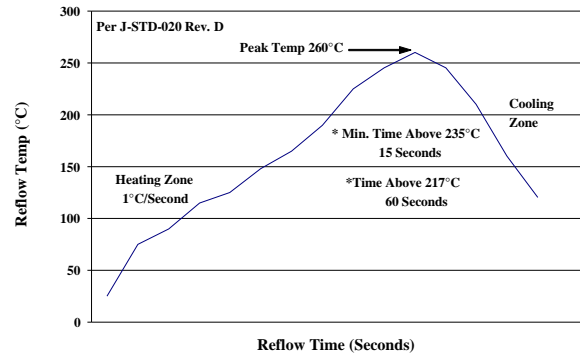

Storage and Handling

J-STD-033 Rev. A (Handling, Packing, Shipping and Use of Moisture/Reflow Sensitive Surface Mount Devices) is recommended. Moisture barrier bags (MBB) with desiccant are required for MSL ratings of 2 or greater. These sealed packages should not be broken until time of use. Once the original package is broken, the floor life of the product at conditions of $\leq 30^{\circ}\text{C}$ and 60% relative humidity varies according to the MSL rating (see J-STD-033A). The shelf life for dry packed SMT packages will be a minimum of 12 months from the bag seal date, when stored at the following conditions: $< 40^{\circ}\text{C}$, $< 90\%$ relative humidity.

Post Solder Cleaning and Drying Considerations

Post solder cleaning is usually the final circuit-board assembly process prior to electrical board testing. The result of inadequate cleaning and drying can affect both the reliability of a power module and the testability of the finished circuit-board assembly

Contact Us

For more information, call us at

USA/Canada:

+1 888 546 3243, or +1 972 244 9288

Asia-Pacific:

+86-21-53899666

Europe, Middle-East and Africa:

+49.89.878067-280

Go.ABB/Industrial



GE Critical Power reserves the right to make changes to the product(s) or information contained herein without notice, and no liability is assumed as a result of their use or application. No rights under any patent accompany the sale of any such product(s) or information.