

## JRCS016 - Non-Isolated DC-DC Buck and Boost Power Modules

18Vdc-85Vdc input 18.5Vdc to 60Vdc output: 400W Max. Output



### Applications

- Transportation applications
- Industrial applications
- Telecommunications equipment

### Features

- Compliant to RoHS Directive 2011/65/EU and amended Directive (EU) 2015/863
- Compliant to REACH Directive (EC) No 1907/2006
- Compliant to IPC-9592 (September 2008), Category 2, Class II
- Wide variable input voltage range (18-85Vdc)
- Programmable output voltage range (18.5-60Vdc)
- Remote sense
- Positive logic remote On/Off
- Output over current protection (non-latching)
- Over temperature protection
- Monotonic startup under pre-bias conditions
- Forced droop load sharing (only -P version)
- Industry standard half-brick size  
57.7 x 60.7 x 12.95 mm (2.27 in. x 2.39 in. x 0.51 in.)
- Wide operating temperature range (-40°C to 85°C)
- Digital (PMBus) Interface
- ANSI/UL# 62368-1 and CAN/CSA† C22.2 No. 62368-1 Recognized, DIN VDE‡ 0868-1/A11:2017 (EN62368-1:2014/A11:2017)
- ISO\*\* 9001 and ISO 14001 certified manufacturing facilities

### Description

The JRCS016 is a versatile non-isolated module capable of delivering output voltages that can be below, equal to or above the input voltage (buck and boost functionality). Over an input voltage range of 18 to 85V, these modules can provide an output voltage that can be set between 18.5V and 60V and output power up to 400W. A variable output current limit that automatically limits the output current depending on the desired output voltage safely limits the output power that can be delivered by the module. Threaded-through holes are provided to allow easy mounting or addition of a heatsink for high-temperature applications. Other features include remote On/Off, adjustable output voltage, over current, and over temperature protection. The modules also have a digital (PMBus™) interface with a rich set of supported commands

\* UL is a registered trademark of Underwriters Laboratories, Inc.

† CSA is a registered trademark of Canadian Standards Association.

‡ VDE is a trademark of Verband Deutscher Elektrotechniker e.V.

\*\* ISO is a registered trademark of the International Organization of Standards

## JRCS016 - Non-Isolated DC-DC Buck and Boost Power Modules

18Vdc-85Vdc input 18.5Vdc to 60Vdc output: 400W Max. Output

### Absolute Maximum Ratings

Stresses in excess of the absolute maximum ratings can cause permanent damage to the device. These are absolute stress ratings only, functional operation of the device is not implied at these or any other conditions in excess of those given in the operations sections of the data sheet. Exposure to absolute maximum ratings for extended periods can adversely affect the device reliability.

Parameter	Device	Symbol	Min	Max	Unit
Input Voltage					
Continuous	All	$V_{IN}$	-0.3	85	Vdc
Transient, for up to 100ms	All		-0.3	100	Vdc
Operating Ambient Temperature (see Thermal Considerations section)	All	$T_A$	-40	85	°C
Storage Temperature	All	$T_{stg}$	-55	125	°C

### Electrical Specifications

Unless otherwise indicated, specifications apply overall operating input voltage, resistive load, and temperature conditions.

Parameter	Device	Symbol	Min	Typ	Max	Unit
Operating Input Voltage	All	$V_{IN}$	18	—	85	Vdc
Maximum Input Current ( $V_{IN} = V_{IN, min}$ to $V_{IN, max}$ , $I_O = I_{O, max}$ )	All	$I_{IN, max}$			26.0	Adc
Input No Load Current ( $V_{IN} = V_{IN, nom}$ , $I_O = 0$ , module enabled)	$V_{O, set} = 18.5Vdc$ $V_{O, set} = 60 Vdc$	$I_{IN, No load}$ $I_{IN, No load}$		70 70		mA mA
Input Stand-by Current ( $V_{IN} = V_{IN, nom}$ , module disabled)	All	$I_{IN, stand-by}$		27		mA
Inrush Transient	All	$I^2t$			0.5	A <sup>2</sup> s
Input Reflected Ripple Current, peak-to-peak (5Hz to 20MHz, 1μH source impedance; $V_{IN, min}$ to $V_{IN, max}$ , $I_O = I_{O, max}$ ; See Test configuration section)	All				700	mAp-p
Input Ripple Rejection (120Hz)	All		10			dB

## JRCS016 - Non-Isolated DC-DC Buck and Boost Power Modules

18Vdc-85Vdc input 18.5Vdc to 60Vdc output: 400W Max. Output

### Electrical Specifications (continued)

Parameter	Device	Symbol	Min	Typ	Max	Unit
Output Voltage Set-point ( $V_{IN}=V_{IN, min}$ , $I_O=I_{O, max}$ , $T_A=25^\circ\text{C}$ )	All	$V_{O, set}$	-1.5	—	+1.5	% $V_{O, set}$
Output Voltage (Overall operating input voltage, resistive load, and temperature conditions until end of life)	All	$V_{O, set}$	-3	—	+3	% $V_{O, set}$
Output Voltage Adjustment Range		$V_O$	18.5		60	Vdc
Output Regulation Line ( $V_{IN}=V_{IN, min}$ to $V_{IN, max}$ ) Load ( $I_O=I_{O, min}$ to $I_{O, max}$ ) Temperature ( $T_{ref}=T_{A, min}$ to $T_{A, max}$ )	All All All		— — —		1 0.4 1	% $V_{O, set}$ % $V_{O, set}$ % $V_{O, set}$
Output Ripple and Noise on nominal output ( $V_{IN}=V_{IN, nom}$ and $I_O=I_{O, min}$ to $I_{O, max}$ Cout = 340 $\mu\text{F}$ Polymer aluminum) RMS (5Hz to 20MHz bandwidth) Peak-to-Peak (5Hz to 20MHz bandwidth)	All All		— —		1 2	% $V_{O, set}$ % $V_{O, set}$
External Capacitance ESR $\geq 1\text{ m}\Omega$ (with minimum of 30 $\mu\text{F}$ of ceramic capacitors) ESR $\geq 10\text{ m}\Omega$ ((with minimum of 30 $\mu\text{F}$ of ceramic capacitors)	All All	$C_{O, max}$ $C_{O, max}$	330 330	— —	3000 3000	$\mu\text{F}$ $\mu\text{F}$
Output Current ( $V_O=18.5\text{V}$ ) ( $V_O=24\text{V}$ ) ( $V_O=48\text{V}$ ) ( $V_O=60\text{V}$ )	All All All All	$I_O$ $I_O$ $I_O$ $I_O$	0 0 0 0		16.7A 16.7A 8.33A 6.67A	Adc Adc Adc Adc
Output Current Limit Inception (Hiccup Mode) ( $V_O=90\%$ of $V_{O, set}$ )	All	$I_{O, lim}$	—	110	—	% $I_O$
Output Short-Circuit Current ( $V_O \leq 250\text{mV}$ ) (Hiccup Mode)	All	$I_{O, s/c}$	—	2.0	—	Arms
Efficiency, $V_{IN}=74\text{V}$ , $T_A=25^\circ\text{C}$ , $I_O=I_{O, max}$ , $V_O=V_{O, set}$ $V_{O, set}=52\text{Vdc}$	All	$\eta$	95			%
Switching Frequency	All	$f_{sw}$	—	220	—	kHz

## JRCS016 - Non-Isolated DC-DC Buck and Boost Power Modules

### 18Vdc-85Vdc input 18.5Vdc to 60Vdc output: 400W Max. Output

#### General Specifications

Parameter	Min	Typ	Max	Unit
Calculated MTBF ( $I_o=I_{o,max}$ , $T_A=25^\circ\text{C}$ )	19,173,816			Hours
Weight	—	112 (3.95)	—	g (oz.)

#### Feature Specifications

Unless otherwise indicated, specifications apply overall operating input voltage, resistive load, and temperature conditions. See Feature Descriptions for additional information.

Parameter	Device	Symbol	Min	Typ	Max	Unit
On/Off Signal interface  (On/Off is open collector/drain logic input; Signal referenced to GND - See feature description section)						
Input High Voltage (Module ON)	All	$V_{IH}$	2	—	3.3	V
Input High Current	All	$I_{IH}$	—	—	100	$\mu\text{A}$
Input Low Voltage (Module OFF)	All	$V_{IL}$	-0.2	—	0.8	V
Input Low Current	All	$I_{IL}$	—	—	500	$\mu\text{A}$
Turn-On Delay and Rise Times ( $I_o=I_{o,max}$ , $V_{IN}=V_{IN,nom}$ , $T_A=25^\circ\text{C}$ , )						
Case 1: On/Off input is set to Logic Low (Module ON) and then input power is applied (delay from instant at which $V_{IN}=V_{IN,min}$ until $V_o=10\%$ of $V_{o,set}$ )	All	Tdelay	—	90	—	msec
Case 2: Input power is applied for at least one second and then the On/Off input is set to logic Low (delay from instant at which $V_{on/Off}=0.3\text{V}$ until $V_o=10\%$ of $V_{o,set}$ )	All	Tdelay	—	50	—	msec
Output voltage Rise slew rate	All	$dv/dt_{rise}$	—	0.333	0.4	V/msec
Load Sharing Current Balance (difference in output current across all modules compared to defined output current.) (-P version only)  Note: 1) Results are based on 3 units in parallel, and $ V_{out}-V_{in}  > 6\text{V}$ . If the difference between $V_{in}$ and $V_{out}$ is close, paralleled performance will decrease. 2) Current sharing accuracy depends on test setup, such as test board layout, connection wires, etc... besides module self. 4) $V_{out,max}$ need to be limited to 58V if the units work in paralleling. 5) For 48V output, need limit to max 80% of full load. 6) For 54V output, need limit to max 75% of full load. 6) The difference between input and output voltage need be over 6V to get better paralleled performance.	20Vout	Idiff	—	—	3	Adc
	28Vout		—	—	2	Adc
	36Vout		—	—	2	Adc
	48Vout		—	—	2.5	Adc
Output voltage overshoot - Startup $I_o=I_{o,max}$ ; $V_{IN}=18$ to 85Vdc, $T_A=25^\circ\text{C}$				—	5	% $V_{o,set}$
Over Temperature Protection (See Thermal Considerations section)	All	$T_{ref}$	—	120	—	$^\circ\text{C}$
Input Undervoltage Lockout						
Turn-on Threshold	All				18	V
Turn-off Threshold	All		15			V
PGOOD (Power Good) Signal Interface Open Drain, $V_{supply} \leq 5\text{VDC}$						
Overshoot threshold for PGOOD	All			112.5		% $V_{o,set}$
Undervoltage threshold for PGOOD	All			87.5		% $V_{o,set}$

# JRCS016 - Non-Isolated DC-DC Buck and Boost Power Modules

18Vdc-85Vdc input 18.5Vdc to 60Vdc output: 400W Max. Output

## Characteristic Curves

The following figures provide typical characteristics for the JRCS011 at 24Vo and 25oC.

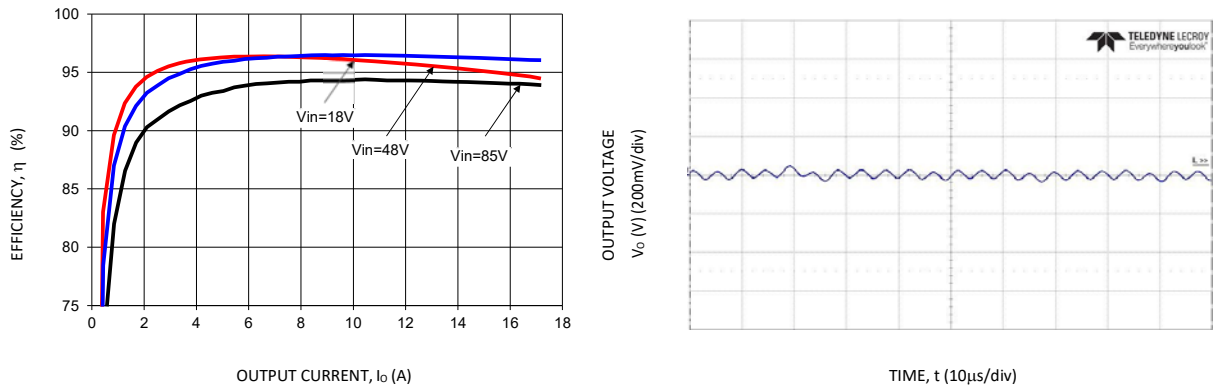

Figure 1. Converter Efficiency versus Output Current for  $V_{out} = 24V$ . Figure 2. Typical output ripple and noise for  $V_{out} = 24V$ . Input voltage = 48V,  $C_{out} = 330\mu F$  electrolytic +  $15 \times 2.2\mu F$  ceramic.

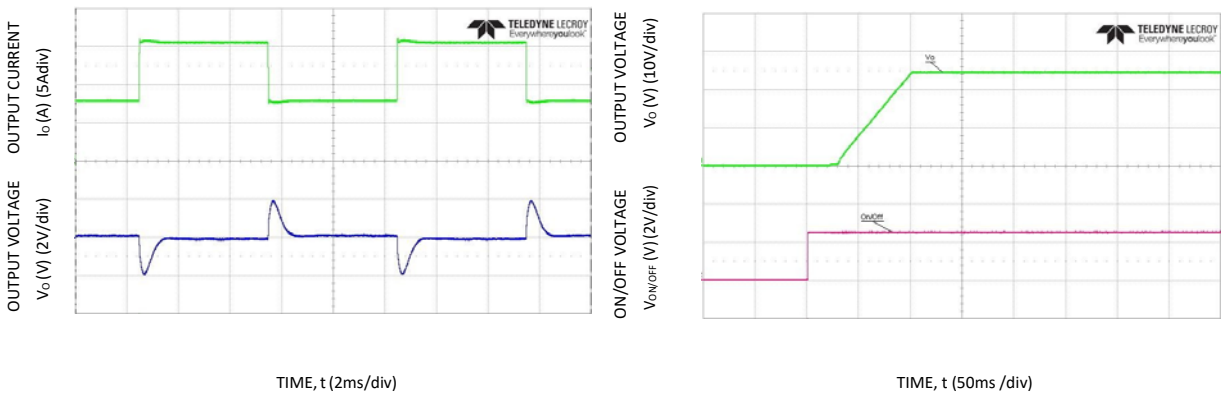

Figure 3. Transient Response to Dynamic Load Change from 50% to 100% at 48Vin,  $C_{out} = 330\mu F$  electrolytic +  $15 \times 2.2\mu F$  ceramic.

Figure 4. Typical Start-up Using On/Off Voltage ( $V_{IN} = 48V$ ,  $I_o = I_{o,max}$ ).

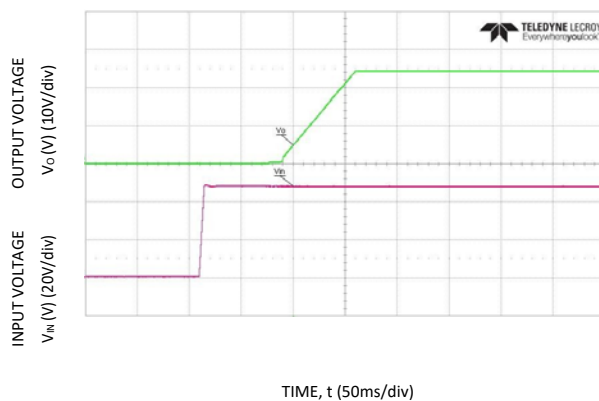

Figure 5. Typical Start-up Using Input Voltage ( $V_{IN} = 48V$ ,  $I_o = I_{o,max}$ ).

# JRCS016: Non-Isolated DC-DC Power Modules

18Vdc-85Vdc input 18.5Vdc to 60Vdc output: 400W Max. Output

## Characteristic Curves

The following figures provide typical characteristics for the JRCS011 at 48Vo and 25oC.

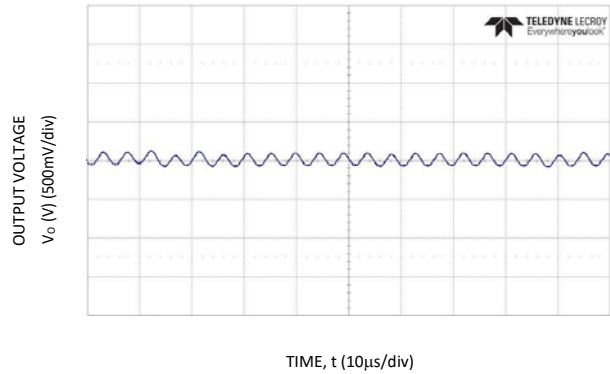
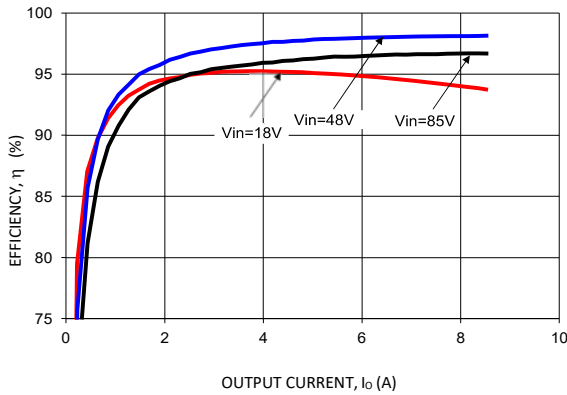

**Figure 6. Converter Efficiency versus Output Current for  $V_{out} = 48V$ .** **Figure 7. Typical output ripple and noise for  $V_{out} = 48V$ . Input voltage = 74V,  $C_{OUT} = 330 \mu F$  electrolytic + 15 x 2.2  $\mu F$  ceramic.**

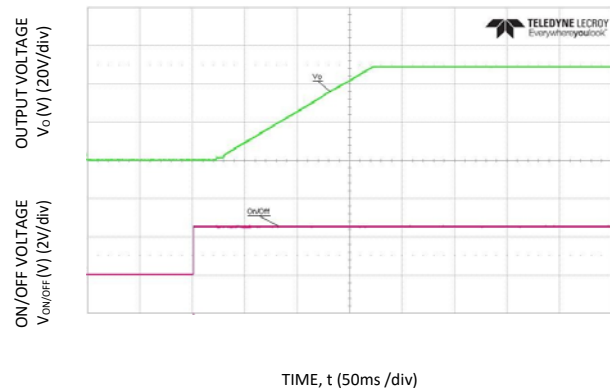
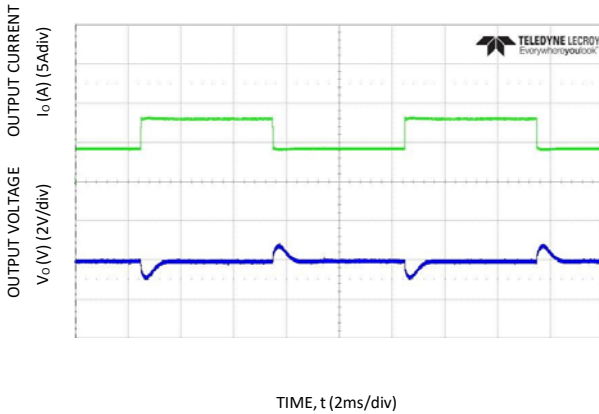

**Figure 8. Transient Response to Dynamic Load Change from 50% to 100% at 74Vin,  $C_{OUT} = 330 \mu F$  electrolytic + 15 x 2.2  $\mu F$  ceramic.** **Figure 9. Typical Start-up Using On/Off Voltage ( $V_{IN}=74V$ ,  $I_o = I_{o,max}$ ).**

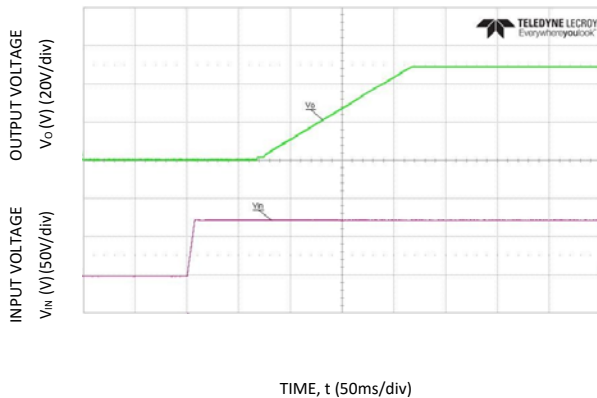

**Figure 10. Typical Start-up Using Input Voltage ( $V_{IN} = 74V$ ,  $I_o = I_{o,max}$ ).**

# JRCS016: Non-Isolated DC-DC Power Modules

18Vdc-85Vdc input 18.5Vdc to 60Vdc output: 400W Max. Output

## Characteristic Curves

The following figures provide typical characteristics for the JRCS011 at 60Vo and 25oC.

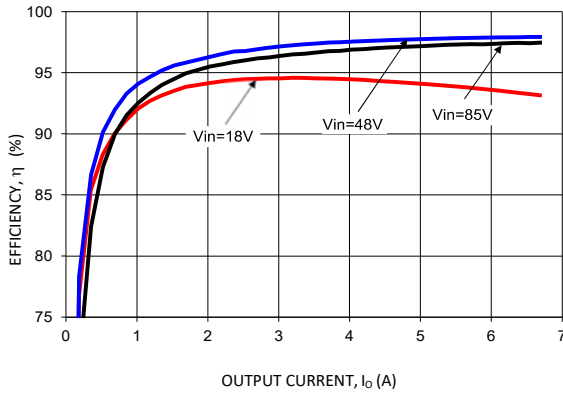

Figure 11. Converter Efficiency versus Output Current for  $V_{out} = 60V$ .

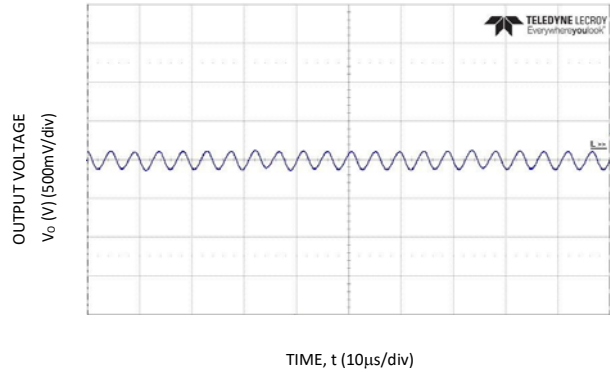

Figure 12. Typical output ripple and noise for  $V_{out} = 60V$ . Input voltage = 48V,  $C_{OUT} = 330\mu F$  electrolytic + 15 x 2.2µF ceramic.

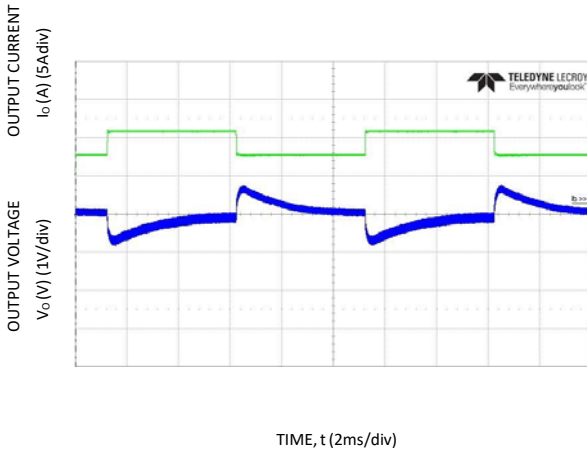

Figure 13. Transient Response to Dynamic Load Change from 50% to 100% at 48Vin,  $C_{out} = 330\mu F$  electrolytic + 15 x 2.2µF ceramic.

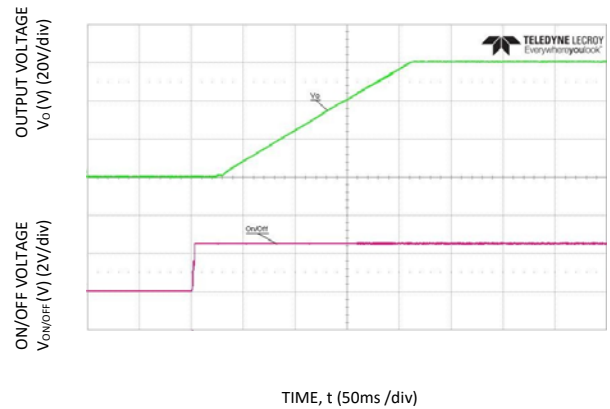

Figure 14. Typical Start-up Using On/Off Voltage ( $V_{IN} = 48V$ ,  $I_o = I_{o,max}$ ).

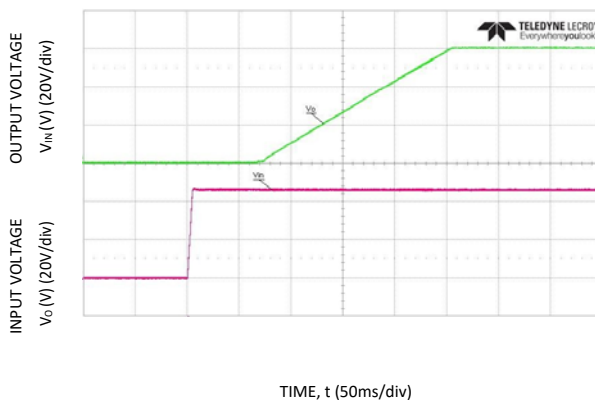

Figure 15. Typical Start-up Using Input Voltage ( $V_{IN} = 48V$ ,  $I_o = I_{o,max}$ ).

## JRCS016: Non-Isolated DC-DC Power Modules

18Vdc-85Vdc input 18.5Vdc to 60Vdc output: 400W Max. Output

The following figures provide typical thermal derating for the JRCS011 at various input and output voltages.

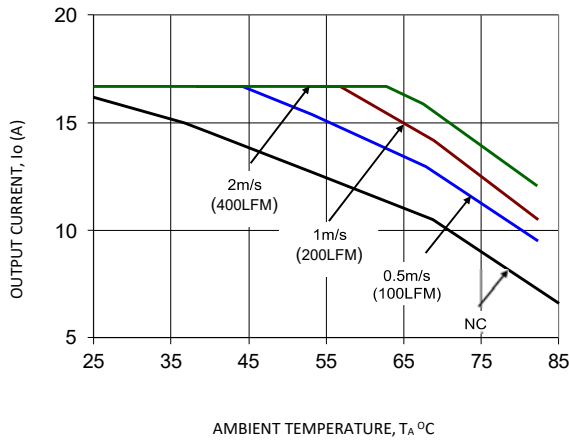

Figure 16. Derating Output Current versus Ambient Temperature and Airflow for  $V_{in}=48V$ ,  $V_{out}=24V$

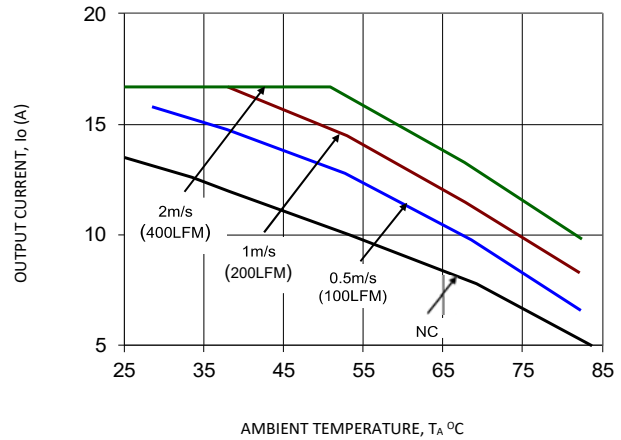

Figure 17. Derating Output Current versus Ambient Temperature and Airflow for  $V_{in}=74V$ ,  $V_{out}=24V$

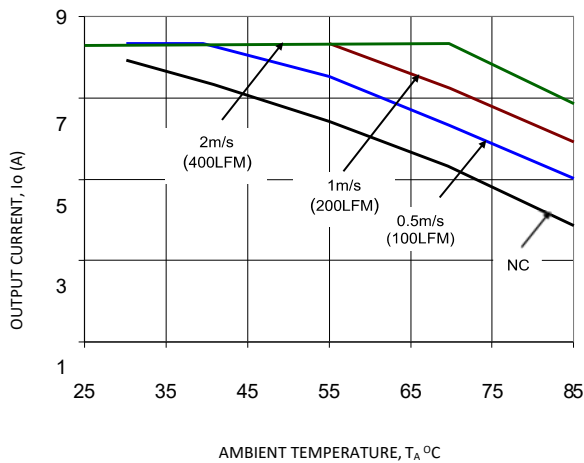

Figure 18. Derating Output Current versus Ambient Temperature and Airflow for  $V_{in}=24V$ ,  $V_{out}=48V$

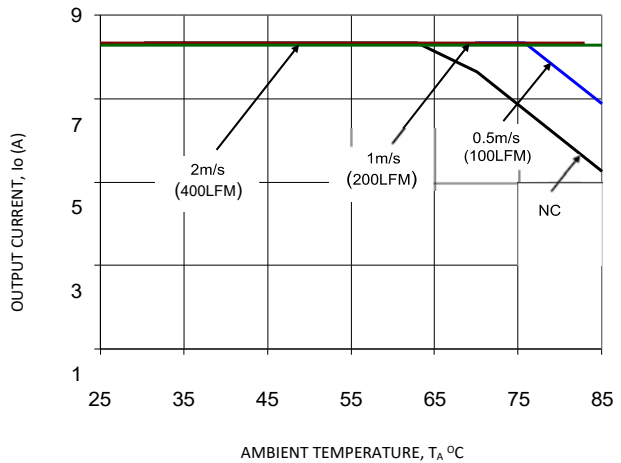

Figure 19. Derating Output Current versus Ambient Temperature and Airflow for  $V_{in}=74V$ ,  $V_{out}=48V$

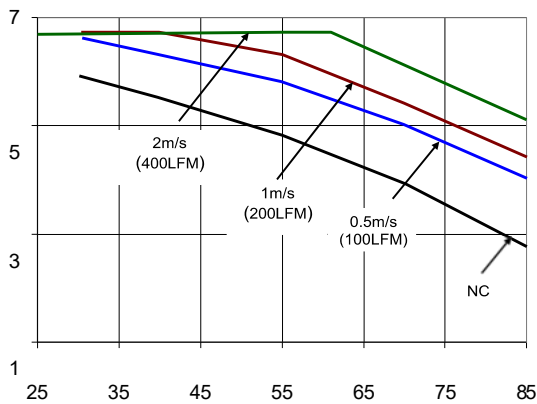

Figure 20. Derating Output Current versus Ambient Temperature and Airflow for  $V_{in}=24V$ ,  $V_{out}=60V$

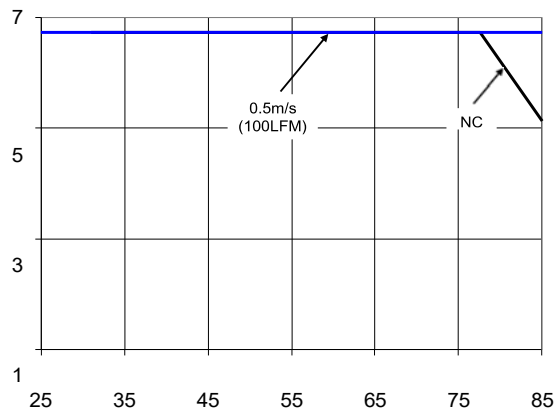

Figure 21. Derating Output Current versus Ambient Temperature and Airflow for  $V_{in}=48V$ ,  $V_{out}=60V$



**JRCS016: Non-Isolated DC-DC Power Modules**

18Vdc-85Vdc input 18.5Vdc to 60Vdc output: 400W Max. Output

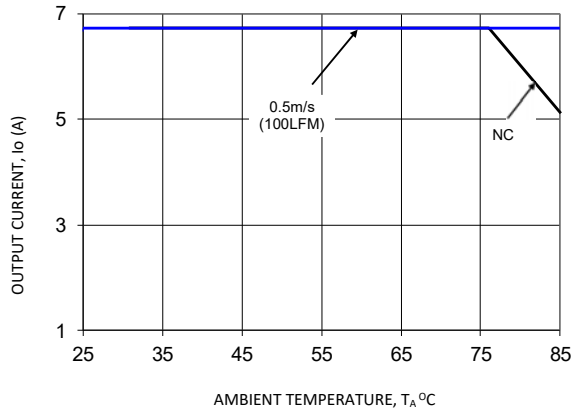
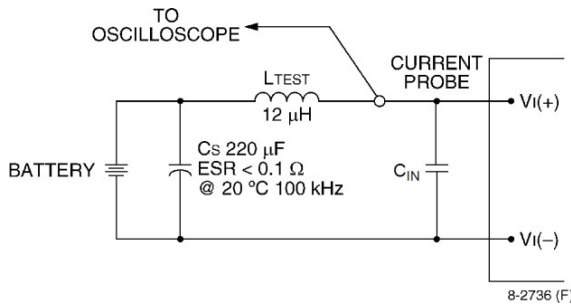

Figure 22. Derating Output Current versus Ambient Temperature and Airflow for  $V_{in}=74V$ ,  $V_{out}=60V$

## JRCS016: Non-Isolated DC-DC Power Modules

18Vdc-85Vdc input 18.5Vdc to 60Vdc output: 400W Max. Output

### Test Configurations



Note: Measure the input reflected-ripple current with a simulated source inductance (LTEST) of 12 µH. Capacitor CS offsets possible battery impedance. Measure the current, as shown above.

Figure 23. Input Reflected-Ripple Current Test Setup.

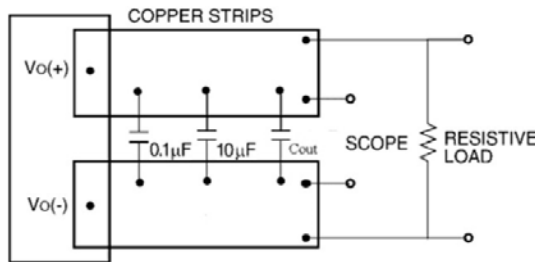

Note: Use a Cout (470 µF Low ESR aluminum or tantalum capacitor typical), a 0.1 µF ceramic capacitor and a 10 µF ceramic capacitor, and Scope measurement should be made using a BNC socket. Position the load between 51 mm and 76 mm (2 in. and 3 in.) from the module.

Figure 24. Output Ripple and Noise Test Setup.

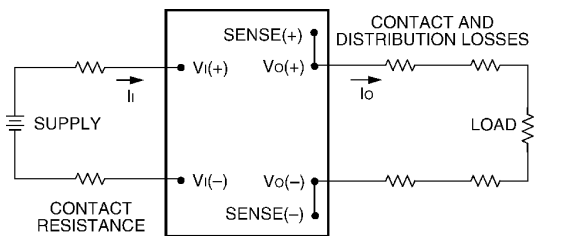

Note: All measurements are taken at the module terminals. When socketing, place Kelvin connections at module terminals to avoid measurement errors due to socket contact resistance.

$$\eta = \left( \frac{[V_{O(+)} - V_{O(-)}]I_{O}}{[V_{I(+)} - V_{I(-)}]I_{I}} \right) \times 100 \%$$

Figure 25. Output Voltage and Efficiency Test Setup.

### Design Considerations

#### Input Filtering

The JRCS016 module should be connected to a low ac-impedance source. A highly inductive source can affect the stability of the module. An input capacitance must be placed directly adjacent to the input pin of the module, to minimize input ripple voltage and ensure module stability. To minimize input voltage ripple, ceramic capacitors or low-ESR electrolytic capacitors are recommended at the input of the module.

#### Output Filtering

These modules are designed for low output ripple voltage and will meet the maximum output ripple specification with 3 x 10µF ceramic capacitors in parallel with a 330µF capacitor at the output of the module. However, additional output filtering may be required by the system designer for a number of reasons. First, there may be a need to further reduce the output ripple and noise of the module. Second, the dynamic response characteristics may need to be customized to a particular load step change.

To reduce the output ripple and improve the dynamic response to a step load change, additional capacitance at the output can be used. Low ESR electrolytic and ceramic capacitors are recommended to improve the dynamic response of the module. For stable operation of the module, limit the capacitance to less than the maximum output capacitance as specified in the electrical specification table.

### Safety Considerations

For safety agency approval the power module must be installed in compliance with the spacing and separation requirements of the end-use safety agency standards, i.e.,

UL ANSI/UL\* 62368-1 and CAN/CSA+ C22.2 No. 62368-1 Recognized, DIN VDE 0868-1/A11:2017 (EN62368-1:2014/A11:2017)

For the converter output to be considered meeting the requirements of safety extra-low voltage (SELV) or ES1, the input must meet SELV/ES1 requirements. The power module has extra-low voltage (ELV) outputs when all inputs are ELV.

The input to these units is to be provided with a slow-blow fuse with a maximum rating of TBD A in the positive input lead.

## JRCS016: Non-Isolated DC-DC Power Modules

18Vdc-85Vdc input 18.5Vdc to 60Vdc output: 400W Max. Output

### Feature Descriptions

#### Remote On/Off

The JRCS016 power modules feature an On/Off pin for remote On/Off operation with positive logic. Positive Logic On/Off signal turns the module ON during a logic High on the On/Off pin and turns the module OFF during a logic Low.

#### Overcurrent Protection

To provide protection in a fault (output overload) condition, the unit is 17\*24 equipped with internal current-limiting circuitry and can endure current limiting continuously. At the point of current-limit inception, the unit enters hiccup mode. The unit operates normally once the output current is brought back into its specified range. The current limit threshold is variable ranging from 16.7 A at 18.5V to 24V out to 6.67A at 60Vout.

#### Input Undervoltage Lockout

At input voltages below the input undervoltage lockout limit, module operation is disabled. The module begins to operate at an input voltage above the undervoltage lockout turn-on threshold.

#### Overtemperature Protection

To provide over temperature protection in a fault condition, the unit shuts down if the thermal reference point  $T_{ref}$ , exceeds 120oC. The module automatically restarts after it cools down.

#### Analog Output Voltage Programming

The output voltage of the JRCS016 can be set over the 18.5V to 60V range by connecting a resistor  $R_{trim}$  between the TRIM and VO(-) pins as shown in Fig. 26. The output voltage will be set according to the following equation relating it to the value of  $R_{trim}$ :

$$R_{trim} = \left[ \frac{700 - (10 \times V_o)}{V_o - 4} \right] k\Omega$$

If no external trim resistor is connected, the output voltage will be set at 18.5. Table 1 provides  $R_{trim}$  values required for some common output voltages.

#### Remote Sense

The JRCS016 modules have a Remote Sense feature to minimize the effects of distribution losses by regulating the voltage at the Remote Sense pins. The voltage between the VO(+) and +SEN pins should not exceed 1V.

Table 1

$V_o, set (V)$	$R_{trim} (K\Omega)$
18.5	35.51
20	31.25
24	23.0
28	17.5
32	13.571
36	10.625
48	5.0
52	3.75
54	3.2
60	1.786

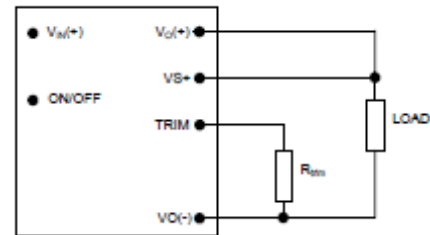

Figure 26. Circuit configuration for programming output voltage using an external resistor.

#### Load Sharing

For higher power requirements, the JRCS016-P module offers an optional feature for parallel operation (-P Option code). This feature provides a precise forced output voltage load regulation droop characteristic. The output set point and droop slope are factory calibrated to ensure optimum matching of multiple modules' load regulation characteristics. To implement load sharing, the following requirements should be followed:

- The VOUT(+) and VOUT(-) pins of all parallel modules must be connected together. Balance the trace resistance for each module's path to the output power planes, to ensure best load sharing and operating temperature balance.
- It is permissible to use a common Remote On/Off signal to start all modules in parallel.
- During system startup with over one module, the load cannot be beyond 100% load of single module due to load unbalance during startup process.
- If fault tolerance is desired in parallel applications, output ORing devices should be used to prevent a single module failure from collapsing the load bus.

## JRCS016: Non-Isolated DC-DC Power Modules

18Vdc-85Vdc input 18.5Vdc to 60Vdc output: 400W Max. Output

### Power Good

The JRCS016 modules have a Power Good (PGOOD) signal that is implemented with an open-drain output to indicate that the output voltage is within the regulation limits of the power module. The PGOOD signal will be de-asserted to a low state if any condition such as overtemperature, overcurrent or loss of regulation occurs that would result in the output voltage going  $\pm 10\%$  outside the setpoint value. The PGOOD terminal can be connected through a pullup resistor (suggested value 100K) to a source of TBD VDC or lower.

For power supplies operating in parallel with their outputs not isolated from each other (e.g., with OR'ing FETs), the PGOOD signal indicates that the common output bus has the expected output voltage and does not provide an indication on any one particular power supply.

## JRCS016: Non-Isolated DC-DC Power Modules

18Vdc-85Vdc input 18.5Vdc to 60Vdc output: 400W Max. Output

### Digital Feature Descriptions

#### PMBus Interface Capability

The JRCS016 power modules have a PMBus interface that supports both communication and control. The PMBus Power Management Protocol Specification can be obtained from [www.pmbus.org](http://www.pmbus.org). The modules support a subset of version 1.1 of the specification (see Table 6 for a list of the specific commands supported). Most module parameters can be programmed using PMBus and stored as defaults for later use.

All communication over the module PMBus interface must support the Packet Error Checking (PEC) scheme. The PMBus master must generate the correct PEC byte for all transactions and check the PEC byte returned by the module.

The module has non-volatile memory that is used to store configuration settings. Not all settings programmed into the device are automatically saved into this non-volatile memory, only those specifically identified as capable of being stored can be saved (see Table 6 for which command parameters can be saved to non-volatile storage).

When one of the paralleled units is powered down, PMBus communication will stop or abnormal.

#### PMBus Data Format

For commands that set thresholds, voltages or report such quantities, the module supports the "Linear" data format among the three data formats supported by PMBus. The Linear Data Format is a two byte value with an 11-bit, two's complement mantissa and a 5-bit, two's complement exponent. The format of the two data bytes is shown below:

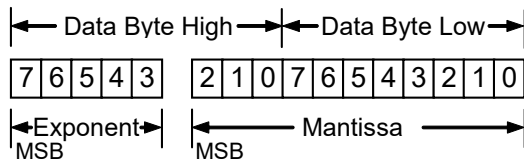

The value of the number is then given by

$$\text{Value} = \text{Mantissa} \times 2^{\text{Exponent}}$$

#### PMBus Addressing

The power module can be addressed through the PMBus using a device address. The module has 64 possible addresses (0 to 63 in decimal) which can be set using resistors connected from the ADDR0 and ADDR1 pins to GND. Note that some of these addresses (0 through 12, 40, 44, 45, and 55 in decimal) are reserved according to the SMBus specifications and may not be useable. The address is set in the form of two octal (0 to 7) digits, with each pin setting one digit. The ADDR1 pin sets the high order digit and ADDR0 sets the low order digit. The resistor values suggested for each digit are shown in Table 2 (1% tolerance resistors are recommended).

Table 2

Digit	Resistor Value (KΩ)
0	10
1	15.4
2	23.7
3	36.5
4	54.9
5	84.5
6	130
7	200

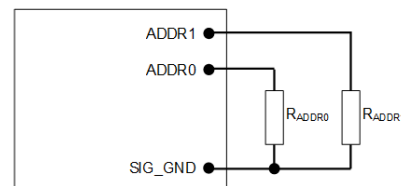

Figure 27. Circuit showing connection of resistors used to set the PMBus address of the module.

The user must know which I2C addresses are reserved in a system for special functions and set the address of the module to avoid interfering with other system operations. Both 100kHz and 400kHz bus speeds are supported by the module. Connection for the PMBus interface should follow the High-Power DC specifications given in section 3.1.3 in the SMBus specification V2.0 for the 400kHz bus speed or the Low Power DC specifications in section 3.1.2. The complete SMBus specification is available from the SMBus web site, [www.pmbus.org](http://www.pmbus.org).

## JRCS016: Non-Isolated DC-DC Power Modules

18Vdc-85Vdc input 18.5Vdc to 60Vdc output: 400W Max. Output

### PMBus Commands

Table 6

Hex Code	Command	Brief Description	Non-Volatile Memory Storage																																																																																	
03	CLEAR_FAULTS	Clear any fault bits that may have been set, also releases the SMBALERT# signal if the device has been asserting it.																																																																																		
11	STORE_DEFAULT_ALL	Copies all current register settings in the module into non-volatile memory (EEPROM) on the module. Takes about 50ms for the command to execute.																																																																																		
12	RESTORE_DEFAULT_ALL	Restores all current register settings in the module from values in the module non-volatile memory (EEPROM)																																																																																		
20	VOUT_MODE	<p>The module has MODE set to Linear and Exponent set to -8. These values cannot be changed</p> <table border="1"> <thead> <tr> <th>Bit Position</th> <th>7</th> <th>6</th> <th>5</th> <th>4</th> <th>3</th> <th>2</th> <th>1</th> <th>0</th> </tr> </thead> <tbody> <tr> <td>Access</td> <td>r</td> <td>r</td> <td>r</td> <td>r</td> <td>r</td> <td>r</td> <td>r</td> <td>r</td> </tr> <tr> <td>Function</td> <td colspan="4">Mode</td> <td colspan="4">Exponent</td> </tr> <tr> <td>Default Value</td> <td>0</td> <td>0</td> <td>0</td> <td>1</td> <td>1</td> <td>0</td> <td>0</td> <td>0</td> </tr> </tbody> </table>	Bit Position	7	6	5	4	3	2	1	0	Access	r	r	r	r	r	r	r	r	Function	Mode				Exponent				Default Value	0	0	0	1	1	0	0	0																																														
Bit Position	7	6	5	4	3	2	1	0																																																																												
Access	r	r	r	r	r	r	r	r																																																																												
Function	Mode				Exponent																																																																															
Default Value	0	0	0	1	1	0	0	0																																																																												
28	VOUT_DROOP	<p>Range limits (max/min): 50.0/0            Units: 16mv/A            DEFAULT VALUE: 5.0 (with -P)</p>																																																																																		
35	VIN_ON	<p>Sets the value of input voltage at which the module turns on</p> <table border="1"> <thead> <tr> <th>Format</th> <th colspan="8">Linear, two's complement binary</th> </tr> </thead> <tbody> <tr> <td>Bit Position</td> <td>7</td> <td>6</td> <td>5</td> <td>4</td> <td>3</td> <td>2</td> <td>1</td> <td>0</td> </tr> <tr> <td>Access</td> <td>r</td> <td>r</td> <td>r</td> <td>r</td> <td>r</td> <td>r</td> <td>r</td> <td>r</td> </tr> <tr> <td>Function</td> <td colspan="4">Exponent</td> <td colspan="4">Mantissa</td> </tr> <tr> <td>Default Value</td> <td>1</td> <td>1</td> <td>1</td> <td>0</td> <td>1</td> <td>0</td> <td>0</td> <td>0</td> </tr> <tr> <td>Bit Position</td> <td>7</td> <td>6</td> <td>5</td> <td>4</td> <td>3</td> <td>2</td> <td>1</td> <td>0</td> </tr> <tr> <td>Access</td> <td>r</td> <td>r/w</td> <td>r/w</td> <td>r/w</td> <td>r/w</td> <td>r/w</td> <td>r/w</td> <td>r/w</td> </tr> <tr> <td>Function</td> <td colspan="8">Mantissa</td> </tr> <tr> <td>Default Value</td> <td>1</td> <td>0</td> <td>0</td> <td>0</td> <td>1</td> <td>0</td> <td>0</td> <td>0</td> </tr> </tbody> </table>	Format	Linear, two's complement binary								Bit Position	7	6	5	4	3	2	1	0	Access	r	r	r	r	r	r	r	r	Function	Exponent				Mantissa				Default Value	1	1	1	0	1	0	0	0	Bit Position	7	6	5	4	3	2	1	0	Access	r	r/w	r/w	r/w	r/w	r/w	r/w	r/w	Function	Mantissa								Default Value	1	0	0	0	1	0	0	0	YES
Format	Linear, two's complement binary																																																																																			
Bit Position	7	6	5	4	3	2	1	0																																																																												
Access	r	r	r	r	r	r	r	r																																																																												
Function	Exponent				Mantissa																																																																															
Default Value	1	1	1	0	1	0	0	0																																																																												
Bit Position	7	6	5	4	3	2	1	0																																																																												
Access	r	r/w	r/w	r/w	r/w	r/w	r/w	r/w																																																																												
Function	Mantissa																																																																																			
Default Value	1	0	0	0	1	0	0	0																																																																												
36	VIN_OFF	<p>Sets the value of input voltage at which the module turns off</p> <table border="1"> <thead> <tr> <th>Format</th> <th colspan="8">Linear, two's complement binary</th> </tr> </thead> <tbody> <tr> <td>Bit Position</td> <td>7</td> <td>6</td> <td>5</td> <td>4</td> <td>3</td> <td>2</td> <td>1</td> <td>0</td> </tr> <tr> <td>Access</td> <td>r</td> <td>r</td> <td>r</td> <td>r</td> <td>r</td> <td>r</td> <td>r</td> <td>r</td> </tr> <tr> <td>Function</td> <td colspan="4">Exponent</td> <td colspan="4">Mantissa</td> </tr> <tr> <td>Default Value</td> <td>1</td> <td>1</td> <td>1</td> <td>0</td> <td>1</td> <td>0</td> <td>0</td> <td>0</td> </tr> <tr> <td>Bit Position</td> <td>7</td> <td>6</td> <td>5</td> <td>4</td> <td>3</td> <td>2</td> <td>1</td> <td>0</td> </tr> <tr> <td>Access</td> <td>r</td> <td>r/w</td> <td>r/w</td> <td>r/w</td> <td>r/w</td> <td>r/w</td> <td>r/w</td> <td>r/w</td> </tr> <tr> <td>Function</td> <td colspan="8">Mantissa</td> </tr> <tr> <td>Default Value</td> <td>0</td> <td>1</td> <td>1</td> <td>1</td> <td>1</td> <td>0</td> <td>0</td> <td>0</td> </tr> </tbody> </table>	Format	Linear, two's complement binary								Bit Position	7	6	5	4	3	2	1	0	Access	r	r	r	r	r	r	r	r	Function	Exponent				Mantissa				Default Value	1	1	1	0	1	0	0	0	Bit Position	7	6	5	4	3	2	1	0	Access	r	r/w	r/w	r/w	r/w	r/w	r/w	r/w	Function	Mantissa								Default Value	0	1	1	1	1	0	0	0	YES
Format	Linear, two's complement binary																																																																																			
Bit Position	7	6	5	4	3	2	1	0																																																																												
Access	r	r	r	r	r	r	r	r																																																																												
Function	Exponent				Mantissa																																																																															
Default Value	1	1	1	0	1	0	0	0																																																																												
Bit Position	7	6	5	4	3	2	1	0																																																																												
Access	r	r/w	r/w	r/w	r/w	r/w	r/w	r/w																																																																												
Function	Mantissa																																																																																			
Default Value	0	1	1	1	1	0	0	0																																																																												
55	VIN_OV_FAULT_LIMIT	<p>Sets the voltage level for an input overvoltage fault.</p> <table border="1"> <thead> <tr> <th>Format</th> <th colspan="8">Linear, two's complement binary</th> </tr> </thead> <tbody> <tr> <td>Bit Position</td> <td>7</td> <td>6</td> <td>5</td> <td>4</td> <td>3</td> <td>2</td> <td>1</td> <td>0</td> </tr> <tr> <td>Access</td> <td>r</td> <td>r</td> <td>r</td> <td>r</td> <td>r</td> <td>r</td> <td>r</td> <td>r</td> </tr> <tr> <td>Function</td> <td colspan="4">Exponent</td> <td colspan="4">Mantissa</td> </tr> <tr> <td>Default Value</td> <td>1</td> <td>1</td> <td>1</td> <td>0</td> <td>1</td> <td>0</td> <td>1</td> <td>0</td> </tr> <tr> <td>Bit Position</td> <td>7</td> <td>6</td> <td>5</td> <td>4</td> <td>3</td> <td>2</td> <td>1</td> <td>0</td> </tr> <tr> <td>Access</td> <td>r</td> <td>r/w</td> <td>r/w</td> <td>r/w</td> <td>r/w</td> <td>r/w</td> <td>r/w</td> <td>r/w</td> </tr> <tr> <td>Function</td> <td colspan="8">Mantissa</td> </tr> <tr> <td>Default Value</td> <td>1</td> <td>1</td> <td>0</td> <td>0</td> <td>1</td> <td>0</td> <td>0</td> <td>0</td> </tr> </tbody> </table>	Format	Linear, two's complement binary								Bit Position	7	6	5	4	3	2	1	0	Access	r	r	r	r	r	r	r	r	Function	Exponent				Mantissa				Default Value	1	1	1	0	1	0	1	0	Bit Position	7	6	5	4	3	2	1	0	Access	r	r/w	r/w	r/w	r/w	r/w	r/w	r/w	Function	Mantissa								Default Value	1	1	0	0	1	0	0	0	YES
Format	Linear, two's complement binary																																																																																			
Bit Position	7	6	5	4	3	2	1	0																																																																												
Access	r	r	r	r	r	r	r	r																																																																												
Function	Exponent				Mantissa																																																																															
Default Value	1	1	1	0	1	0	1	0																																																																												
Bit Position	7	6	5	4	3	2	1	0																																																																												
Access	r	r/w	r/w	r/w	r/w	r/w	r/w	r/w																																																																												
Function	Mantissa																																																																																			
Default Value	1	1	0	0	1	0	0	0																																																																												

## JRCS016: Non-Isolated DC-DC Power Modules

18Vdc-85Vdc input 18.5Vdc to 60Vdc output: 400W Max. Output

79	STATUS_WORD	<p>Returns two bytes of information with a summary of the module's fault/warning conditions.</p> <p>This PMBus command does not support to report correct state (Such as OVP, OCP, OTP, Input UVP/OVP, ON/OFF), and no other command can be used to report these failures.</p> <table border="1"> <thead> <tr> <th>Format</th> <th colspan="8">Unsigned Binary</th> </tr> </thead> <tbody> <tr> <td>Bit Position</td> <td>7</td> <td>6</td> <td>5</td> <td>4</td> <td>3</td> <td>2</td> <td>1</td> <td>0</td> </tr> <tr> <td>Access</td> <td>r</td> <td>r</td> <td>r</td> <td>r</td> <td>r</td> <td>r</td> <td>r</td> <td>r</td> </tr> <tr> <td>Flag</td> <td>X</td> <td>X</td> <td>X</td> <td>X</td> <td>X</td> <td>X</td> <td>X</td> <td>X</td> </tr> <tr> <td>Default Value</td> <td>0</td> <td>0</td> <td>0</td> <td>0</td> <td>0</td> <td>0</td> <td>0</td> <td>0</td> </tr> <tr> <td>Bit Position</td> <td>7</td> <td>6</td> <td>5</td> <td>4</td> <td>3</td> <td>2</td> <td>1</td> <td>0</td> </tr> <tr> <td>Access</td> <td>r</td> <td>r</td> <td>r</td> <td>r</td> <td>r</td> <td>r</td> <td>r</td> <td>r</td> </tr> <tr> <td>Flag</td> <td>X</td> <td>X</td> <td>X</td> <td>X</td> <td>X</td> <td>TEMP</td> <td>CML</td> <td>OTHE R</td> </tr> <tr> <td>Default Value</td> <td>0</td> <td>0</td> <td>0</td> <td>0</td> <td>0</td> <td>0</td> <td>0</td> <td>0</td> </tr> </tbody> </table>	Format	Unsigned Binary								Bit Position	7	6	5	4	3	2	1	0	Access	r	r	r	r	r	r	r	r	Flag	X	X	X	X	X	X	X	X	Default Value	0	0	0	0	0	0	0	0	Bit Position	7	6	5	4	3	2	1	0	Access	r	r	r	r	r	r	r	r	Flag	X	X	X	X	X	TEMP	CML	OTHE R	Default Value	0	0	0	0	0	0	0	0
Format	Unsigned Binary																																																																																		
Bit Position	7	6	5	4	3	2	1	0																																																																											
Access	r	r	r	r	r	r	r	r																																																																											
Flag	X	X	X	X	X	X	X	X																																																																											
Default Value	0	0	0	0	0	0	0	0																																																																											
Bit Position	7	6	5	4	3	2	1	0																																																																											
Access	r	r	r	r	r	r	r	r																																																																											
Flag	X	X	X	X	X	TEMP	CML	OTHE R																																																																											
Default Value	0	0	0	0	0	0	0	0																																																																											
7E	STATUS_CML	<p>Returns one byte of information with the status of the module's communication related faults</p> <table border="1"> <thead> <tr> <th>Format</th> <th colspan="8">Unsigned Binary</th> </tr> </thead> <tbody> <tr> <td>Bit Position</td> <td>7</td> <td>6</td> <td>5</td> <td>4</td> <td>3</td> <td>2</td> <td>1</td> <td>0</td> </tr> <tr> <td>Access</td> <td>r</td> <td>r</td> <td>r</td> <td>r</td> <td>r</td> <td>r</td> <td>r</td> <td>r</td> </tr> <tr> <td>Flag</td> <td>Invalid Command</td> <td>Invalid Data</td> <td>PEC Fail</td> <td>X</td> <td>X</td> <td>X</td> <td>Other Comm Fault</td> <td>X</td> </tr> <tr> <td>Default Value</td> <td>0</td> <td>0</td> <td>0</td> <td>0</td> <td>0</td> <td>0</td> <td>0</td> <td>0</td> </tr> </tbody> </table>	Format	Unsigned Binary								Bit Position	7	6	5	4	3	2	1	0	Access	r	r	r	r	r	r	r	r	Flag	Invalid Command	Invalid Data	PEC Fail	X	X	X	Other Comm Fault	X	Default Value	0	0	0	0	0	0	0	0																																				
Format	Unsigned Binary																																																																																		
Bit Position	7	6	5	4	3	2	1	0																																																																											
Access	r	r	r	r	r	r	r	r																																																																											
Flag	Invalid Command	Invalid Data	PEC Fail	X	X	X	Other Comm Fault	X																																																																											
Default Value	0	0	0	0	0	0	0	0																																																																											
88	READ_VIN	<p>Returns the value of the input voltage applied to the module</p> <table border="1"> <thead> <tr> <th>Format</th> <th colspan="8">Linear, two's complement binary</th> </tr> </thead> <tbody> <tr> <td>Bit Position</td> <td>7</td> <td>6</td> <td>5</td> <td>4</td> <td>3</td> <td>2</td> <td>1</td> <td>0</td> </tr> <tr> <td>Access</td> <td>r</td> <td>r</td> <td>r</td> <td>r</td> <td>r</td> <td>r</td> <td>r</td> <td>r</td> </tr> <tr> <td>Function</td> <td colspan="4">Exponent</td> <td colspan="4">Mantissa</td> </tr> <tr> <td>Default Value</td> <td>1</td> <td>1</td> <td>1</td> <td>0</td> <td>1</td> <td>0</td> <td>0</td> <td>0</td> </tr> <tr> <td>Bit Position</td> <td>7</td> <td>6</td> <td>5</td> <td>4</td> <td>3</td> <td>2</td> <td>1</td> <td>0</td> </tr> <tr> <td>Access</td> <td>r</td> <td>r</td> <td>r</td> <td>r</td> <td>r</td> <td>r</td> <td>r</td> <td>r</td> </tr> <tr> <td>Function</td> <td colspan="8">Mantissa</td> </tr> <tr> <td>Default Value</td> <td>0</td> <td>0</td> <td>0</td> <td>0</td> <td>0</td> <td>0</td> <td>0</td> <td>0</td> </tr> </tbody> </table>	Format	Linear, two's complement binary								Bit Position	7	6	5	4	3	2	1	0	Access	r	r	r	r	r	r	r	r	Function	Exponent				Mantissa				Default Value	1	1	1	0	1	0	0	0	Bit Position	7	6	5	4	3	2	1	0	Access	r	r	r	r	r	r	r	r	Function	Mantissa								Default Value	0	0	0	0	0	0	0	0
Format	Linear, two's complement binary																																																																																		
Bit Position	7	6	5	4	3	2	1	0																																																																											
Access	r	r	r	r	r	r	r	r																																																																											
Function	Exponent				Mantissa																																																																														
Default Value	1	1	1	0	1	0	0	0																																																																											
Bit Position	7	6	5	4	3	2	1	0																																																																											
Access	r	r	r	r	r	r	r	r																																																																											
Function	Mantissa																																																																																		
Default Value	0	0	0	0	0	0	0	0																																																																											
8B	READ_VOUT	<p>Returns the value of the output voltage of the module. Exponent is fixed at -8.</p> <table border="1"> <thead> <tr> <th>Format</th> <th colspan="8">Linear, two's complement binary</th> </tr> </thead> <tbody> <tr> <td>Bit Position</td> <td>7</td> <td>6</td> <td>5</td> <td>4</td> <td>3</td> <td>2</td> <td>1</td> <td>0</td> </tr> <tr> <td>Access</td> <td>r</td> <td>r</td> <td>r</td> <td>r</td> <td>r</td> <td>r</td> <td>r</td> <td>r</td> </tr> <tr> <td>Function</td> <td colspan="8">Mantissa</td> </tr> <tr> <td>Default Value</td> <td>0</td> <td>0</td> <td>0</td> <td>0</td> <td>0</td> <td>0</td> <td>0</td> <td>0</td> </tr> <tr> <td>Bit Position</td> <td>7</td> <td>6</td> <td>5</td> <td>4</td> <td>3</td> <td>2</td> <td>1</td> <td>0</td> </tr> <tr> <td>Access</td> <td>r</td> <td>r</td> <td>r</td> <td>r</td> <td>r</td> <td>r</td> <td>r</td> <td>r</td> </tr> <tr> <td>Function</td> <td colspan="8">Mantissa</td> </tr> <tr> <td>Default Value</td> <td>0</td> <td>0</td> <td>0</td> <td>0</td> <td>0</td> <td>0</td> <td>0</td> <td>0</td> </tr> </tbody> </table>	Format	Linear, two's complement binary								Bit Position	7	6	5	4	3	2	1	0	Access	r	r	r	r	r	r	r	r	Function	Mantissa								Default Value	0	0	0	0	0	0	0	0	Bit Position	7	6	5	4	3	2	1	0	Access	r	r	r	r	r	r	r	r	Function	Mantissa								Default Value	0	0	0	0	0	0	0	0
Format	Linear, two's complement binary																																																																																		
Bit Position	7	6	5	4	3	2	1	0																																																																											
Access	r	r	r	r	r	r	r	r																																																																											
Function	Mantissa																																																																																		
Default Value	0	0	0	0	0	0	0	0																																																																											
Bit Position	7	6	5	4	3	2	1	0																																																																											
Access	r	r	r	r	r	r	r	r																																																																											
Function	Mantissa																																																																																		
Default Value	0	0	0	0	0	0	0	0																																																																											

## JRCS016: Non-Isolated DC-DC Power Modules

18Vdc-85Vdc input 18.5Vdc to 60Vdc output: 400W Max. Output

8C	READ_IOUT	<p>Returns the value of the output current of the module</p> <table border="1"> <thead> <tr> <th>Format</th> <th colspan="8">Linear, two's complement binary</th> </tr> </thead> <tbody> <tr> <td>Bit Position</td> <td>7</td> <td>6</td> <td>5</td> <td>4</td> <td>3</td> <td>2</td> <td>1</td> <td>0</td> </tr> <tr> <td>Access</td> <td>r</td> <td>r</td> <td>r</td> <td>r</td> <td>r</td> <td>r</td> <td>r</td> <td>r</td> </tr> <tr> <th>Function</th> <th colspan="4">Exponent</th> <th colspan="4">Mantissa</th> </tr> <tr> <td>Default Value</td> <td>1</td> <td>1</td> <td>1</td> <td>0</td> <td>0</td> <td>0</td> <td>0</td> <td>0</td> </tr> <tr> <td>Bit Position</td> <td>7</td> <td>6</td> <td>5</td> <td>4</td> <td>3</td> <td>2</td> <td>1</td> <td>0</td> </tr> <tr> <td>Access</td> <td>r</td> <td>r</td> <td>r</td> <td>r</td> <td>r</td> <td>r</td> <td>r</td> <td>r</td> </tr> <tr> <th>Function</th> <th colspan="8">Mantissa</th> </tr> <tr> <td>Default Value</td> <td>0</td> <td>0</td> <td>0</td> <td>0</td> <td>0</td> <td>0</td> <td>0</td> <td>0</td> </tr> </tbody> </table>	Format	Linear, two's complement binary								Bit Position	7	6	5	4	3	2	1	0	Access	r	r	r	r	r	r	r	r	Function	Exponent				Mantissa				Default Value	1	1	1	0	0	0	0	0	Bit Position	7	6	5	4	3	2	1	0	Access	r	r	r	r	r	r	r	r	Function	Mantissa								Default Value	0	0	0	0	0	0	0	0	
Format	Linear, two's complement binary																																																																																			
Bit Position	7	6	5	4	3	2	1	0																																																																												
Access	r	r	r	r	r	r	r	r																																																																												
Function	Exponent				Mantissa																																																																															
Default Value	1	1	1	0	0	0	0	0																																																																												
Bit Position	7	6	5	4	3	2	1	0																																																																												
Access	r	r	r	r	r	r	r	r																																																																												
Function	Mantissa																																																																																			
Default Value	0	0	0	0	0	0	0	0																																																																												
8D	READ_TEMP_1	<p>Returns the value of the temperature sensor 1 of the module</p> <table border="1"> <thead> <tr> <th>Format</th> <th colspan="8">Linear, two's complement binary</th> </tr> </thead> <tbody> <tr> <td>Bit Position</td> <td>7</td> <td>6</td> <td>5</td> <td>4</td> <td>3</td> <td>2</td> <td>1</td> <td>0</td> </tr> <tr> <td>Access</td> <td>r</td> <td>r</td> <td>r</td> <td>r</td> <td>r</td> <td>r</td> <td>r</td> <td>r</td> </tr> <tr> <th>Function</th> <th colspan="4">Exponent</th> <th colspan="4">Mantissa</th> </tr> <tr> <td>Default Value</td> <td>1</td> <td>1</td> <td>1</td> <td>1</td> <td>0</td> <td>0</td> <td>0</td> <td>0</td> </tr> <tr> <td>Bit Position</td> <td>7</td> <td>6</td> <td>5</td> <td>4</td> <td>3</td> <td>2</td> <td>1</td> <td>0</td> </tr> <tr> <td>Access</td> <td>r</td> <td>r</td> <td>r</td> <td>r</td> <td>r</td> <td>r</td> <td>r</td> <td>r</td> </tr> <tr> <th>Function</th> <th colspan="8">Mantissa</th> </tr> <tr> <td>Default Value</td> <td>0</td> <td>0</td> <td>0</td> <td>0</td> <td>0</td> <td>0</td> <td>0</td> <td>0</td> </tr> </tbody> </table>	Format	Linear, two's complement binary								Bit Position	7	6	5	4	3	2	1	0	Access	r	r	r	r	r	r	r	r	Function	Exponent				Mantissa				Default Value	1	1	1	1	0	0	0	0	Bit Position	7	6	5	4	3	2	1	0	Access	r	r	r	r	r	r	r	r	Function	Mantissa								Default Value	0	0	0	0	0	0	0	0	
Format	Linear, two's complement binary																																																																																			
Bit Position	7	6	5	4	3	2	1	0																																																																												
Access	r	r	r	r	r	r	r	r																																																																												
Function	Exponent				Mantissa																																																																															
Default Value	1	1	1	1	0	0	0	0																																																																												
Bit Position	7	6	5	4	3	2	1	0																																																																												
Access	r	r	r	r	r	r	r	r																																																																												
Function	Mantissa																																																																																			
Default Value	0	0	0	0	0	0	0	0																																																																												
8E	READ_TEMP_2	<p>Returns the value of the temperature sensor 2 of the module</p> <table border="1"> <thead> <tr> <th>Format</th> <th colspan="8">Linear, two's complement binary</th> </tr> </thead> <tbody> <tr> <td>Bit Position</td> <td>7</td> <td>6</td> <td>5</td> <td>4</td> <td>3</td> <td>2</td> <td>1</td> <td>0</td> </tr> <tr> <td>Access</td> <td>r</td> <td>r</td> <td>r</td> <td>r</td> <td>r</td> <td>r</td> <td>r</td> <td>r</td> </tr> <tr> <th>Function</th> <th colspan="4">Exponent</th> <th colspan="4">Mantissa</th> </tr> <tr> <td>Default Value</td> <td>1</td> <td>1</td> <td>1</td> <td>1</td> <td>0</td> <td>0</td> <td>0</td> <td>0</td> </tr> <tr> <td>Bit Position</td> <td>7</td> <td>6</td> <td>5</td> <td>4</td> <td>3</td> <td>2</td> <td>1</td> <td>0</td> </tr> <tr> <td>Access</td> <td>r</td> <td>r</td> <td>r</td> <td>r</td> <td>r</td> <td>r</td> <td>r</td> <td>r</td> </tr> <tr> <th>Function</th> <th colspan="8">Mantissa</th> </tr> <tr> <td>Default Value</td> <td>0</td> <td>0</td> <td>0</td> <td>0</td> <td>0</td> <td>0</td> <td>0</td> <td>0</td> </tr> </tbody> </table>	Format	Linear, two's complement binary								Bit Position	7	6	5	4	3	2	1	0	Access	r	r	r	r	r	r	r	r	Function	Exponent				Mantissa				Default Value	1	1	1	1	0	0	0	0	Bit Position	7	6	5	4	3	2	1	0	Access	r	r	r	r	r	r	r	r	Function	Mantissa								Default Value	0	0	0	0	0	0	0	0	
Format	Linear, two's complement binary																																																																																			
Bit Position	7	6	5	4	3	2	1	0																																																																												
Access	r	r	r	r	r	r	r	r																																																																												
Function	Exponent				Mantissa																																																																															
Default Value	1	1	1	1	0	0	0	0																																																																												
Bit Position	7	6	5	4	3	2	1	0																																																																												
Access	r	r	r	r	r	r	r	r																																																																												
Function	Mantissa																																																																																			
Default Value	0	0	0	0	0	0	0	0																																																																												
98	PMBUS_REVISION	<p>Returns one byte indicating the module is compliant to PMBus Spec. 1.1 (read only)</p> <table border="1"> <thead> <tr> <th>Format</th> <th colspan="8">Unsigned Binary</th> </tr> </thead> <tbody> <tr> <td>Bit Position</td> <td>7</td> <td>6</td> <td>5</td> <td>4</td> <td>3</td> <td>2</td> <td>1</td> <td>0</td> </tr> <tr> <td>Access</td> <td>r</td> <td>r</td> <td>r</td> <td>r</td> <td>r</td> <td>r</td> <td>r</td> <td>r</td> </tr> <tr> <td>Default Value</td> <td>0</td> <td>0</td> <td>0</td> <td>1</td> <td>0</td> <td>0</td> <td>0</td> <td>1</td> </tr> </tbody> </table>	Format	Unsigned Binary								Bit Position	7	6	5	4	3	2	1	0	Access	r	r	r	r	r	r	r	r	Default Value	0	0	0	1	0	0	0	1																																														
Format	Unsigned Binary																																																																																			
Bit Position	7	6	5	4	3	2	1	0																																																																												
Access	r	r	r	r	r	r	r	r																																																																												
Default Value	0	0	0	1	0	0	0	1																																																																												
D1	VOUT_CAL_GAIN	<p>Applies a gain correction to the READ_VOUT command results to calibrate out gain errors in module measurements of the output voltage</p> <table border="1"> <thead> <tr> <th>Format</th> <th colspan="8">Linear, two's complement binary</th> </tr> </thead> <tbody> <tr> <td>Bit Position</td> <td>7</td> <td>6</td> <td>5</td> <td>4</td> <td>3</td> <td>2</td> <td>1</td> <td>0</td> </tr> <tr> <td>Access</td> <td>r/w</td> <td>r/w</td> <td>r/w</td> <td>r/w</td> <td>r/w</td> <td>r/w</td> <td>r/w</td> <td>r/w</td> </tr> <tr> <th>Function</th> <th colspan="8">Mantissa</th> </tr> <tr> <td>Default Value</td> <td colspan="8">Variable based on factory calibration</td> </tr> <tr> <td>Bit Position</td> <td>7</td> <td>6</td> <td>5</td> <td>4</td> <td>3</td> <td>2</td> <td>1</td> <td>0</td> </tr> <tr> <td>Access</td> <td>r/w</td> <td>r/w</td> <td>r/w</td> <td>r/w</td> <td>r/w</td> <td>r/w</td> <td>r/w</td> <td>r/w</td> </tr> <tr> <th>Function</th> <th colspan="8">Mantissa</th> </tr> <tr> <td>Default Value</td> <td colspan="8">Variable based on factory calibration</td> </tr> </tbody> </table>	Format	Linear, two's complement binary								Bit Position	7	6	5	4	3	2	1	0	Access	r/w	r/w	r/w	r/w	r/w	r/w	r/w	r/w	Function	Mantissa								Default Value	Variable based on factory calibration								Bit Position	7	6	5	4	3	2	1	0	Access	r/w	r/w	r/w	r/w	r/w	r/w	r/w	r/w	Function	Mantissa								Default Value	Variable based on factory calibration								YES
Format	Linear, two's complement binary																																																																																			
Bit Position	7	6	5	4	3	2	1	0																																																																												
Access	r/w	r/w	r/w	r/w	r/w	r/w	r/w	r/w																																																																												
Function	Mantissa																																																																																			
Default Value	Variable based on factory calibration																																																																																			
Bit Position	7	6	5	4	3	2	1	0																																																																												
Access	r/w	r/w	r/w	r/w	r/w	r/w	r/w	r/w																																																																												
Function	Mantissa																																																																																			
Default Value	Variable based on factory calibration																																																																																			



## JRCS016: Non-Isolated DC-DC Power Modules

18Vdc-85Vdc input 18.5Vdc to 60Vdc output: 400W Max. Output

D2	VOUT_CAL_OFFSET	<p>Applies an offset to the READ_VOUT command results to calibrate out offset errors in module measurements of the output voltage. Exponent is fixed at -8.</p> <table border="1"> <thead> <tr> <th>Format</th> <th colspan="8">Linear, two's complement binary</th> </tr> </thead> <tbody> <tr> <td>Bit Position</td> <td>7</td><td>6</td><td>5</td><td>4</td><td>3</td><td>2</td><td>1</td><td>0</td> </tr> <tr> <td>Access</td> <td>r/w</td><td>r/w</td><td>r/w</td><td>r/w</td><td>r/w</td><td>r/w</td><td>r/w</td><td>r/w</td> </tr> <tr> <td>Function</td> <td colspan="8">Mantissa</td> </tr> <tr> <td>Default Value</td> <td colspan="8">Variable based on factory calibration</td> </tr> <tr> <td>Bit Position</td> <td>7</td><td>6</td><td>5</td><td>4</td><td>3</td><td>2</td><td>1</td><td>0</td> </tr> <tr> <td>Access</td> <td>r/w</td><td>r/w</td><td>r/w</td><td>r/w</td><td>r/w</td><td>r/w</td><td>r/w</td><td>r/w</td> </tr> <tr> <td>Function</td> <td colspan="8">Mantissa</td> </tr> <tr> <td>Default Value</td> <td colspan="8">Variable based on factory calibration</td> </tr> </tbody> </table>	Format	Linear, two's complement binary								Bit Position	7	6	5	4	3	2	1	0	Access	r/w	r/w	r/w	r/w	r/w	r/w	r/w	r/w	Function	Mantissa								Default Value	Variable based on factory calibration								Bit Position	7	6	5	4	3	2	1	0	Access	r/w	r/w	r/w	r/w	r/w	r/w	r/w	r/w	Function	Mantissa								Default Value	Variable based on factory calibration								YES
Format	Linear, two's complement binary																																																																																			
Bit Position	7	6	5	4	3	2	1	0																																																																												
Access	r/w	r/w	r/w	r/w	r/w	r/w	r/w	r/w																																																																												
Function	Mantissa																																																																																			
Default Value	Variable based on factory calibration																																																																																			
Bit Position	7	6	5	4	3	2	1	0																																																																												
Access	r/w	r/w	r/w	r/w	r/w	r/w	r/w	r/w																																																																												
Function	Mantissa																																																																																			
Default Value	Variable based on factory calibration																																																																																			
D3	VIN_CAL_GAIN	<p>Returns the value of the gain correction term used to correct the measured input voltage.</p> <table border="1"> <thead> <tr> <th>Format</th> <th colspan="8">Linear, two's complement binary</th> </tr> </thead> <tbody> <tr> <td>Bit Position</td> <td>7</td><td>6</td><td>5</td><td>4</td><td>3</td><td>2</td><td>1</td><td>0</td> </tr> <tr> <td>Access</td> <td>r/w</td><td>r/w</td><td>r/w</td><td>r/w</td><td>r/w</td><td>r/w</td><td>r/w</td><td>r/w</td> </tr> <tr> <td>Function</td> <td colspan="8">Mantissa</td> </tr> <tr> <td>Default Value</td> <td colspan="8">Variable based on factory calibration</td> </tr> <tr> <td>Bit Position</td> <td>7</td><td>6</td><td>5</td><td>4</td><td>3</td><td>2</td><td>1</td><td>0</td> </tr> <tr> <td>Access</td> <td>r/w</td><td>r/w</td><td>r/w</td><td>r/w</td><td>r/w</td><td>r/w</td><td>r/w</td><td>r/w</td> </tr> <tr> <td>Function</td> <td colspan="8">Mantissa</td> </tr> <tr> <td>Default Value</td> <td colspan="8">Variable based on factory calibration</td> </tr> </tbody> </table>	Format	Linear, two's complement binary								Bit Position	7	6	5	4	3	2	1	0	Access	r/w	r/w	r/w	r/w	r/w	r/w	r/w	r/w	Function	Mantissa								Default Value	Variable based on factory calibration								Bit Position	7	6	5	4	3	2	1	0	Access	r/w	r/w	r/w	r/w	r/w	r/w	r/w	r/w	Function	Mantissa								Default Value	Variable based on factory calibration								YES
Format	Linear, two's complement binary																																																																																			
Bit Position	7	6	5	4	3	2	1	0																																																																												
Access	r/w	r/w	r/w	r/w	r/w	r/w	r/w	r/w																																																																												
Function	Mantissa																																																																																			
Default Value	Variable based on factory calibration																																																																																			
Bit Position	7	6	5	4	3	2	1	0																																																																												
Access	r/w	r/w	r/w	r/w	r/w	r/w	r/w	r/w																																																																												
Function	Mantissa																																																																																			
Default Value	Variable based on factory calibration																																																																																			
D4	VIN_CAL_OFFSET	<p>Returns the value of the offset correction term used to correct the measured input voltage.</p> <table border="1"> <thead> <tr> <th>Format</th> <th colspan="8">Linear, two's complement binary</th> </tr> </thead> <tbody> <tr> <td>Bit Position</td> <td>7</td><td>6</td><td>5</td><td>4</td><td>3</td><td>2</td><td>1</td><td>0</td> </tr> <tr> <td>Access</td> <td>r</td><td>r</td><td>r</td><td>r</td><td>r</td><td>r/w</td><td>r/w</td><td>r/w</td> </tr> <tr> <td>Function</td> <td colspan="4">Exponent</td> <td colspan="4">Mantissa</td> </tr> <tr> <td>Default Value</td> <td>1</td><td>1</td><td>1</td><td>0</td><td>1</td><td colspan="3">V</td> </tr> <tr> <td>Bit Position</td> <td>7</td><td>6</td><td>5</td><td>4</td><td>3</td><td>2</td><td>1</td><td>0</td> </tr> <tr> <td>Access</td> <td>r/w</td><td>r/w</td><td>r/w</td><td>r/w</td><td>r/w</td><td>r/w</td><td>r/w</td><td>r/w</td> </tr> <tr> <td>Function</td> <td colspan="8">Mantissa</td> </tr> <tr> <td>Default Value</td> <td colspan="8">V: Variable based on factory calibration</td> </tr> </tbody> </table>	Format	Linear, two's complement binary								Bit Position	7	6	5	4	3	2	1	0	Access	r	r	r	r	r	r/w	r/w	r/w	Function	Exponent				Mantissa				Default Value	1	1	1	0	1	V			Bit Position	7	6	5	4	3	2	1	0	Access	r/w	r/w	r/w	r/w	r/w	r/w	r/w	r/w	Function	Mantissa								Default Value	V: Variable based on factory calibration								YES
Format	Linear, two's complement binary																																																																																			
Bit Position	7	6	5	4	3	2	1	0																																																																												
Access	r	r	r	r	r	r/w	r/w	r/w																																																																												
Function	Exponent				Mantissa																																																																															
Default Value	1	1	1	0	1	V																																																																														
Bit Position	7	6	5	4	3	2	1	0																																																																												
Access	r/w	r/w	r/w	r/w	r/w	r/w	r/w	r/w																																																																												
Function	Mantissa																																																																																			
Default Value	V: Variable based on factory calibration																																																																																			
D6	IOUT_CAL_GAIN	<p>Returns the value of the gain correction term used to correct the measured output current</p> <table border="1"> <thead> <tr> <th>Format</th> <th colspan="8">Linear, two's complement binary</th> </tr> </thead> <tbody> <tr> <td>Bit Position</td> <td>7</td><td>6</td><td>5</td><td>4</td><td>3</td><td>2</td><td>1</td><td>0</td> </tr> <tr> <td>Access</td> <td>r/w</td><td>r/w</td><td>r/w</td><td>r/w</td><td>r/w</td><td>r/w</td><td>r/w</td><td>r/w</td> </tr> <tr> <td>Function</td> <td colspan="8">Mantissa</td> </tr> <tr> <td>Default Value</td> <td colspan="8">Variable based on factory calibration</td> </tr> <tr> <td>Bit Position</td> <td>7</td><td>6</td><td>5</td><td>4</td><td>3</td><td>2</td><td>1</td><td>0</td> </tr> <tr> <td>Access</td> <td>r/w</td><td>r/w</td><td>r/w</td><td>r/w</td><td>r/w</td><td>r/w</td><td>r/w</td><td>r/w</td> </tr> <tr> <td>Function</td> <td colspan="8">Mantissa</td> </tr> <tr> <td>Default Value</td> <td colspan="8">Variable based on factory calibration</td> </tr> </tbody> </table>	Format	Linear, two's complement binary								Bit Position	7	6	5	4	3	2	1	0	Access	r/w	r/w	r/w	r/w	r/w	r/w	r/w	r/w	Function	Mantissa								Default Value	Variable based on factory calibration								Bit Position	7	6	5	4	3	2	1	0	Access	r/w	r/w	r/w	r/w	r/w	r/w	r/w	r/w	Function	Mantissa								Default Value	Variable based on factory calibration								YES
Format	Linear, two's complement binary																																																																																			
Bit Position	7	6	5	4	3	2	1	0																																																																												
Access	r/w	r/w	r/w	r/w	r/w	r/w	r/w	r/w																																																																												
Function	Mantissa																																																																																			
Default Value	Variable based on factory calibration																																																																																			
Bit Position	7	6	5	4	3	2	1	0																																																																												
Access	r/w	r/w	r/w	r/w	r/w	r/w	r/w	r/w																																																																												
Function	Mantissa																																																																																			
Default Value	Variable based on factory calibration																																																																																			
D7	IOUT_CAL_OFFSET	<p>Returns the value of the offset correction term used to correct the measured output current</p> <table border="1"> <thead> <tr> <th>Format</th> <th colspan="8">Linear, two's complement binary</th> </tr> </thead> <tbody> <tr> <td>Bit Position</td> <td>7</td><td>6</td><td>5</td><td>4</td><td>3</td><td>2</td><td>1</td><td>0</td> </tr> <tr> <td>Access</td> <td>r</td><td>r</td><td>r</td><td>r</td><td>r</td><td>r/w</td><td>r/w</td><td>r/w</td> </tr> <tr> <td>Function</td> <td colspan="4">Exponent</td> <td colspan="4">Mantissa</td> </tr> <tr> <td>Default Value</td> <td>1</td><td>1</td><td>1</td><td>0</td><td>0</td><td colspan="3">V</td> </tr> <tr> <td>Bit Position</td> <td>7</td><td>6</td><td>5</td><td>4</td><td>3</td><td>2</td><td>1</td><td>0</td> </tr> <tr> <td>Access</td> <td>r/w</td><td>r/w</td><td>r/w</td><td>r/w</td><td>r/w</td><td>r/w</td><td>r/w</td><td>r/w</td> </tr> <tr> <td>Function</td> <td colspan="8">Mantissa</td> </tr> <tr> <td>Default Value</td> <td colspan="8">V: Variable based on factory calibration</td> </tr> </tbody> </table>	Format	Linear, two's complement binary								Bit Position	7	6	5	4	3	2	1	0	Access	r	r	r	r	r	r/w	r/w	r/w	Function	Exponent				Mantissa				Default Value	1	1	1	0	0	V			Bit Position	7	6	5	4	3	2	1	0	Access	r/w	r/w	r/w	r/w	r/w	r/w	r/w	r/w	Function	Mantissa								Default Value	V: Variable based on factory calibration								YES
Format	Linear, two's complement binary																																																																																			
Bit Position	7	6	5	4	3	2	1	0																																																																												
Access	r	r	r	r	r	r/w	r/w	r/w																																																																												
Function	Exponent				Mantissa																																																																															
Default Value	1	1	1	0	0	V																																																																														
Bit Position	7	6	5	4	3	2	1	0																																																																												
Access	r/w	r/w	r/w	r/w	r/w	r/w	r/w	r/w																																																																												
Function	Mantissa																																																																																			
Default Value	V: Variable based on factory calibration																																																																																			
DB	FW_REV	Returns the firmware version in format of "0xMj.Mn.Bh.BI"																																																																																		

## JRCS016: Non-Isolated DC-DC Power Modules

18Vdc-85Vdc input 18.5Vdc to 60Vdc output: 400W Max. Output

### Thermal Considerations

Power modules operate in a variety of thermal environments; however, sufficient cooling should always be provided to help ensure reliable operation.

Considerations include ambient temperature, airflow, module power dissipation, and the need for increased reliability. A reduction in the operating temperature of the module will result in an increase in reliability. The thermal data presented here is based on physical measurements taken in a wind tunnel. The test set-up is shown in Figure 28. The preferred airflow direction for the module is in Figure 29.

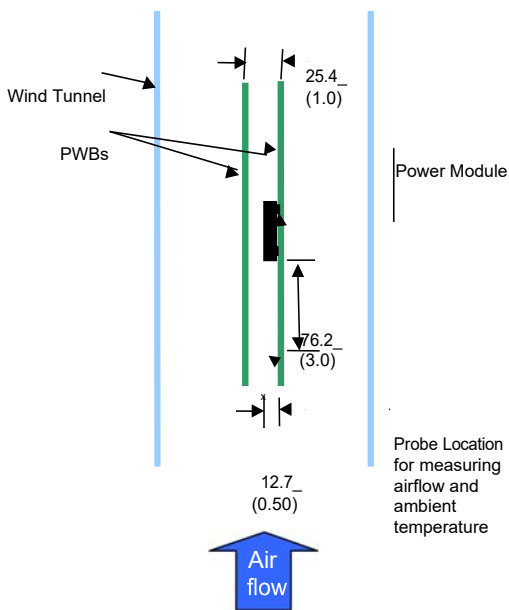

Figure 28. Thermal Test Setup.

The thermal reference points,  $T_{ref1}$  and  $T_{ref2}$  used in the specifications are also shown in Figure 29. For reliable operation the temperatures at these points should not exceed 98°C. The output power of the module should not exceed the rated power of the module ( $V_{o,set} \times I_{o,max}$ ).

Please refer to the Application Note “Thermal Characterization Process for Open-Frame Board-Mounted Power Modules” for a detailed discussion of thermal aspects including maximum device temperatures.

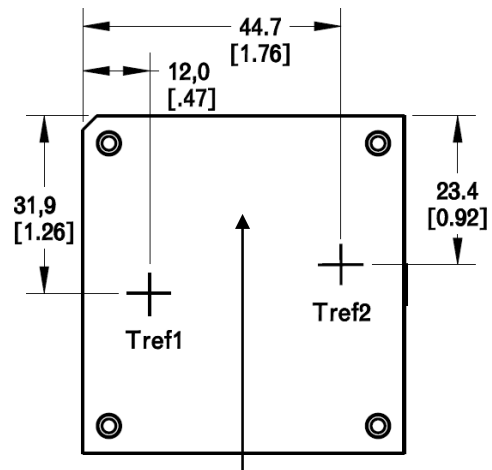

Figure 29. Location of hot-spots of the module ( $T_{ref1}$  and  $T_{ref2}$ ).

## JRCS016: Non-Isolated DC-DC Power Modules

18Vdc-85Vdc input 18.5Vdc to 60Vdc output: 400W Max. Output

### Layout Considerations

The JRCS016 power module series are constructed using a single PWB with integral base plate; as such, component clearance between the bottom of the power module and the mounting (Host) board is limited. Avoid placing copper areas on the outer layer directly underneath the power module.

### Post Solder Cleaning and Drying Considerations

Post solder cleaning is usually the final circuit-board assembly process prior to electrical board testing. The result of inadequate cleaning and drying can affect both the reliability of a power module and the testability of the finished circuit-board assembly. For guidance on appropriate soldering, cleaning and drying procedures, refer to *GE Board Mounted Power Modules: Soldering and Cleaning* Application Note.

### Through-Hole Lead-Free Soldering Information

The RoHS-compliant through-hole products use the SAC (Sn/Ag/Cu) Pb-free solder and RoHS-compliant components. They are designed to be processed through single or dual wave soldering machines. The pins have an RoHS-compliant finish that is compatible with both Pb and Pb-free wave soldering processes. A maximum preheat rate of 3°C/s is suggested. The wave preheat process should be such that the temperature of the power module board is kept below 210°C. For Pb solder, the recommended pot temperature is 260°C, while the Pb-free solder pot is 270°C max. The JRCS016 cannot be processed with paste-through-hole Pb or Pb-free reflow process. If additional information is needed, please consult with your GE representative for more details.

## JRCS016: Non-Isolated DC-DC Power Modules

18Vdc-85Vdc input 18.5Vdc to 60Vdc output: 400W Max. Output

### Mechanical Outline

Dimensions are in millimeters and [inches].

Tolerances: x.x mm ± 0.5 mm [x.xx in. ± 0.02 in.] (unless otherwise indicated)

x.xx mm ± 0.25 mm [x.xxx in ± 0.010 in.]

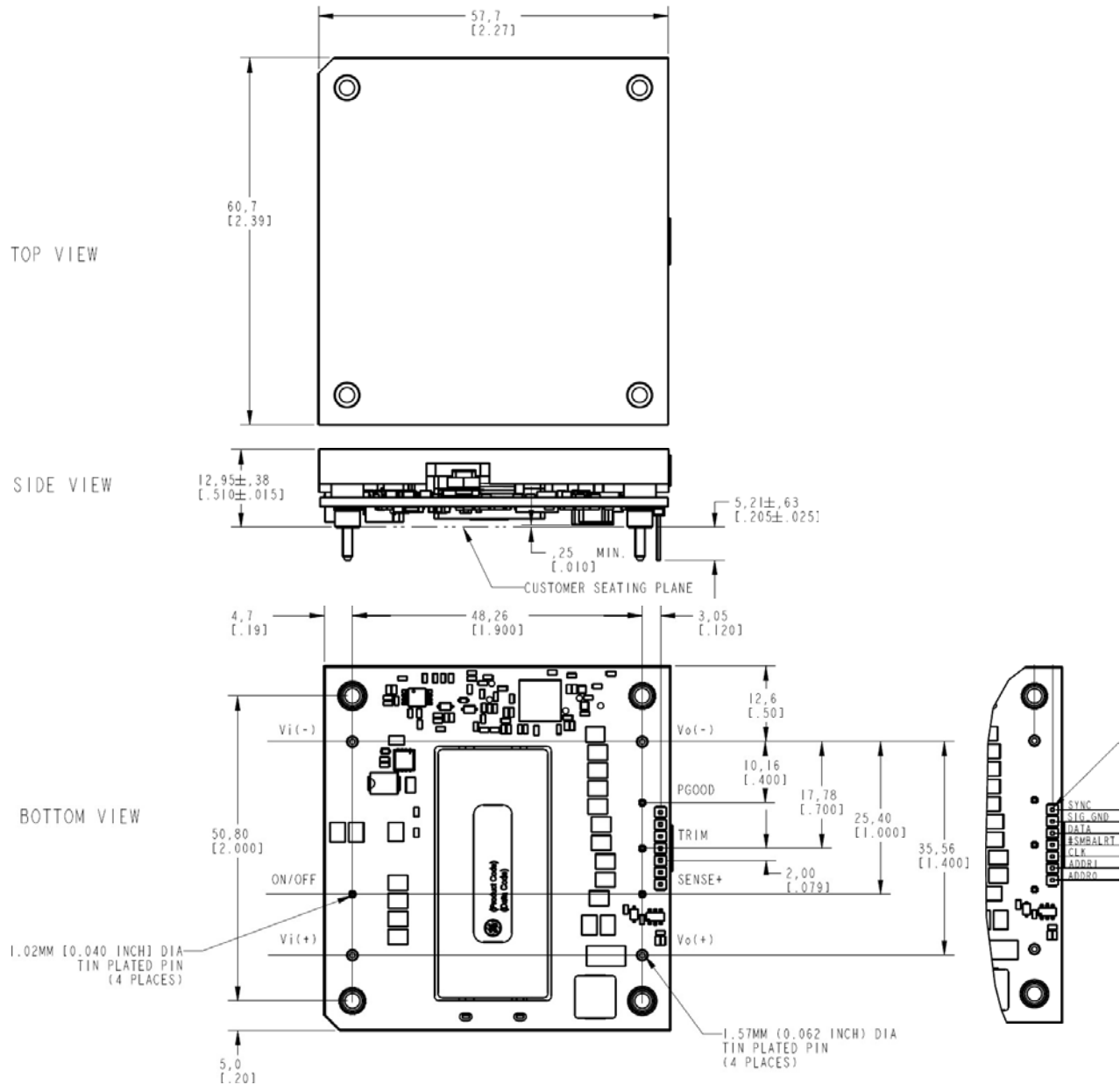

PIN	FUNCTION	PIN	FUNCTION	PIN	FUNCTION
1	VI(+)	6	TRIM	11	DATA
2	ON/OFF	7	+SEN	12	#SMBALRT
3	VI(-)	8	VO(+)	13	CLK
4	Vo(-)	9	SYNC	14	ADDR1
5	PGOOD	10	SIG_GND	15	ADDR0

Note: Pins 9, 10, 11, 12, 13, 14 and 15 can be NC when modules do not have the PMBus function.

## JRCS016: Non-Isolated DC-DC Power Modules

18Vdc-85Vdc input 18.5Vdc to 60Vdc output: 400W Max. Output

### Recommended Pad Layout for Through Hole Module

Dimensions are in millimeters and [inches].

Tolerances:  $x.x \text{ mm} \pm 0.5 \text{ mm}$  [ $x.xx \text{ in.} \pm 0.02 \text{ in.}$ ] (unless otherwise indicated)

$x.xx \text{ mm} \pm 0.25 \text{ mm}$  [ $x.xxx \text{ in} \pm 0.010 \text{ in.}$ ]

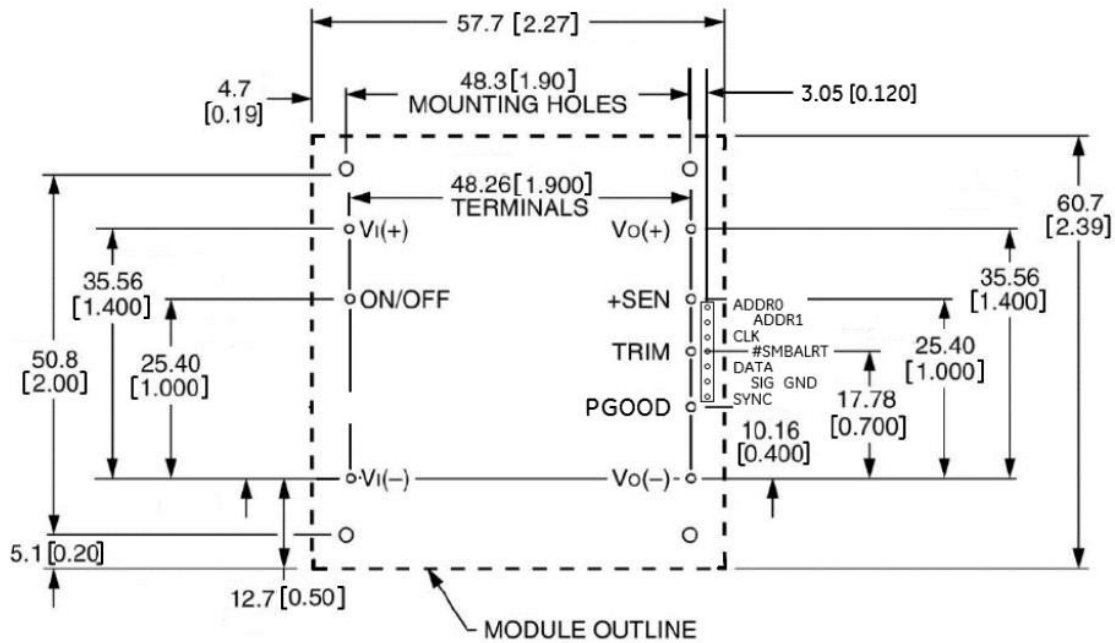

## JRCS016: Non-Isolated DC-DC Power Modules

18Vdc-85Vdc input 18.5Vdc to 60Vdc output: 400W Max. Output

### Product Matrix

Device Code	Input Voltage Range	Output Voltage	Output Current	On/Off Logic	Comcode
JRCS016A0S4-HZ	18 - 85Vdc	18.5 - 60Vdc	16.7A to 6.7A	Positive	1600130338A
JRCS016A0S64-HZ	18 - 85Vdc	18.5 - 60Vdc	16.7A to 6.7A	Positive	150038175
JRCS016A0S4-PHZ	18 - 85Vdc	18.5 - 60Vdc	16.7A to 6.7A	Positive	1600311837A
JRCS016A0S64-PHZ	18 - 85Vdc	18.5 - 60Vdc	16.7A to 6.7A	Positive	1600321885A

### Device Description

	Characteristic	Character and Position	Definition
Ratings	Form Factor	J	J = Half Brick
	Family Designator	RC	
	Input Voltage	S	S = Special Range, 18V-85V
	Output Power	016A0	016A0 = 016.0 Amps Maximum Output Current
	Output Voltage	S	S = Special Voltage, 18.5-60V
Options	Pin Length	6 8	Omit = Default Pin Length shown in Mechanical Outline Figures 6 = Pin Length: 3.68 mm ± 0.25mm , (0.145 in. ± 0.010 in.) 8 = Pin Length: 2.79 mm ± 0.25mm , (0.110 in. ± 0.010 in.)
	Action following Protective Shutdown	4	Omit = Latching Mode 4 = Auto-restart following shutdown (Overcurrent/Overvoltage)
	On/Off Logic	1	Omit = Positive Logic 1 = Negative Logic
	Customer Specific	XY	XY = Customer Specific Modified Code, Omit for Standard Code
	Optional Features	P	Omit = Standard open Frame Module P = Paralleling with current sharing between outputs
		H	H = Heat plate, for use with heat sinks or cold-walls
	RoHS	Z	Omit = RoHS 5/6, Lead Based Solder Used Z = RoHS 6/6 Compliant, Lead free

-Z refers to RoHS compliant parts

ABB Power Electronics Inc.'s digital non-isolated DC-DC products may be covered by one or more of the following patents licensed from Bel Power Solutions, Inc.: US20040246754, US2004090219A1, US2004093533A1, US2004123164A1, US2004123167A1, US2004178780A1, US2004179382A1, US20050200344, US20050223252, US2005289373A1, US20060061214, US2006015616A1, US20060174145, US20070226526, US20070234095, US20070240000, US20080052551, US20080072080, US20080186006, US6741099, US6788036, US6936999, US6949916, US7000125, US7049798, US7068021, US7080265, US7249267, US7266709, US7315156, US7372682, US7373527, US7394445, US7456617, US7459892, US7493504, US7526660.

Outside the US Bel Power Solutions, Inc. licensed technology is protected by patents: AU3287379A, AU3287437A, AU3290643A, AU3291357A, CN10371856C, CN10452610C, CN10458656C, CN10459360C, CN10465848C, CN11069332A, CN11124619A, CN11346682A, CN1685299A, CN1685459A, CN1685582A, CN1685583A, CN1698023A, CN1802619A, EP1561156A1, EP1561268A2, EP1576710A1, EP1576711A1, EP1604254A4, EP1604264A4, EP1714369A2, EP1745536A4, EP1769382A4, EP1899789A2, EP1984801A2, W004044718A1, W004045042A3, W004045042C1, W004062061 A1, W004062062A1, W004070780A3, W004084390A3, W004084391A3, W005079227A3, W005081771A3, W006019569A3, W02007001584A3, W02007094935A3

## Contact Us

For more information, call us at

USA/Canada:

+1 888 546 3243, or +1 972 244 9288

Asia-Pacific:

+86-21-53899666

Europe, Middle-East and Africa:

+49.89.878067-280

[Go.ABB/Industrial](http://Go.ABB/Industrial)

ABB reserves the right to make changes to the product(s) or information contained herein without notice, and no liability is assumed as a result of their use or application. No rights under any patent accompany the sale of any such product(s) or information.

