

LM100-23B SERIES

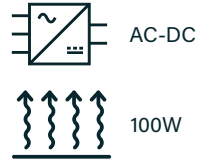

DIMENSIONS:

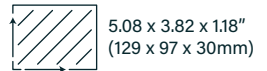

EN55032 LEVEL B

85 to 305 VAC

-30 to 70°C OPERATION

Part numbers

LM	100	-	23B	12	-	C
Series	Power (W)		Input voltage	Output voltage		Options
			85-305VAC	05 = 05VDC 12 = 12VDC 15 = 15VDC 24 = 24VDC 36 = 36VDC 48 = 48VDC 55 = 55VDC		-C = terminal cover -Q = conformal coating

Key specifications

Input range	Safety certification	Features	Efficiency	Environmental performance
85-305VAC	IEC/UL/EN 62368-1, CE, CCC EN 60335-1	Output Voltage Adjust	85.5-90.5%	Operational: -30 to 70°C

LM100-23B SERIES

Mechanical

THIRD ANGLE PROJECTION 

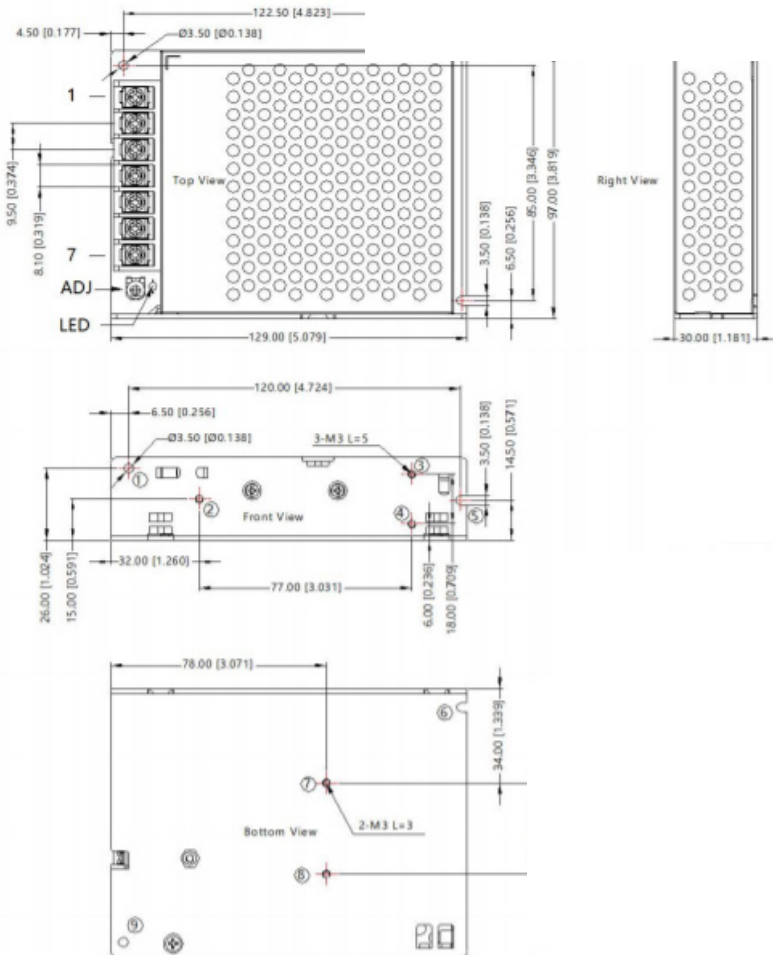

Connector	Pin/Function
1	AC(L)
2	AC(N)
3	GND
4	-VO
5	-VO
6	+VO
7	+VO

Notes

1. All dimensions shown in mm [Inch]
2. General tolerance ± 1.00 [± 0.039]
3. Wire range: 22-12AWG
4. Connector lightning torque: M3.5, 0.8N-m
5. Pos 2&3 L=5mm, pos 6&7 L=3mm

Weight

5V	12V - 48V
325g	305g

LM100-23B SERIES

Models & Ratings

Model Number ⁽¹⁾	Output power	Output voltage	Output voltage adjustable range	Output current	Efficiency ⁽²⁾	Capacitive load
LM100-23B05	90W	5V	4.5-5.5V	18A	85.5%	10000uF
LM100-23B12	102W	12V	10.2-13.8V	8.5A	87%	6800uF
LM100-23B15	105W	15V	13.5-18V	7A	87%	3500uF
LM100-23B24	108W	24V	21.6-28.8V	4.5A	89.5%	2200uF
LM100-23B36	100.8W	36V	32.4-39.6V	2.8A	89.5%	1000uF
LM100-23B48	110.4W	48V	43.2-52.8V	2.3A	90.5%	470uF

1. Add -C for terminal cover and Q for conformal coating
 2. Typical at 100% load 230VAC

Input

Parameter	Min	Typical	Max	Unit	Notes/Conditions
Input voltage	85		305	VAC	See page 5 for derating curve
Input frequency	47		63	Hz	
Input current (rms)		1.5/3		A	230VAC/115VAC
Inrush current		35/65		A	115/230VAC cold start at 25°C
No load input power	0.3		0.5	W	0.3W for 5-24V, 0.5W for 36-48V
Leakage current		<750		uA	277VAC

Output

Parameter	Min	Typical	Max	Unit	Notes/Conditions
Output voltage	5		48	VDC	See Models & Ratings table
Set point accuracy	±1		±2	%	5V ±2%, all others ±1%
Line regulation			±0.5	%	
Load regulation	±0.5		±1	%	5V ±1%, all others ±0.5%
Minimum load	0			%	
Ripple & noise	100	120	200	mVpp	20 MHz bandwidth, 47uF, 0.1uF cap. 100mV for 5V, 120mV for 12 & 15V, 150mV for 24V & 200mV for all others
Hold up time	10		55	ms	10ms at 115VAC, 55ms at 240VAC

LM100-23B SERIES

Protections

Parameter	Min	Typical	Max	Unit	Notes/Conditions
Overload	110		160	%	Trip and restart.
Short circuit					Trip and restart.
Overvoltage		5V model - 7.5V 12V model - 19.2V 15V model - 24V 24V model - 38.4V 36V model - 57.6V 48V model - 60V		VDC	Max figures. Hiccup

Safety

Parameter	Min	Typical	Max	Unit	Notes/Conditions
Safety standards		IEC/UL/EN 62368-1			CE/ CCC/ EN60335-1, EN61558-1, EN61558-2-16
Isolation: Input to output	4000			VAC	
Isolation: Input / output to ground	1250		2000	VAC	2000VAC from input to ground.
Insulation resistance	100			MΩ	500VDC

EMC: Immunity

	Standard	Test level	Criteria	Notes/Conditions
ESD	EN61000-4-2	3	A	±6kV contact, ±8kV air.
Radiated	EN61000-4-3	3	A	10V/m
EFT	EN61000-4-4	3	A	±2kV
Surges	EN61000-4-5	Installation class 3	A	Line to line ±2kV, common ±4kV
Conducted	EN61000-4-6	3	A	10Vrms
Voltage dips & interruptions	EN61000-4-11	0% 70%	B	

EMC: Emissions

	Standard	Test level	Criteria	Notes/Conditions
Conducted	EN55032	B		
Radiated	EN55032	B		

Environmental

Parameter	Min	Typical	Max	Unit	Notes/Conditions
Operating temperature	-30		70	°C	See derating curve.
Storage temperature	-40		85	°C	
Cooling					convection cooled
Temperature coefficient			0.03	%/°C	
Humidity	20		95	% RH	Non condensing. Storage 10-95% RH
Operating altitude			5000	M	5°C/1000m derating above 2000m
MTBF	300			kHrs	As per MIL-HDBK-217F rated load @25°C

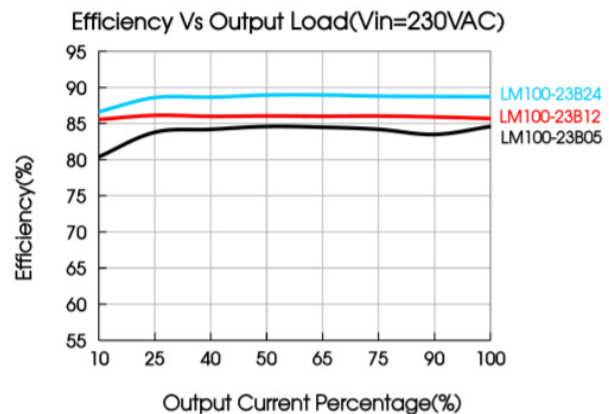
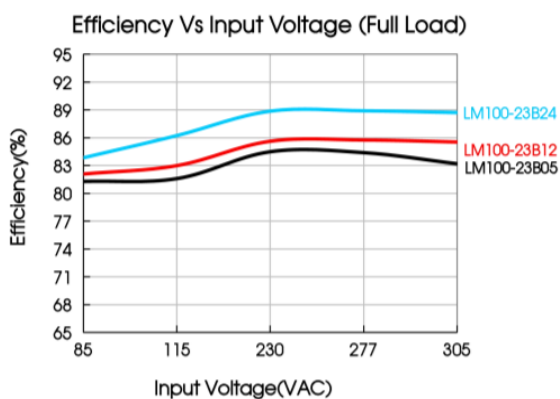
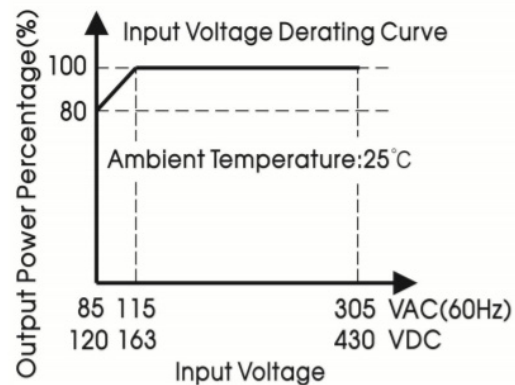
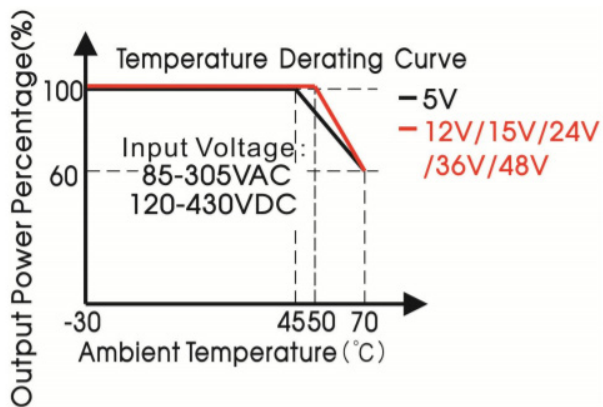

Installation Advice

EMC

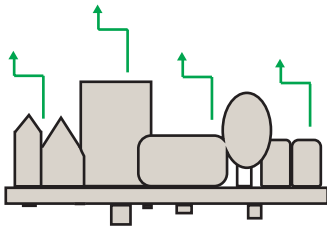

Conducted and radiated emissions compliance is a common application consideration. It is important to remember that even when using a properly filtered PSU, an application may still not achieve compliance if it is not designed to minimise emissions. That being said, there are a number of things that can be done to optimise EMC performance either as best practice, or if you are struggling for compliance:

- 1)** Connect all marked EMI ground points to earth. Often these are combined with the safety earth point (in class I installations), but on some power supplies there may be additional earth tags or mounting points.
- 2)** Minimise the length of input/output wiring where possible and try to maintain max distance of the conductors from the PSU, to prevent noise pick up. Avoid bundling input and output cables together. A common component to avoid placing wiring near is the PFC inductor in power factor corrected power supplies.
- 3)** Apply additional filtering before the PSU input (ensure consideration of which frequencies there are issues with before selecting a filter).
- 4)** When using an open frame PSU, mount the supply on a metal plate and connect EMI mounting points.
- 5)** In multi circuit systems, decouple the circuits locally.
- 6)** Ferrites added between the PSU and system input connector and/or the DC output cables can help in reducing radiated noise issues in systems. If seen, issues are commonly in the 30-150MHz area.

For more detailed assistance, if you still have any concerns with compliance, please get in contact with our Engineering department who are on hand to assist with any queries.

Thermal

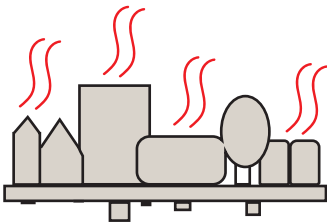

Thermal management is an important consideration when thinking about equipment service life. Electrolytic capacitors within the PSU wear with time and are typically the first end-of-life failure. Keeping the operation temperature of key components within the PSU, such as the electrolytic capacitors, as low as possible is paramount. As a general rule, for every 10°C drop in the operating temperature of the electrolytic capacitors you double their lifetime, and thus the lifetime of the power supply. When looking at thermal performance it is helpful to test under a worst-case set of conditions, to ensure component temperatures are in an acceptable range for the required service life. Then consider the impact of operational time, load and temperature profile to estimate a more realistic lifetime for your PSU.

Also, many Fidus power supplies offer a Peak Power rating to provide for customers with pulsing loads. When using a peak power capability customers must consider:

- 1)** Peak duration rating: the maximum length of time the peak can be drawn for
- 2)** Duty cycle: the frequency with which the peak can be drawn. (e.g. 10% duty cycle, 1 second on:9 seconds off)
- 3)** Average power value: datasheets will state the maximum average power acceptable with peak power PSUs. If any of these elements are exceeded the supply may overheat, with performance and lifetime suffering as a result.