

TN17-0250 SERIES

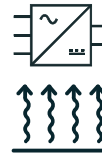

AC-DC

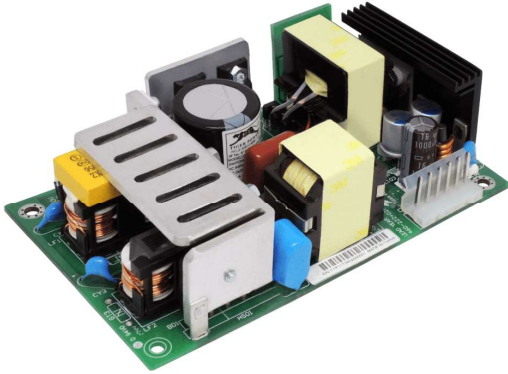

200W



250W

DIMENSIONS:

OPEN FRAME:
3 x 5 x 1.3"
(76.2 x 127 x 33mm)

EN55032 LEVEL B

UP TO 94%
EFFICIENT

IEC/UL/EN 62368-1

HIGH QUALITY
CAPACITORS

NO-LOAD <0.21W

THREE YEAR
WARRANTY

Part numbers

TN17	-	0250	12
Series		Power (W)	Output voltage
			12 = 12VDC 24 = 24VDC 48 = 48VDC 55 = 55VDC

Key specifications

Input range	Safety certification	Efficiency	Environmental performance
90-264VAC	UL/IEC/EN 62368-1	<94%	Operational: -20 to 70°C

Mechanical

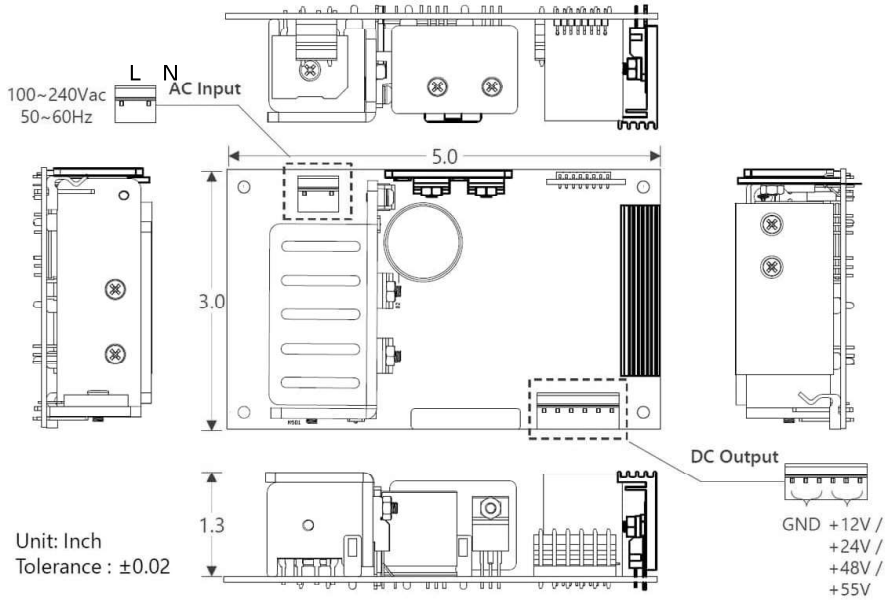

Notes

1. All dimensions shown in inches
2. Allow 10mm clearance from open frame unit
3. Ensure marked point is connected to PE

Weight

310g

11.3 CFM for 250W

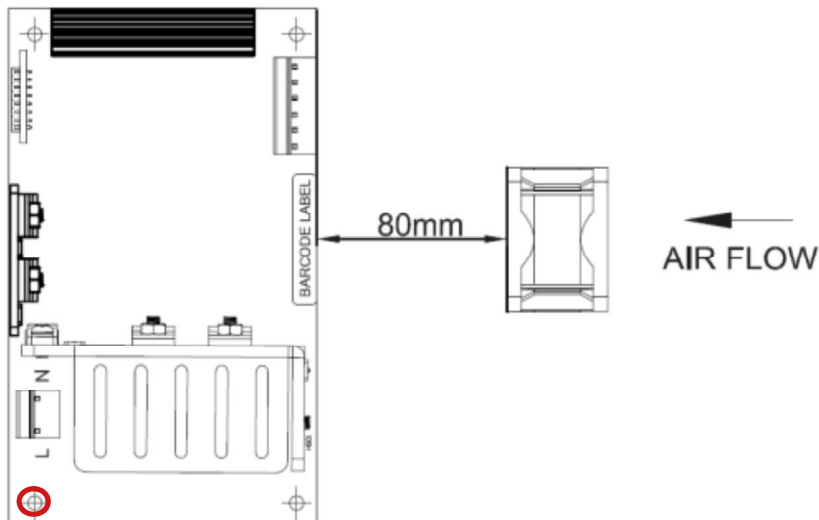

Connector

Compatible with

AC INPUT

Molex 09503031

DC OUTPUT

Molex 09503061

TN17-0250 SERIES

Models & Ratings

Model Number	Output Voltage	Power		Output Current		Efficiency ⁽¹⁾	Ripple / Noise ⁽²⁾
		Convection	11.3 CFM	Convection	11.3 CFM		
TN17-0250-12	12V	200W	250W	16.66A	20.83A	91.3%	120mV
TN17-0250-24	24V	200W	250W	8.33A	10.41A	94.2%	240mV
TN17-0250-48	48V	200W	250W	4.16A	5.20A	93.9%	480mV
TN17-0250-55	55V	200W	250W	3.63A	4.54A	93.9%	550mV

1. Minimum efficiency at 50% load 230Vac 20 min warm up

2. 0.1uF ceramic and 10uF low ESR electrolytic capacitor. 20 MHz bandwidth. At rated line and full load. Noise will be greater between 0 and -20°C

Input

Parameter	Min	Typical	Max	Unit	Notes/Conditions
Input voltage	90		264	VAC	See page 5 for derating curve
Input frequency	47		63	Hz	
Power factor			0.95		50% load 230VAC 20 mins warm up
Input current (rms)			3.5	A	115VAC/230VAC
Inrush current		50/100		A	120/240VAC cold start at 25°C
No load input power			0.21	W	

Output

Parameter	Min	Typical	Max	Unit	Notes/Conditions
Output voltage	12		55	VDC	See Models & Ratings table
Line regulation		±1		%	Rated load
Load regulation		±5		%	0-100% load
Minimum load	0		0.1	%	0.1 for 12V only
Ripple & noise		<1		%	All models measured with 0.1uF ceramic and 47uF low ESR electrolytic capacitor. 20 MHz bandwidth. At rated line and full load.
Hold up time	10			ms	25°C 115VAC 60Hz 100% load

Protections

Parameter	Min	Typical	Max	Unit	Notes/Conditions
Overload		12V model - 27 24V model - 24 48V model - 7 55V model - 6		A	Trip and restart. Automatic recovery
Short circuit					Trip and restart. Automatic recovery
Overvoltage		12V model - 15.6 24V model - 32 48V model - 60 55V model - 65		VDC	Trip and restart. Automatic recovery

Safety

Parameter	Min	Typical	Max	Unit	Notes/Conditions
Safety standards		IEC/UL/EN62368-1			
Isolation: Input to output	3000			VAC	
Isolation: Input to ground	1800			VAC	
Isolation: Output to ground	500			VAC	
Insulation resistance	20			MΩ	Rated load. 25°C ±5, RH <70% at 500VDC

EMC: Immunity

	Standard	Test level	Criteria	Notes/Conditions
ESD	EN61000-4-2	4	A	±8kV contact, ±15kV air.
Radiated	EN61000-4-3	2	A	3V/m 80MHz-2.7GHz sine wave 80% AM 1kHz
EFT	EN61000-4-4	3	A	±2kV
Surges	EN61000-4-5	Installation class 3	A	±1kV Live-Neutral, ±2kV Live/Neutral—Earth
Conducted	EN61000-4-6	2	A	3V rms
PFMF	EN61000-4-8	1	A	1A/m
Voltage dips & interruptions	EN61000-4-11	0% 0.5 cyc, 70% 25 cyc, 0% 250 cyc 230Vac 50Hz and 70% 30 cyc, 0% 300 cyc at 230Vac 60Hz A,A,B A,B		

EMC: Emissions

	Standard	Test level	Criteria	Notes/Conditions
Conducted	EN55032	B		
Radiated	EN55032	B		
Harmonic current	EN61000-3-2	Class A & D		
Voltage flicker	EN61000-3-3			

Environmental

Parameter	Min	Typical	Max	Unit	Notes/Conditions
Operating temperature	-20		70	°C	See derating curve
Storage temperature	-40		85	°C	
Cooling					Free air or 11.3CFM
Operating Altitude		5000		m	
Humidity	20		90	% RH	Non condensing. Storage 5-90%
MTBF	900			kHrs	Telcordia 25°C SR-332 issue 2

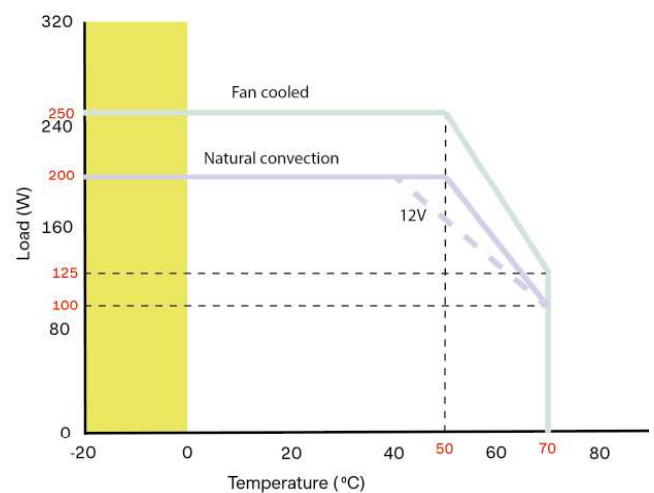
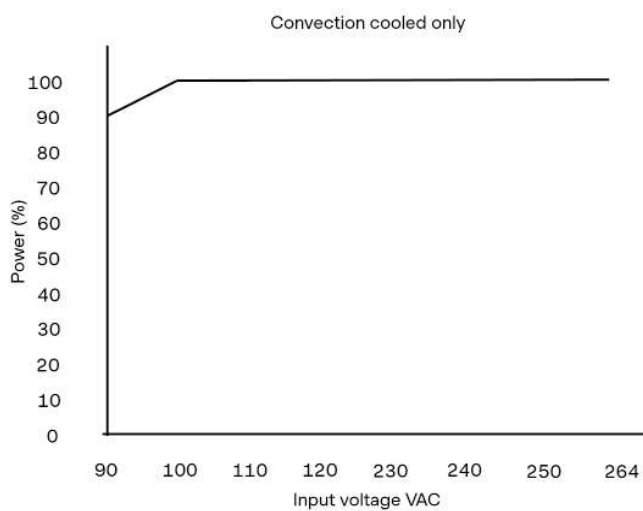

Installation Advice

Safety

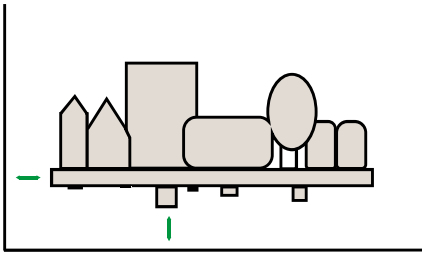

On installation customers must consider the required creepage and clearance distances between the PSU and the end-equipment enclosure. These distances vary depending on the installation class and safety standard requirements.

For **Class I** installations there should be 3-4mm between any part of the PSU and any earthed metal part of the enclosure. 3mm is acceptable for IT applications, 4mm required for medical applications. In Class I installations the PSU earth point must be connected to system safety ground.

For **Class II** installations distances may need to be increased if being installed into a surrounding metal enclosure.

Ensure consideration of components on the underside of the PCB or low lying spills when measuring clearance distances between the PSU and the end-equipment. Also top surface especially in tight enclosures such as 1U boxes. An insulation material can be used between PSU and metal if smaller gap required.

Fidus recommends installing the PSU on 6mm stand offs typically, but check the distances.

EMC

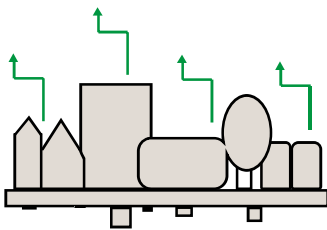

Conducted and radiated emissions compliance is a common application consideration. It is important to remember that even when using a properly filtered PSU, an application may still not achieve compliance if it is not designed to minimise emissions. That being said, there are a number of things that can be done to optimise EMC performance either as best practice, or if you are struggling for compliance:

- 1) Connect all marked EMI ground points to earth. Often these are combined with the safety earth point (in class I installations), but on some power supplies there may be additional earth tags or mounting points.
- 2) Minimise the length of input/output wiring where possible and try to maintain max distance of the conductors from the PSU, to prevent noise pick up. Avoid bundling input and output cables together. A common component to avoid placing wiring near is the PFC inductor in power factor corrected power supplies.
- 3) Apply additional filtering before the PSU input (ensure consideration of which frequencies there are issues with before selecting a filter).
- 4) When using an open frame PSU, mount the supply on a metal plate and connect EMI mounting points.
- 5) In multi circuit systems, decouple the circuits locally.
- 6) Ferrites added between the PSU and system input connector and/or the DC output cables can help in reducing radiated noise issues in systems. If seen, issues are commonly in the 30-150MHz area.

For more detailed assistance, if you still have any concerns with compliance, please get in contact with our Engineering department who are on hand to assist with any queries.

Thermal

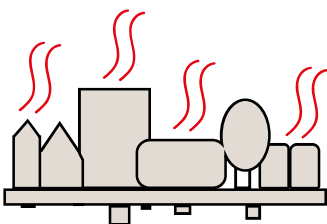

Thermal management is an important consideration when thinking about equipment service life. Electrolytic capacitors within the PSU wear with time and are typically the first end-of-life failure. Keeping the operation temperature of key components within the PSU, such as the electrolytic capacitors, as low as possible is paramount. As a general rule, for every 10°C drop in the operating temperature of the electrolytic capacitors you double their lifetime, and thus the lifetime of the power supply. When looking at thermal performance it is helpful to test under a worst-case set of conditions, to ensure component temperatures are in an acceptable range for the required service life. Then consider the impact of operational time, load and temperature profile to estimate a more realistic lifetime for your PSU.

Also, many Fidus power supplies offer a Peak Power rating to provide for customers with pulsing loads. When using a peak power capability customers must consider:

- 1) Peak duration rating: the maximum length of time the peak can be drawn for
- 2) Duty cycle: the frequency with which the peak can be drawn. (e.g. 10% duty cycle, 1 second on: 9 seconds off)
- 3) Average power value: datasheets will state the maximum average power acceptable with peak power PSUs. If any of these elements are exceeded the supply may overheat, with performance and lifetime suffering as a result.