

LOF450 SERIES

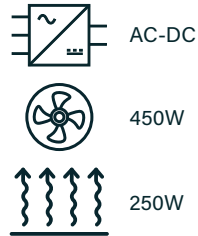

DIMENSIONS:

OPEN FRAME:
3 x 5 x 1.515"
(76.2 x 127 x 38.5mm)



EN55032 LEVEL B

FAN OR CONVECTION

2 x MOPP

LOW PROFILE

FEATURE RICH

COVERED OPTION

Part numbers

LOF	450	-	20B	12
Series	Power (W)		Input voltage	Output voltage
			90-264VAC	12 = 12VDC 15 = 15VDC 24 = 24VDC 27 = 27VDC 36 = 36VDC 48 = 48VDC 54 = 54VDC

Key specifications

Input range	Safety certification	Features	Efficiency	Environmental performance
90-264VAC	IEC/EN 62368-1 EN 60335-1 ES/EN 60601-1	Remote on/off 5V Standby Power Good Signal Remote Sense 12V fan rail Voltage adjust	91-94%	Operational: -40 to 70°C

Mechanical

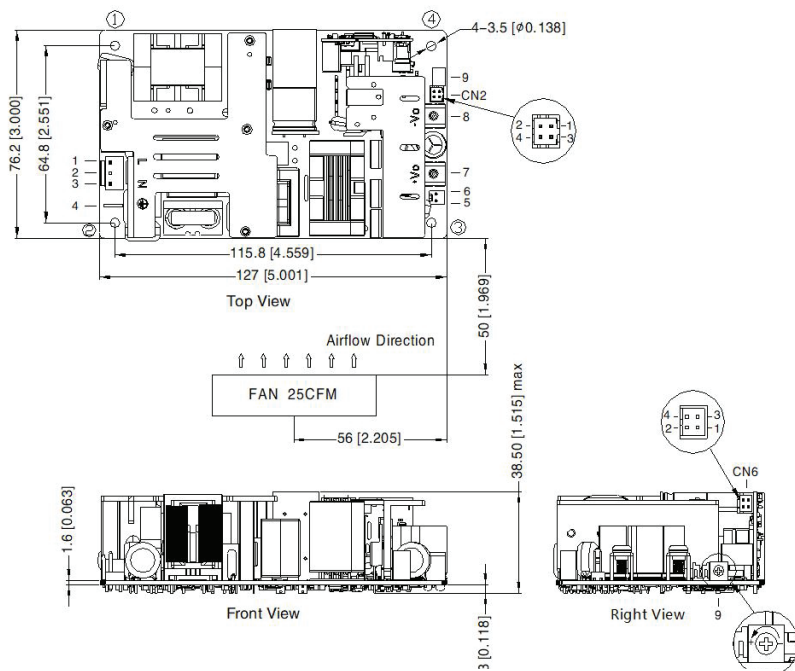

Position	Screw Spec.	L(Recommend)	Torque(max)
① - ④	M3	6mm	0.4N · m

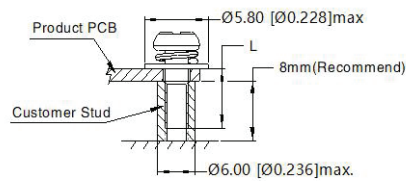

Connector	Pin/Function
Input Connector	1 AC Line 2 N/C 3 AC Neutral
Earth Connector	4 PE
CN2 Connector	1 RS- 2 RS+ 3 GND 4 PG
CN5 Fan Connector	5 Fan+ 6 Fan -
CN6 Connector	1 +5Vsb 2 GND 3 PS-ON 4 GND
Output connector	7 +Vout 8 -Vout

Notes

- All dimensions shown in mm [Inch]
- Input connector mates with JST VHR-5N
- PE connector mates with JST SPS-21T-250
- CN2 connector mates with HRS DF11-4DS-2C
- Fan connector mates with TKP 2502
- CN5 connector mates with HRS DF11-4DS-2C
- For Class I systems positions 1, 2 & 3 must be connected to earth
- General tolerance ± 1.00 [± 0.039]
- Positions 1-4 $L_{max} = 6\text{mm}$ M3 (0.4Nm)
- 10mm clearance around product is recommended for safety

Weight

400g

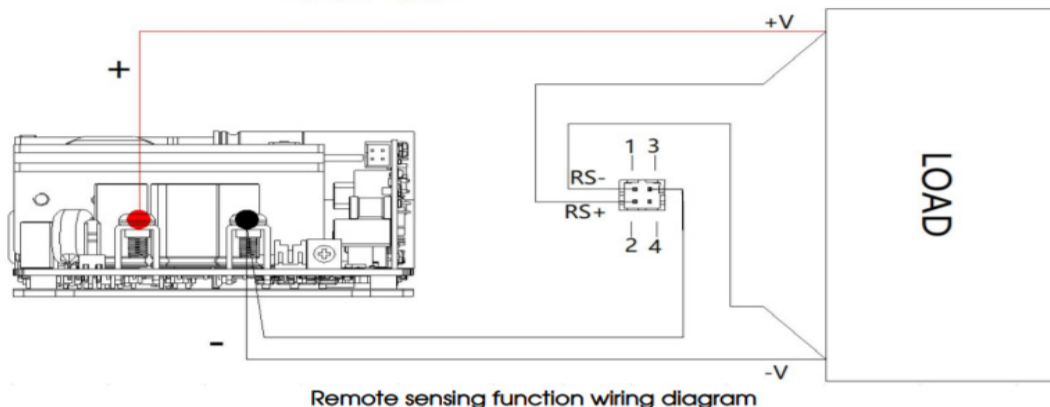



Models & Ratings

Model Number ⁽¹⁾	Output voltage	Voltage adjust	Output Power		Output Current		Efficiency ⁽²⁾	Max Cap Load
			Continuous Convection	25 CFM	Continuous Convection	25 CFM		
LOF450-20B12	12V	11.4-12.6V	250W	400W	20.8A	33.3A	91%	6000uF
LOF450-20B15	15V	14.25-15.75V	250W	400W	16.7A	26.7A	92%	6000uF
LOF450-20B24	24V	22.8-25.2V	250W	450W	10.5A	18.75A	93.5%	6000uF
LOF450-20B27	27V	25.65-28.35V	250W	450W	9.3A	16.7A	93.5%	4000uF
LOF450-20B36	36V	34.2-37.8V	250W	450W	6.95A	12.5A	93%	3000uF
LOF450-20B48	48V	45.6-50.4V	250W	450W	5.3A	9.4A	94%	2000uF
LOF450-20B54	54V	51.3-56.7V	250W	449.8W	4.63A	8.33A	94%	2000uF

1. For covered version see LOF450-C datasheet.
2. At 100% load, 230 VAC

3. Unless stated, figures are at 25°C <75RH at nom 230VAC input and full nom load.
4. At light loads, to improve efficiency, there will be an audible noise. This is not to be considered as a sign the product is defective or showing a loss in performance or reliability.



Input

Parameter	Min	Typical	Max	Unit	Notes/Conditions
Input voltage	90		264	VAC	120-370VDC also accepted. See page 5 for derating curve
Input frequency	47		63	Hz	
Power factor	0.95		0.98		EN61000-3-2 class A and D compliant. 0.95 at 230VAC and 0.98 at 115VAC
Input current (rms)			5.2 2.6	A	115VAC/230VAC
Inrush current		40/80		A	115/230VAC cold start at 25°C
No load input power			0.5	W	PS_ON at low potential
Leakage current			0.1/0.5	mA	Touch current / earth leakage at 264VAC



Output

Parameter	Min	Typical	Max	Unit	Notes/Conditions
Output voltage	12		54	VDC	See Models & Ratings table
Output voltage adjust		±5		%	See Models & Ratings table
Set point accuracy		±1 / ±2		%	12-24V ±2%, 27-54V ±1%
Line regulation		±0.5		%	Rated load
Load regulation		±1		%	0-100% load
Minimum load	0			%	
Ripple & noise			200	mV	All models measured with 0.1uF ceramic and 10uF electrolytic capacitor. 20 MHz bandwidth. At rated line and full load.
Hold up time	12	16		ms	

LOF450 SERIES

Protections

Parameter	Min	Typical	Max	Unit	Notes/Conditions
Overload	105			%	Trip and restart. Automatic recovery
Short circuit					Trip and restart. Automatic recovery <5sec
Overvoltage		12V model - 15.6V 15V model - 19.5V 24V model - 31.2V 27V model - 35.1V 36V model - 46.8V 48V model - 60V 54V model - 63V		VDC	Max figures. Latch off reset

Controls/Functions

Parameter	Min	Typical	Max	Unit	Notes/Conditions
Remote on/off	0		5	VDC	2-5VDC ON PS_ON high 0-0.5VDC OFF PS_ON low
Power Good Signal	0		6	VDC	2-6VDC - POWER ON (high) 10-500ms delay 0-0.6VDC POWER OFF (low) 1ms before 90%Vout
5V standby	0.6		1	A	0.6A convection cooled, 1A fan cooled. 2% ripple 120mVp-pmax. This includes fan power.
Remote sense					Connect at load or leave disconnected
12V fan rail	0		2	A	Includes standby current

Safety

Parameter	Min	Typical	Max	Unit	Notes/Conditions
Safety standards	ES/EN60601-1, EN60335-1, IEC/EN62368-1				Designed to meet
Isolation: Input to output	4000			VAC	2x MOPP
Isolation: Input / output to ground	1500		2000	VAC	2000VAC from input to ground. 1 x MOPP BF rated
Insulation resistance	100			MΩ	Rated load 100MΩ insulation 25°C ±5, RH <70% at 500VDC

EMC: Immunity

	Standard	Test level	Criteria	Notes/Conditions
ESD	EN61000-4-2	3	A	±8kV contact, ±15kV air.
Radiated	EN61000-4-3	3	A	10V/m 80MHz-2.7GHz sine wave 80% AM 1kHz
EFT	EN61000-4-4	3	A	±2kV
Surges	EN61000-4-5	Installation class 3	A	±2kV Live-Neutral, ±4kV Live/Neutral—Earth
Conducted	EN61000-4-6	3	A	10Vrms
Voltage dips & interruptions	EN61000-4-11		B	

EMC: Emissions

	Standard	Test level	Criteria	Notes/Conditions
Conducted	EN55032	B		CISPR22-B, FCC PART15-B
Radiated	EN55032	B		Installed on 360x360x1mm plate
Harmonic current	EN61000-3-2	Class A & D		
Voltage flicker	EN61000-3-3			

Environmental

Parameter	Min	Typical	Max	Unit	Notes/Conditions
Operating temperature	-40		70	°C	See derating curve
Storage temperature	-40		85	°C	
Cooling					Free air / 25CFM
Temperature coefficient		0.03		%/°C	
Humidity	20		90	% RH	Non condensing. Storage 10-95%
MBTF	>200			kHrs	As per MIL-HDBK-217F@25°C

LOF450-20B12/15/18/19
(full load 400W with 25CFM)

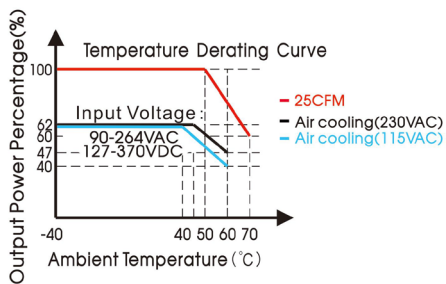

LOF450-20B24/27/36/48/54
(full load 450W with 25CFM)

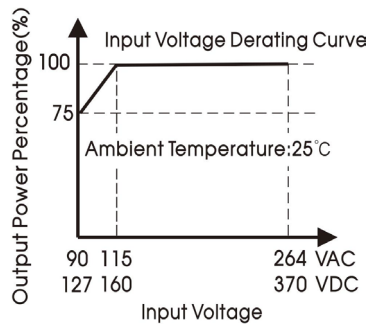

LOF450-20Bxx Input Voltage
Derating Curve

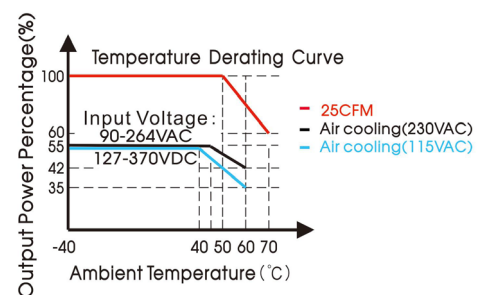

Efficiency Vs Input Voltage (Full Load)

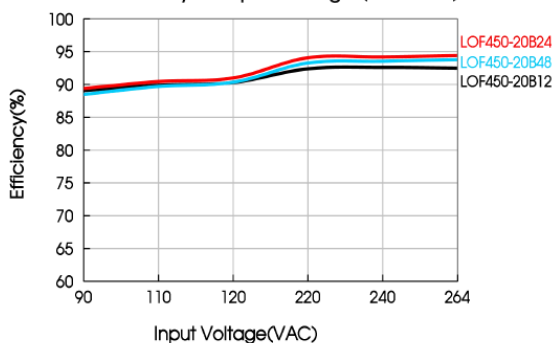

Efficiency Vs Output Load

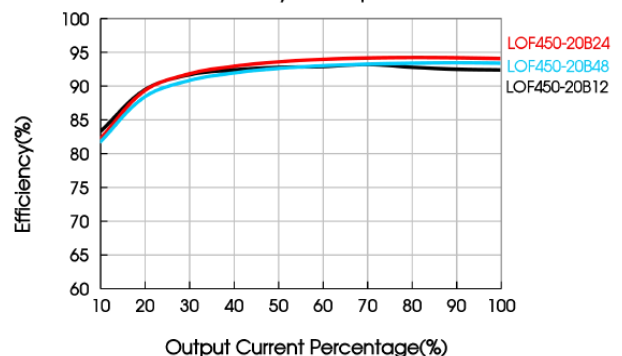

Installation Advice

Safety

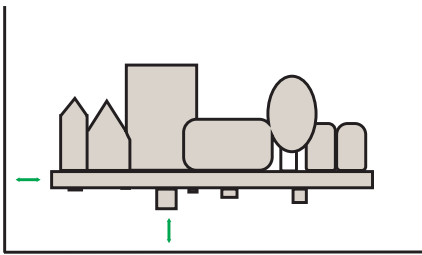

On installation customers must consider the required creepage and clearance distances between the PSU and the end-equipment enclosure. These distances vary depending on the installation class and safety standard requirements.

For **Class I** installations there should be 3-4mm between any part of the PSU and any earthed metal part of the enclosure. 3mm is acceptable for IT applications, 4mm required for medical applications. In Class I installations the PSU earth point must be connected to system safety ground.

For **Class II** installations distances may need to be increased if being installed into a surrounding metal enclosure.

Ensure consideration of components on the underside of the PCB or low lying spills when measuring clearance distances between the PSU and the end-equipment. Also top surface especially in tight enclosures such as 1U boxes. An insulation material can be used between PSU and metal if smaller gap required.

Fidus recommends installing the PSU on 6mm stand offs typically, but check the distances.

EMC

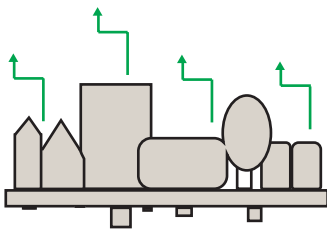

Conducted and radiated emissions compliance is a common application consideration. It is important to remember that even when using a properly filtered PSU, an application may still not achieve compliance if it is not designed to minimise emissions. That being said, there are a number of things that can be done to optimise EMC performance either as best practice, or if you are struggling for compliance:

- 1) Connect all marked EMI ground points to earth. Often these are combined with the safety earth point (in class I installations), but on some power supplies there may be additional earth tags or mounting points.
- 2) Minimise the length of input/output wiring where possible and try to maintain max distance of the conductors from the PSU, to prevent noise pick up. Avoid bundling input and output cables together. A common component to avoid placing wiring near is the PFC inductor in power factor corrected power supplies.
- 3) Apply additional filtering before the PSU input (ensure consideration of which frequencies there are issues with before selecting a filter).
- 4) When using an open frame PSU, mount the supply on a metal plate and connect EMI mounting points.
- 5) In multi circuit systems, decouple the circuits locally.
- 6) Ferrites added between the PSU and system input connector and/or the DC output cables can help in reducing radiated noise issues in systems. If seen, issues are commonly in the 30-150MHz area.

For more detailed assistance, if you still have any concerns with compliance, please get in contact with our Engineering department who are on hand to assist with any queries.

Thermal

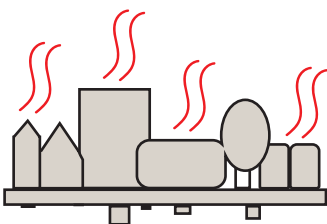

Thermal management is an important consideration when thinking about equipment service life. Electrolytic capacitors within the PSU wear with time and are typically the first end-of-life failure. Keeping the operation temperature of key components within the PSU, such as the electrolytic capacitors, as low as possible is paramount. As a general rule, for every 10°C drop in the operating temperature of the electrolytic capacitors you double their lifetime, and thus the lifetime of the power supply. When looking at thermal performance it is helpful to test under a worst-case set of conditions, to ensure component temperatures are in an acceptable range for the required service life. Then consider the impact of operational time, load and temperature profile to estimate a more realistic lifetime for your PSU.

Also, many Fidus power supplies offer a Peak Power rating to provide for customers with pulsing loads. When using a peak power capability customers must consider:

- 1) Peak duration rating: the maximum length of time the peak can be drawn for
- 2) Duty cycle: the frequency with which the peak can be drawn. (e.g. 10% duty cycle, 1 second on: 9 seconds off)
- 3) Average power value: datasheets will state the maximum average power acceptable with peak power PSUs. If any of these elements are exceeded the supply may overheat, with performance and lifetime suffering as a result.