

MULP180 Series

180 Watts

- Ultra low profile 0.75"
- IEC60601-1-2 4th ed Immunity, EN60601-1 and BF rated
- 120W Convection cooled / 180W Fan cooled
- Cover kit available
- Power good and AC power fail output signal option
- EN55011 Level B conducted & radiated
- 5 Year warranty

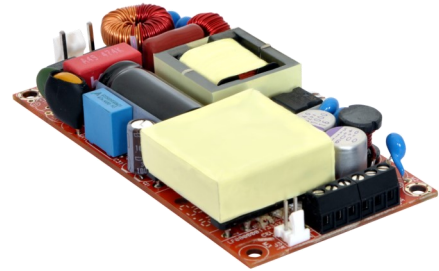

Dimensions:

4 x 2 x 0.75" (101.6 x 50.8 x 19.05mm)

The MULP120 series of ultra low profile, open frame medical AC-DC power modules offer 110-120W convection cooled and 180W fan cooled in a 4" x 2" package. The units are fully featured including screw terminal, output signal option (power good, AC power fail option) and cover option⁽⁶⁾. They are chassis mount, low noise, latest medical approvals, with a wide operating temperature of -40 to 70°C, in a range of voltages from 12V to 58V and all come with a FIDUS 5 year warranty.

Models & Ratings

INSTALLATION ADVICE PG5

Model Number ⁽²⁾	Output Power	Output voltage	Output Current			Efficiency ⁽³⁾
			Convection at 50° C	Convection at 40° C	300LFM Fan cooled	
MULP180- <u>13</u> 12	180W	12V	9.37A	10.00A	15.00A	88%
MULP180- <u>13</u> 15	180W	15V	7.50A	8.00A	12.00A	88%
MULP180- <u>13</u> 24	180W	24V	4.68A	5.00A	7.50A	90%
MULP180- <u>13</u> 30	180W	30V	3.75A	4.00A	6.00A	90%
MULP180- <u>13</u> 48	180W	48V	2.34A	2.50A	3.75A	92%

Notes

1. For screw terminal version replace 3 above for 0. Example 'MULP180-1012' for power good and AC power fail version change 1 above for 0. Example 'MULP180-0012'
2. Combined output power is main un DC output + fan output (12V 0.5A)
3. 58V unit also available, please contact sales
4. At 100% load, 230VAC
5. Cover kit available ULP180-CK / ULP180CKP for PF/AC fail version * cover kit derates unit to 70%
6. Loom kits available. See 'Installation Advice' on pg5
7. For class II versions please contact sales

Key specifications

Parameter	Minimum	Typical	Maximum	Units	Notes & Conditions
AC Input range	80		264	VAC	Derate from 100% at 100VAC to 77% at 80VAC
Operating temperature	-40		70	°C	See derating curve p3. Ripple can be 10% or more between -40 and 0°C, start-up guaranteed.
Efficiency	See ratings table above				
Dimensions	4 x 2 x 0.75" (101.6 x 50.8 x 19.05mm)				
EMC	EN55011 Level B conducted and radiated EN61000-3 and EN61000-4, harmonics, flicker, Surge, EFT, ESD, conducted and radiated. IEC60601-1-2 4th ed Immunity				
Safety	EN/IEC/ANSI/AAMI ES60601-1, CSA C22.2 No60601-1, CE.				

MULP180 Series

Input

Parameter	Minimum	Typical	Maximum	Units	Notes & Conditions
Input voltage	80		264	VAC	Derate from 100% at 100VAC to 77% at 80VAC
Input frequency	47		63	Hz	
Power factor	0.9		0.95		EN61000-3-2 class A compliant, 0.9 at 115VAC, 0.95 at 240VAC
Input current (rms)			2.2	A	At 115VAC
			1.1		At 230VAC max
Inrush current			<25	A	115VAC cold start at 25°C
			<45		230VAC cold start at 25°C
No load input power		<0.5 / 0.85		W	<0.85W for power good / AC power fail version

Output

Parameter	Minimum	Typical	Maximum	Units	Notes & Conditions
Output voltage	12		58	VDC	See Model & Ratings table
Output Voltage Adjust		±3		%	
Set point accuracy			±1	%	
Line regulation			±0.5	%	
Load regulation			±1	%	
Minimum load	0			%	
Transient response			4	%	25% step change, 0.1A/uS slew, 50% duty 50hz, in 5ms
Ripple & Noise			1	%	All models measured with 0.1uF ceramic and 10uF electrolytic capacitor. 20 MHz bandwidth. At rated line and full load
Hold up time	10		16	mS	10mS at 180W, 16mS at 120W
Overload protection	110			%	
Short circuit protection					Trip and restart. Automatic recovery
Overvoltage protection	110		140	%	Latching, requires manual power reset.
Leakage current		300		uA	
Touch current			100	uA	

General

Parameter	Minimum	Typical	Maximum	Units	Notes & Conditions
Efficiency	Please see ratings table on page 1				
Isolation: Input to Output	4000			VAC	
Input to Ground	1500			VAC	N/A for class II version
Output to Ground	1500			VAC	500VAC for type B. N/A for class II version
Switching frequency	50		80	KHz	For power switching. PFC switching: 70-130KHz
Power density			16.95	W/In ³	
MTBF	>3.37			MHrs	As per Telcordia-SR332- issue 3
Weight			200	g	

Environmental

Parameter	Minimum	Typical	Maximum	Units	Notes & Conditions
Operating temperature	-40		70	°C	Derate above 50°C at 2.5% per °C Please see derating curve on page 3
Storage temperature	-40		85	°C	
Cooling					Convection cooled / fan cooled 300LFM
Altitude	16000		40000	ft	16000ft operating 40000ft non operating
Humidity	5		95	% RH	Non condensing

Power Derating Curve

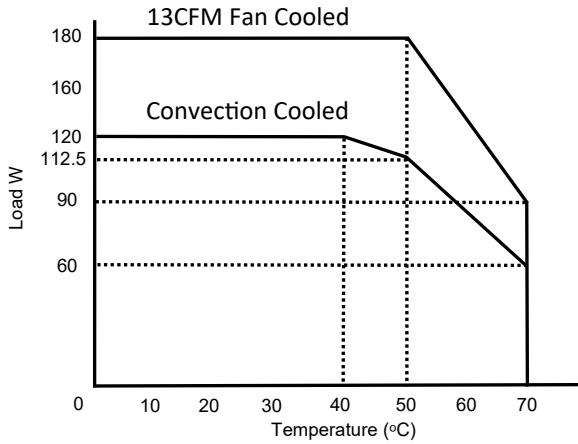

AC Input Derating Curve

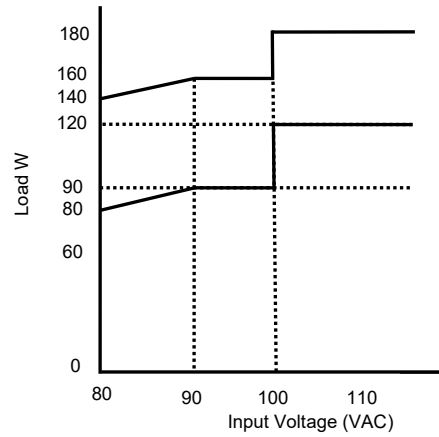

EMC: Emissions

	Standard	Test level	Criteria	Notes & Conditions
Conducted	EN55011	B		CISPR22-B, FCC PART15-B
Radiated	EN55011	B		With ferrite king core K5B RC 25x12x15-M on input
Harmonic current	EN61000-3-2	Class D		
Voltage flicker	EN61000-3-3			

EMC: Immunity

	Standard	Test level	Criteria	Notes & Conditions
ESD	EN61000-4-2	4	A	15KV Air, 8KV Contact
Radiated	EN61000-4-3	3	A	10V/m 80MHz-2.7GHz sine wave 80% AM 1KHz
EFT	EN61000-4-4	3	A	2KV Power, 1KV I/O 5KHz (Ed4)
Surges	EN61000-4-5	Installation Class 3	A	1KV Live-Neutral, 2KV Live/Neutral—Earth
Conducted	EN61000-4-6	3	A	10V, 0.15 to 80MHz sine wave 80AM 1KHz
Magnetic Fields	EN61000-4-8	4	A	30A/m 50Hz
Voltage Dips and Interruptions	EN61000-4-11		B	

Safety Approvals

	Safety standard	Notes & Conditions
UL	ANSI/AAMI ES60601-1 (3rd ed), CSA 22.2 No 60601-1	UL file E173812, VOL D1
CB	IEC 60601-1 3rd Ed	Class I CB Test cert NO 94796, Class II NO 94850
Nemko	EN 60601-1 3rd Ed	Class I Nemko No P16221541, Class II P16221548
CE		2011/65/EU RoHS Directive and 2014/35/EU Low voltage directive
Equipment protection class		Class I (please contact sales for class II versions)

Mechanical Details

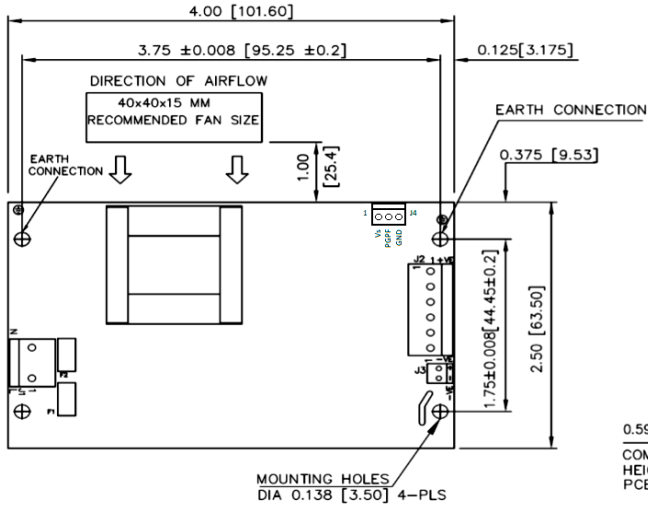

Screw terminal version
(on request)

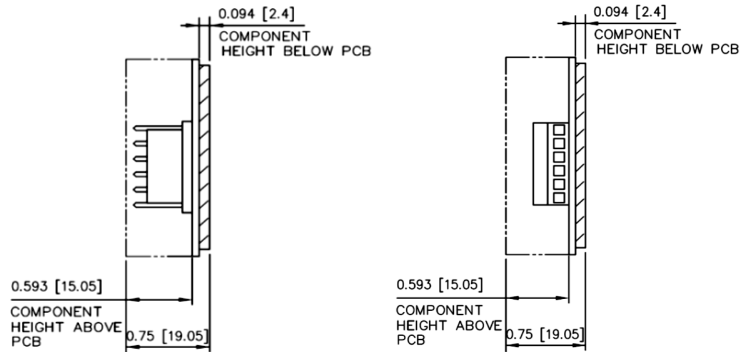

J1: Input Connector ⁽²⁾	
Pin Connections	
Pin	Function
1	AC Line
2	AC Neutral

J2: Output Connector ⁽³⁾	
Pin Connections	
Pin	Function
1	+Vout
2	+Vout
3	+Vout
4	-Vout
5	-Vout
6	-Vout

J3: Fan Connector ⁽⁴⁾	
Pin Connections	
Pin	Function
1	Fan +
2	Fan -

J4: Optional PGPF Connector ⁽⁵⁾	
Pin Connections	
Pin	Function
1	AC OK
2	PGPF
3	GND

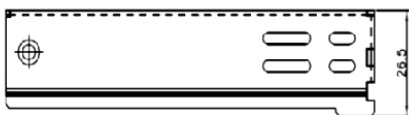
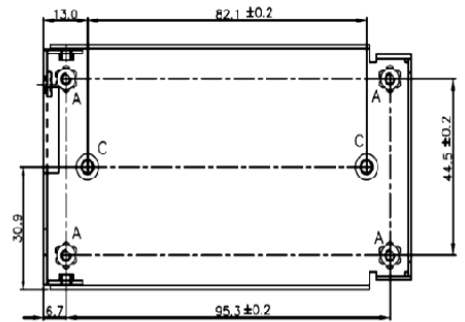
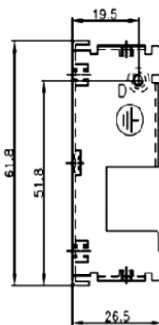
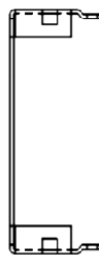
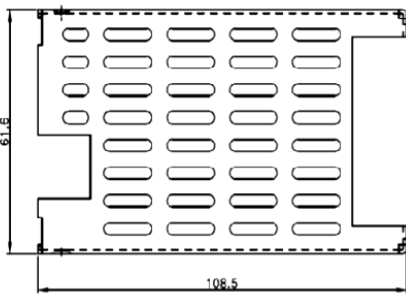

Screw	Description	Detail	Qty
A	PCB mounting	PNHD M3 6mm	4
B	Mates with D	PNHD M3 6mm	2
C	Case mount (screws not supplied)	M3 x 0.5 thread 3mm deep	2

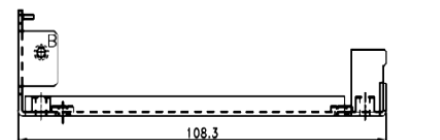

Notes

- All dimensions shown in Inches [mm], case dims in mm
- J1: Input connector details: Molex: 26-60-4030 mating part: Molex: 09-50-3031 or equivalent
- J2: Output connector details: Molex: 26-60-4060 mating part Molex: 09-50-3061 or equivalent

- J3: Output connector details: AMP: 640456-2 mating part AMP: 640440-2 or equivalent
- J4: Optional output connector details: AMP: 640456-3 mating part AMP: 640440-2 or equivalent
- Case supplied with mylar insulator

Installation Advice

Safety

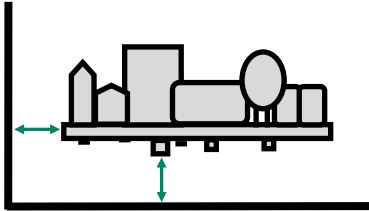

On installation customers must consider the required creepage and clearance distances between the PSU and the end-equipment enclosure. These distances vary depending on the installation class and safety standard requirements.

For **Class I** installations there should be 3-4mm between any part of the PSU and any earthed metal part of the enclosure. 3mm is acceptable for IT applications, 4mm required for medical applications. In Class I installations the PSU earth point must be connected to system safety ground.

For **Class II** installations distances may need to be increased if being installed into a surrounding metal enclosure.

Ensure consideration of components on the underside of the PCB or low lying spills when measuring clearance distances between the PSU and the end-equipment. Also top surface especially in tight enclosures such as 1U boxes. An insulation material can be used between PSU and metal if smaller gap required.

FiDUS recommends installing the PSU on 6mm stand offs typically, but check the distances.

EMC

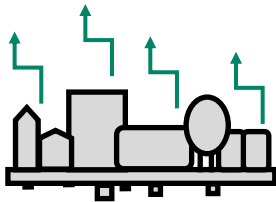

Conducted and radiated emissions compliance is a common application consideration. It is important to remember that even when using a properly filtered PSU, an application may still not achieve compliance if it is not designed to minimise emissions. That being said, there are a number of things that can be done to optimise EMC performance either as best practice, or if you are struggling for compliance:

- 1) Connect all marked EMI ground points to earth. Often these are combined with the safety earth point (in class I installations), but on some power supplies there may be additional earth tags or mounting points.
- 2) Minimise the length of input/output wiring where possible and try to maintain max distance of the conductors from the PSU, to prevent noise pick up. Avoid bundling input and output cables together. A common component to avoid placing wiring near is the PFC inductor in power factor corrected power supplies.
- 3) Apply additional filtering before the PSU input (ensure consideration of which frequencies there are issues with before selecting a filter).
- 4) When using an open frame PSU, mount the supply on a metal plate and connect EMI mounting points.
- 5) In multi circuit systems, decouple the circuits locally.
- 6) Ferrites added between the PSU and system input connector and/or the DC output cables can help in reducing radiated noise issues in systems. If seen, issues are commonly in the 30-150MHz area.

For more detailed assistance, if you still have any concerns with compliance, please get in contact with our Engineering department who are on hand to assist with any queries.

Thermal

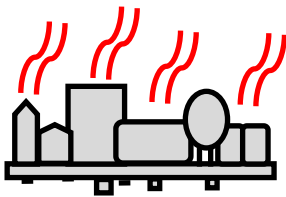

Thermal management is an important consideration when thinking about equipment service life. Electrolytic capacitors within the PSU wear with time and are typically the first end-of-life failure. Keeping the operation temperature of key components within the PSU, such as the electrolytic capacitors, as low as possible is paramount. As a general rule, for every 10°C drop in the operating temperature of the electrolytic capacitors you double their lifetime, and thus the lifetime of the power supply. When looking at thermal performance it is helpful to test under a worst-case set of conditions, to ensure component temperatures are in an acceptable range for the required service life. Then consider the impact of operational time, load and temperature profile to estimate a more realistic lifetime for your PSU.

Also, many FiDUS power supplies offer a *Peak Power* rating to provide for customers with pulsing loads. When using a peak power capability customers must consider:

- 1) Peak duration rating: the maximum length of time the peak can be drawn for
- 2) Duty cycle: the frequency with which the peak can be drawn. (e.g. 10% duty cycle, 1 second on:9 seconds off)
- 3) Average power value: datasheets will state the maximum average power acceptable with peak power PSUs. If any of these elements are exceeded the supply may overheat, with performance and lifetime suffering as a result.

Connectivity

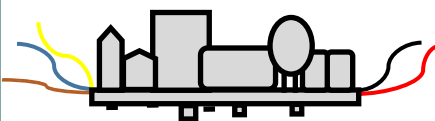

All FiDUS Power engineering samples requested will arrive with a free of charge loom kit for ease of testing.

The loom kit connects to the input/output terminals of the PSU and provides the customer with bare wire ends to connect with.

The loom kits can also prove advantageous for ease of installation in production. Please contact sales if you are interested in including the loom kit in your quotation. Alternatively the input/output connector and mating part details can be found in the attached table.

	Part Number	Mating Part Number
Input	Molex: 26-60-4030	Molex: 09-50-3031
Output	Molex: 26-60-4060	Molex: 09-50-3061
Loom Kit	ULP180-LK	