

700 Watts

- High power density 3.66 x 7.16"
- -30°C to 70°C operation
- 5V 1A Standby
- Remote on/off, Remote sense
- Output Voltage Adjust $\pm 4\%$
- Power Good signal
- 5 Year warranty



The VQF700 series of compact enclosed AC-DC PSUs that provide 600-700W from a fan cooled 3.66 x 7.16" package. The range is approved for use in both IT and industrial applications and is available in a range of 12 to 54V output. The units are fully featured with 5V standby rail, remote on/off, power good signal and remote sense. All with a FIDUS 5 year warranty.

Dimensions:

3.66 x 7.16 x 1.61" (93 x 182 x 41mm)

Models & Ratings

INSTALLATION ADVICE PG5

Model Number ⁽¹⁾	Output Power	Output voltage	Output Current	Efficiency ⁽²⁾	Capacitive Load	Ripple and Noise ⁽³⁾
VQF70012	625W	12V	52.08A	89%	5,000uF	160mV
VQF70015	625W	15V	41.66A	90%	3,750uF	160mV
VQF70024	700W	24V	29.16A	91%	2,500uF	240mV
VQF70048	700W	48V	25.00A	92%	2,000uF	280mV
VQF70054	700W	54V	14.58A	92%	1,250uF	480mV

Notes

1. Add -I for current share option for paralleling units
2. Efficiency is at full load nominal input
3. Ripple and noise measured with 20MHz bandwidth, 6" twisted pair wit 0.1uF and 47uF capacitor

Key specifications

Parameter	Minimum	Typical	Maximum	Units	Notes & Conditions
AC Input range	90		264	VAC	Full power to 115VAC, then derate linearly to 75% at 90VAC. See derating curve P3
Operating temperature	-30		70	°C	Derate linearly from 100% power at 50°C to 40% power at 70°C. Full power to -20°C then 70% at -30°C See derating curve P3
Efficiency	89		92	%	
Dimensions	3.66 x 7.16 x 1.61" (93 x 182 x 41mm)				
EMC	EN55032/11 Level B conducted and radiated. EN61000-3 and EN61000-4, harmonics, flicker, Surge, EFT, ESD, conducted and radiated. IEC/EN 60601-1-2 4th edition				
Safety	UL/CSA/IEC/EN 62368-1, CE-LVD				

Input

Parameter	Minimum	Typical	Maximum	Units	Notes & Conditions
Input voltage	90		264	VAC	Full power to 115VAC, then derate linearly to 75% at 90VAC. See derating curve P3
Input frequency	50		60	Hz	
Power factor	0.9				EN61000-3-2 class A compliant
Input current		3.5/8		A	3.5A at 230VAC, 8A at 115VAC
Inrush current		<55/90		A	115/230 VAC cold start at 25°C
Leakage current			<100	uA	

Output					
Parameter	Minimum	Typical	Maximum	Units	Notes & Conditions
Output voltage	12		54	VDC	See Model & Ratings table
Set point accuracy			±2	%	
Line regulation			±0.5	%	High line to low line
Load regulation		±1		%	Switching from 10% load to 100% load
Output trim		±4		%	
Minimum load	1			%	
Ripple & Noise	160		480	mVp-p	See ratings table
Hold up time	5			mS	At rated load and 115VAC
Overload protection					Trip & restart. Automatic recovery
Overvoltage protection					Trip & restart. Automatic recovery
Temperature protection					Trip & restart. Automatic recovery
Short circuit protection					Latch off and auto recovery for low current trip
Power good	Power OK 3.7-5.7V, power not OK 0-1V				
5V stand by	0.6A, tolerance 10%, ripple and noise 100mVpk-pk				
Remote control	Link +RC and -RC for off				
Remote sense	Compensation to 5V max				

General					
Parameter	Minimum	Typical	Maximum	Units	Notes & Conditions
Efficiency	89		92	%	See models & Ratings table
Isolation: Input to Output	4000			VAC	Or 5656VDC. 2 x MOPP
Input to Ground	2000			VAC	
Output to Ground	1500			VAC	
Power density			16.59	W/In ³	
MTBF	100			Khrs	MIL-HDBK-217F 25°C
Weight		890		g	

Environmental					
Parameter	Minimum	Typical	Maximum	Units	Notes & Conditions
Operating temperature	-30		70	°C	Derate linearly from 100% power at 50°C to 40% power at 70°C. Full power to -20°C then 70% at -30°C See derating curve P3
Storage temperature	-35		85	°C	
Altitude			5000	m	
Pressure	56		106	kPa	
Temperature coefficient	0.03		0.06	%/°C	0.03 from 0 to 50°C and 0.06 from -30 to 0°C
Humidity	5		95	%RH	Non-condensing
Vibration	10-500Hz, 2G 10min/cycle, 60 min. X,Y and Z axes				

Thermal derating curve

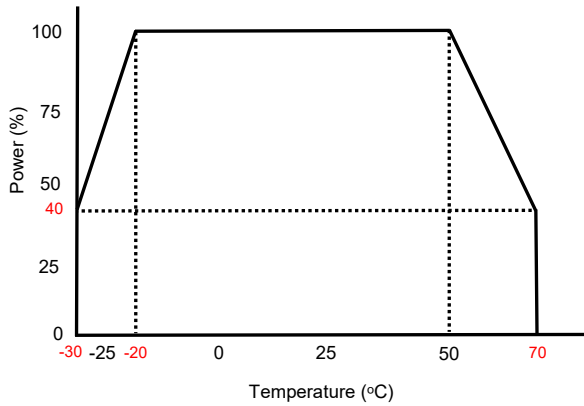

AC input derating curve

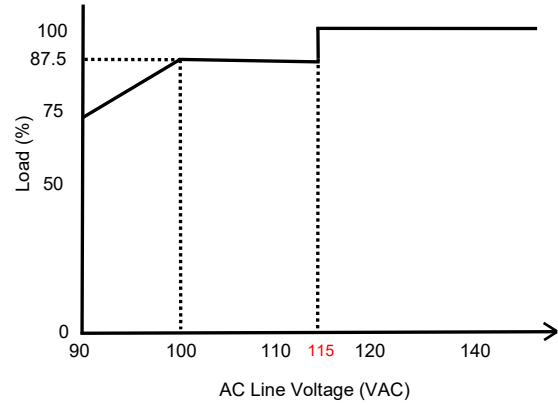

EMC: Emissions

	Standard	Test level	Criteria	Notes & Conditions
Conducted	EN55022	B		
Radiated	EN55022	A		
Harmonic current	EN61000-3-2	Class A		
Voltage flicker	EN61000-3-3			

EMC: Immunity

	Standard	Test level	Criteria	Notes & Conditions
ESD	EN61000-4-2	1/2	A	±2kV contact, ±4kV air
Radiated	EN61000-4-3	2	A	3V/m
EFT	EN61000-4-4	2	A	1KV
Surges	EN61000-4-5	Installation Class 3	A	1KV Line to Neutral, 2KV Line/neutral to PE
Conducted	EN61000-4-6	2	A	3Vrms
PFMF	EN61000-4-8	1	A	1A/m
Dips and interruptions	EN61000-4-11	95% 250 cycles, 30% 25 cycles, 95% 0.5 cycles. Per criteria B,A,A		

Safety Approvals

	Safety standard	Notes & Conditions
UL	UL/CSA 62368-1	
Other	IEC/EN 62368-1	2014/35/EU Low voltage directive
Equipment protection class		Class I

Application note

Power good signal

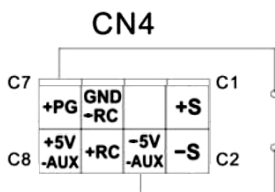

Remote on/off function

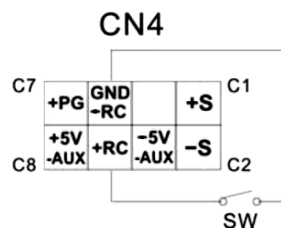

Remote sense

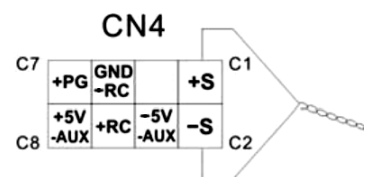

Mechanical Details

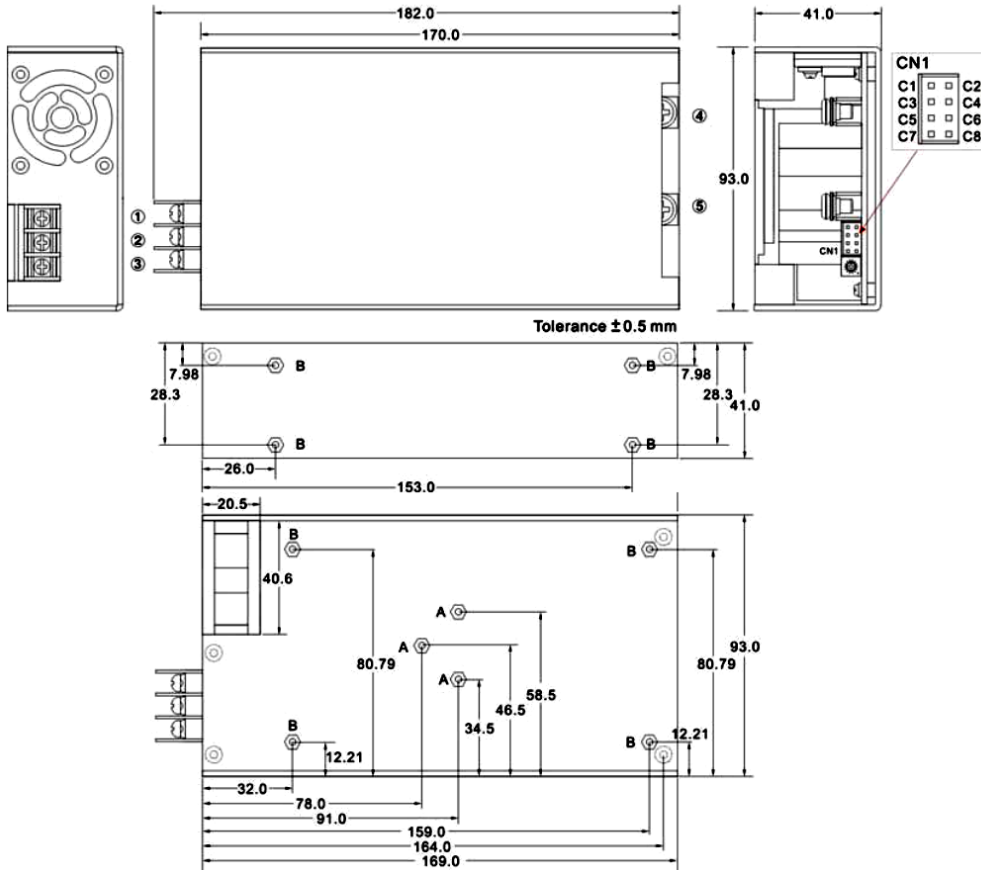

Pin Connections—Input	
Pin	Function
1	Earth
2	Neutral
3	Line

Pin Connection main output ⁽³⁾	
Pin	Function
4	+V
5	-V

Pin Connections CN1 ⁽⁴⁾	
Pin	Function
C1	+S
C2	-S
C3	CS
C4	-5V Aux
C5	GND/-RC
C6	+RC
C7	+PG
C8	+5V Aux

Notes

1. All dimensions in mm
2. When installing it is advised to use no more than 2.5mm of thread on the mounting points
3. Output connection is M5 pan head. Torque to 8 lbs-in or 90cNM
4. CN4 pin detail: 2mm pitch Ø0.8mm mating part TE 2-111626-4
5. All thread inserts M3 0.5mm pitch
6. CS Current share optional with adding “-I” to part number

Application note: Current share

1. No more than 2 units should be paralleled. If more required please contact sales.
2. Derate by 90% total output power
3. Minimum load 15%
4. Check output voltage of each unit is within 0.2V

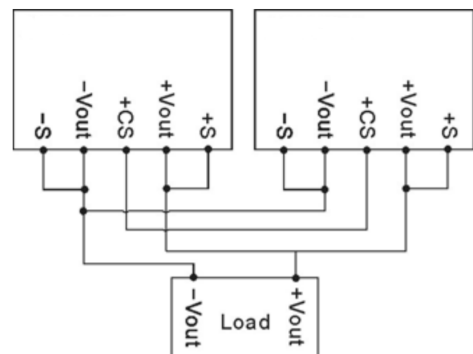

Installation Advice

Safety

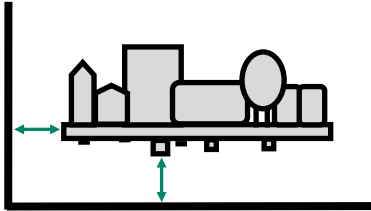

On installation customers must consider the required creepage and clearance distances between the PSU and the end-equipment enclosure. These distances vary depending on the installation class and safety standard requirements.

For **Class I** installations there should be 3-4mm between any part of the PSU and any earthed metal part of the enclosure. 3mm is acceptable for IT applications, 4mm required for medical applications. In Class I installations the PSU earth point must be connected to system safety ground.

For **Class II** installations distances may need to be increased if being installed into a surrounding metal enclosure.

Ensure consideration of components on the underside of the PCB or low lying spills when measuring clearance distances between the PSU and the end-equipment. Also top surface especially in tight enclosures such as 1U boxes. An insulation material can be used between PSU and metal if smaller gap required.

FiDUS recommends installing the PSU on 6mm stand offs typically, but check the distances.

EMC

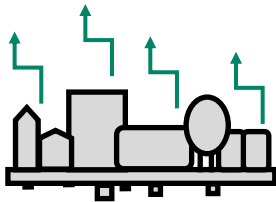

Conducted and radiated emissions compliance is a common application consideration. It is important to remember that even when using a properly filtered PSU, an application may still not achieve compliance if it is not designed to minimise emissions. That being said, there are a number of things that can be done to optimise EMC performance either as best practice, or if you are struggling for compliance:

- 1) Connect all marked EMI ground points to earth. Often these are combined with the safety earth point (in class I installations), but on some power supplies there may be additional earth tags or mounting points.
- 2) Minimise the length of input/output wiring where possible and try to maintain max distance of the conductors from the PSU, to prevent noise pick up. Avoid bundling input and output cables together. A common component to avoid placing wiring near is the PFC inductor in power factor corrected power supplies.
- 3) Apply additional filtering before the PSU input (ensure consideration of which frequencies there are issues with before selecting a filter).
- 4) When using an open frame PSU, mount the supply on a metal plate and connect EMI mounting points.
- 5) In multi circuit systems, decouple the circuits locally.
- 6) Ferrites added between the PSU and system input connector and/or the DC output cables can help in reducing radiated noise issues in systems. If seen, issues are commonly in the 30-150MHz area.

For more detailed assistance, if you still have any concerns with compliance, please get in contact with our Engineering department who are on hand to assist with any queries.

Thermal

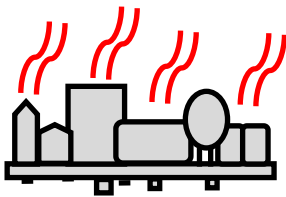

Thermal management is an important consideration when thinking about equipment service life. Electrolytic capacitors within the PSU wear with time and are typically the first end-of-life failure. Keeping the operation temperature of key components within the PSU, such as the electrolytic capacitors, as low as possible is paramount. As a general rule, for every 10°C drop in the operating temperature of the electrolytic capacitors you double their lifetime, and thus the lifetime of the power supply. When looking at thermal performance it is helpful to test under a worst-case set of conditions, to ensure component temperatures are in an acceptable range for the required service life. Then consider the impact of operational time, load and temperature profile to estimate a more realistic lifetime for your PSU.

Also, many FiDUS power supplies offer a *Peak Power* rating to provide for customers with pulsing loads. When using a peak power capability customers must consider:

- 1) Peak duration rating: the maximum length of time the peak can be drawn for
- 2) Duty cycle: the frequency with which the peak can be drawn. (e.g. 10% duty cycle, 1 second on:9 seconds off)
- 3) Average power value: datasheets will state the maximum average power acceptable with peak power PSUs. If any of these elements are exceeded the supply may overheat, with performance and lifetime suffering as a result.